

Minutes

Meeting Referee Commission 30 July/1 August 2015 in Bucarest

Presence:

Guests: A. Pascu, Ao Jie , N. Rodriguez *, K. Kulczar * (* a times)

RC: all members were present

1) Welcome

The RC chair welcomed all and proposed the points 3), 7) and 9) to discuss as one block. It was agreed.

2) Minutes RC Madrid

No any .remarks.

3) Flashback competitions (WC/GP, Continental Championships, WCH Moscow)

On the basis of the analysis of reports season 2014-15 the commission discussed the performance of the referees and the problems during the different competitions.

4) Flashback exams 2015

On the basis of a summery of all exams after the OG 2012 ([see attachment](#)) the current status has been discussed.

The commission agreed that in the season 2015-16 will not be effect referees exams but for these referees with a current P-status the commission intents to offer for them opportunities to finish their exams by a P-observation. This should be possible at:

- Continental Championships Jun/Cad
- JWC Bratislava/SVQ et Udine/ITA
- Other FIE Junior competition where the presence of two members of RC or one member of RC and one elite referee from this weapon will be happen

5) Evaluation proposals Congress 2015

The commission formed his opinion following: ([see attachment](#))

6) Preparation further activities 2015-16

RC intents to effects the next RC meeting at 26/27 September 2015 in Moscow.

Agenda: Designations FIE competitions from 1 January 2016, activities RC (seminars, P-observations), A-Grade, Further

7) Masterlist /elite 2015-16

After intensive discussion RC is proposing the list ([see attachment](#))

8) Education program RC / working group

Following the info-letter FIE intents to establish a working group were is tasked to prepare a Education Program for development referees. RC is proposing as their cooperators: I.Knysch, S.Ferjani, C.Janka

9) Designations WC/GP 2015, OG Rio

After intensive discussion RC is proposing the referees list ([see attachment](#))

RC delegates were designated on base of a proposal of the President of commission. With no objection from any member of the refereeing commission and no body asking to register his/her objection during the discussion of this point. Moreover, all were agree to the president of commission proposal ([see attachment](#)).

10) Award A Grade

The point was postponed to next RC meeting ([statistics see attachment](#)).

11) Miscellaneous

- At times RC have been shared opinions in common meetings with following other FIE commissions/councils. Coaches Council, Council Women and Fencing, Rules- and Legal-Commission.
- RC intends to make next meeting 26/27 September 2015 in Moscow.

For RC
Claus Janka

Attachments:

- Masterlist 2015-16
- List OG 2016
- Summery exams 2013-15
- Proposals Congres 2015-08-03
- Statistic final bouts OG/WCH 2012-15

PROPOSALSSUBMITTED TO THE REFEREEING COMMISSION 2015 CONGRESS

MODIFICATIONS OF THE STATUTES Proposals of the Legal, Medical and PP Commissions and Women and Fencing Council

Proposal:

That the minimum representation of men and women on the FIE Executive Committee and all FIE Commissions and Councils should be raised from 20% to 30%.

Rationale:

In 2007 the Olympic Charter was amended to include, for the first time in history, the following:

"The IOC encourages and supports the promotion of women in sport at all levels and in all structures, with a view to implementing the principle of equality of men and women."
Rule 2, paragraph 7, Olympic Charter in force as from 07.07.2007

The International Olympic Committee (IOC) has publically committed itself to increasing the number of women occupying leadership positions within the Olympic Movement. Twelve years ago, in 2003, the FIE Congress took the decision to require minimum representation of 20% of men and women on the FIE Executive Committee and all FIE Commission.

In line with the commitment of the IOC and best practice in organisational governance, it is now time to increase gender balance in the FIE by increasing the minimum representation of men and women on all FIE Commissions and Councils to 30%.

Proposed changes to FIE statutes

Proposal 1

4.3.4: In order to secure the principle of equal treatment, women and men must be represented in

overall view by at least ~~20~~-30% of the elected members of the Executive Committee. If the 15 candidates who have obtained the most votes do not include at least ~~3~~-5 persons of each gender, the Executive Committee will consist of the ~~3~~ 5 candidates for the Executive Committee who have obtained the greatest number of votes of the gender not otherwise being so represented and the ~~12~~-10 candidates of the other gender who have obtained the greatest number of votes.

If there are less than ~~3~~-5 candidates of either gender, that gender will be represented by the number of candidates put forward and the remainder of the Executive Committee will consist of the candidates of the other gender who have obtained the most votes.

RC: in favour

Proposal 2

4.4.4: If the 10 first members elected do not include ~~two~~-3 members of each gender, the Commission will consist of the first ~~8~~-7 members elected and the ~~two~~-3 members of the other gender who are candidates for the commission and who have obtained the greatest number

of votes. If no candidate of either gender has offered herself/himself as candidates, the 10 candidates of different nationalities with the greatest number of votes are elected.

RC: in favour

PROPOSALS SUBMITTED TO THE REFEREEING COMMISSION 2015 CONGRESS

MODIFICATIONS OF THE RULES

Proposals of the Executive Committee

Proposal 5

Motivation: Shorten the hours of competitions for the benefit of the athletes.

o.40

1 All the fencers qualifying from the round of pools are placed in a direct elimination table, complete or incomplete, according to the **indices resulting from the pools**. This table is fenced right through to the final.

2 **For the juniors World Cup competitions, from the last 32 the direct elimination bouts will take place on 4 pistes**, with each quarter of the table fenced on one piste.

For the cadets and juniors World Championships, from the last 32 the direct elimination bouts will take place on 8 pistes, with each quarter of the table fenced on 2 pistes.

RC: in favour (under condition that we've video at all pistes)

Proposal 12

Motivation: Reintroducing the fleche for the sabre, because it is a spectacular action and it should be allowed for this weapon, as long as it is perfectly explained to referees so that they don't equate it to another action.

t.75

5 - The **step forward**, ~~the fleche~~ and any forward movement **in which the rear foot completely passes the front foot is forbidden**. Any offence will be penalised as specified **for penalties in the 1st group (cf.t.114, t.116 and t.120)**. Any hit scored by the fencer at fault will be annulled. However, any hit correctly executed by his opponent is valid.

Application as follows: vote during the 2015 Congress and, if the change is adopted, application starting with the season 2016-2017.

RC: not in favor

Proposals of the Refereeing Commission

The Referees Commission is proposing follow modifications

Proposal 1

Material Rules:

Modification m.27.3.1 / m.32.5.4

FOIL

m.27.3.1

3. The electrical contact between the conductive jacket and the bib of the mask must be ensured by means of a white-colored or clear covered wire with two crocodile clips. The wire must be attached to the bib of the mask with one crocodile clip and to the jacket with the other. This wire must be between 30cm and 40cm long. ~~In the case of a coiled wire, the maximum length of the free cable must not exceed 25cm with a tolerance of +/- 5cm.~~ A coiled mask wire is not allowed.

RC: in favour

Proposal 2

SABRE

m.32.5.4

4. The **electrical contact** between the conductive jacket and the mask must be ensured by means of a wire and one or two crocodile clips. ~~In the case of a coiled cable, the maximum length of the free cable must not exceed 25 cm in length, with a tolerance of ± 5 cm.~~ A coiled mask wire is not allowed.

Reason:

This wire is covering at times during the match a considerable part of the valid target.

RC: in favour

Proposal 3

Technical Rules:

t.18.5. The order 'Halt!' is also given if the play of the competitors is **dangerous, confused,** or **contrary to the Rules**, if one of the competitors is **disarmed** or **steps off the piste**, or if, while retiring, he approaches too near the spectators or the Referee (cf. t.26, t.54.5 and t.73.4.j).

At foil it is forbidden, during the course of fencing, to advance the shoulder of the non-sword arm in front of the shoulder of the sword-arm (cf.t.19). Any hits scored by the fencer at fault while committing this offence will annulled.

RC: in favour

Proposal 4

t.120 cat 1: Reversing the line of the shoulders.

Reason:

- This modification would made more clear the decisions of the referee. It is mostly a "grey zone" and an igreenterpretation whether the non-sword arm is covering the valid target.
- If the fencer is turning in the non-sword shoulder so in same time is not more visibly by the camera what he is doing with his non-sword hand.

RC: in favour

Deferred Proposals

1. Deferred proposal of the Hungarian Fencing Federation

Motivation:

It is merely a clarification of an existing rule, more precisely that the fencer must not be penalised by one meter unless he crosses the lateral boundaries of the piste with two feet.

t. 17.9

The return on guard, at a distance, for a **lateral exit of the two feet** may place the opponent committing the error on the other side of the rear line and lead to a hit.

Opinion of the working group 2015 (Rules, Refereeing, Promotion Commissions, Coaches Council, Athletes Commission) in charge of reviewing the proposal deferred in 2014:

The text proposed by the Rules Commission in English is preferable, but the English text will have to be adapted for application in French. The new French text proposed is the following:

If a fencer crosses the lateral boundaries of the piste, with one or two feet, he must be placed on guard at the correct distance, even if this means that he is placed behind the rear line and causes a hit to be awarded against him. (cf t.28, t.102).

RC: is not necessary because current rules are clear

2. Deferred proposal of the Russian Fencing Federation

Motivation:

Reducing the number of simultaneous attacks for sabre. Increasing the number of actions in order to make matches more spectacular.

t.17.

1. For foil and épée, ~~The~~ **Referee places** each of the two competitors in such a way that the front foot of each is 2 metres from the centre line of the piste (that is, behind the 'on-guard' lines).

2. For sabre, the referee places each of the two competitors in such a way that the back foot of each is 2 m from the centre line of the piste (that is, in front of the "on-guard" lines).

RC: not in favour

Opinion of the working group 2015 (Rules, Refereeing, Promotion Commissions, Coaches Council, Athletes Commission) in charge of reviewing the proposal deferred in 2014:

The object of this proposal is to reduce simultaneous attacks at sabre. An ad hoc commission must be nominated by the Executive Committee as soon as possible, with the task to obtain statistics regarding simultaneous attacks during the rest of the 2015-16 season.

The working group is in favour of the proposal to organise tests, by introducing the rules proposed by the Russian Federation as temporary rules for all categories at sabre, men and women, during the period from the start of the 2016-2017 season until 31 December 2016.

The ad hoc commission will study the tests through comparisons with the statistics from the previous season. It will deliver its opinion at the end of 2016 to the Executive Committee, which will decide if the rule will be applied for the rest of the 2016-17 season.

The correct numbering of the articles in the proposal is t.17.2.a and t.17.2.b

3. Deferred proposal of the Swedish Fencing Federation

Adjustment of calculation procedure for individual and teams world ranking during the year following the Olympic Games (o.83 and o.84)

Motivation:

Participation in the Olympic Games is very limited. However, the multiplying factor for points attributed during the Olympic Games is of 3 for the individual competition and 2 for the teams competition (World Cup: 1; Grand Prix: 1.5; and World Championships: 2). This leads to an imbalance in the world rankings during the year following the Olympic Games, which is not corrected prior to the next World Championship, which can have even more lasting consequences on the ranking.

Opinion of the working group 2015 (Rules, Refereeing, Promotion Commissions, Coaches Council, Athletes Commission) in charge of reviewing the proposal deferred in 2014:

The working group recognises that there is a problem with the official FIE rankings during the season following the Olympic Games. In particular, in all Olympic teams competition participation is very low, which gives too much protection to participating teams and causes immobility in the rankings during the season following the Games.

The intention of the proposal formulated by the Swedish Federation to find a solution to this problem has also been mentioned by the Athletes Commission. However, the Athletes Council and the working group do not consider it appropriate to entirely cancel the results of the Games in the rankings of the new season.

The working group proposes that the multipliers be adjusted in order to reduce the consequences of the limited participation to the Games, and to improve the initial rankings of the competitions during the new season following the Olympic Games. The opinion of the working group is that the following multipliers are suitable:

The group proposes the following text in the Rules:

o.83.2 Individual ranking

b) The different competitions are attributed the following multipliers

Competition	Individual competitions
Olympic Games	2
World Championships	2
Grand Prix	1.5
Zonal Championships	1
World Cup	1

~~b) Points obtained in an individual A Grade World Cup competition have a multiplying factor of 1.~~

~~c) Points obtained in a Grand Prix competition of the FIE and a Zonal Championship are multiplied by a factor of 1.5.~~

~~d) Points obtained in the individual events of the Senior World Championships and in the Junior World Championships are multiplied by a factor of 2.5.~~

~~c) e) Points obtained in the individual events of the Olympic Games are multiplied by a factor of 3.0.~~ At the **Olympic Games**, the 4th is awarded ~~54~~ **36** points.

d) ~~f)~~ Only fencers who have **actually participated** in a direct elimination table can receive any points.

RC: not in favour

4. Deferred proposal of the Swedish Fencing Federation

o.84.2 Team scale of points

b) The different competitions are attributed the following multipliers

Competition	Multiplier
Olympic Games	1.5
World Championships	1.5
Zonal Championships	1
World Cup	1

~~b) For the World Team Championships, the points indicated above are multiplied by two.~~

~~c) Points obtained in a Zonal Team Championship have a factor of 1.0.~~

RC: not in favour

5. Deferred proposal of the Swedish Fencing Federation

Creating a cycle for the Olympic programme, based on the principle of gender equality and equality between the different weapons (o.48.1)

Motivation:

The situation in which there are ten gold medals attributed to fencing at the Olympic Games continues since 2004, and there is no sign that the number of medals will increase. To this day, the Congress has taken decisions in what regards the Olympic programme three years in advance (for example, in November 2013 for the Olympic Games in Rio in 2016). It is clearly too late to allow athletes and national federations to prepare and plan their activities in a structured manner.

Consequently, it is desirable to clearly establish in our rules the Olympic programme cycle, in order to ensure stability and equity between the genders and the different weapons.

The Swedish Fencing Federation proposes the continuation of the cycle applied for the Olympic Games in Beijing, London, and Rio de Janeiro.

Opinion of the working group 2015 (Rules, Refereeing, Promotion Commissions, Coaches Council, Athletes Commission) in charge of reviewing the proposal deferred in 2014:

The working group is in favour of the proposal, but there seems to have been a misunderstanding concerning the structure of the proposed cycle. This proposal provides balance between the weapons and the genders in the current situation, even if it is very important to obtain two additional medals. The working group proposes the following cycle:

Programme of competitions

o.48

1. The programme of fencing events at the **Olympic Games** currently comprises 10 events. Given that the situation does not allow for organising 12 events, the programme of team events at the Olympic Games varies so that two weapons per team are not included during each Olympic year. For events not included in the Olympic programme, the FIE will organise World Championships.

The team competitions cycle at the Olympic Games will be:

Olympic Games 2016: Men's foil, men's épée, women's épée, women's sabre. (In the case of women's foil and men's sabre, the FIE will organise World Championships.)

Olympic Games 2020: Women's foil, men's épée, women's sabre, men's sabre. (In the case of men's foil and women's épée, the FIE will organise World Championships.)

Olympic Games 2024: Women's foil, men's foil, women's épée, men's sabre. (In the case of women's sabre and men's épée, the FIE will organise World Championships.)

The cycle described above is continued for the following Olympic Games (2028, 2032, ...)

Any change to the above cycle or to the number of events must be approved by the Congress.

RC: in favour



Exams	date	place	candidates			candidates			candidates			candidates total	successful total	successful %	new B licenses	examiners
			foil	P	B	epee	P	B	saber	P	B					
	14/16-8-2013	San Jose/GUA	18	6	4	23	7	11	16	5	6	57	39	68		Alvarez/Ferjani
	13/15-11-2013	Bratislava/SVQ	18	3	11	27	7	18	17	4	9	62	52	84		Dakova/Siesto
	25/27-2-2014	Jerusalem/ISR	22	6	11	23	9	11	15	4	6	60	47	78		Gutsait/Knysch
	4/6-3-2014	Amman/JOR	26	11	4	23	10	3	15	6	2	64	36	56		EIMotawakel/Ferjani
	17/19-6-2014	Cairo/EGY	9	7	2	10	1	8	8	0	6	27	24	89		Knysch/Janka
	5/8-11-14	San Salvador/ESA	13	6	5	16	8	6	10	3	5	39	33	85		Knysch/Alvarez
	21/23-2-15	Maribor/SLO	19	10	8	18	10	3	15	7	6	52	44	85		Knysch/Ferjani
	25/27-2-15	Abu Dhabi/UAE	18	5	10	17	2	12	17	5	10	52	44	85		EIMotawakel/Mamedov
	14/16-4-15	Cartagena/CHI	10	6	2	11	4	5	6	3	2	27	22	81		Knysch/Alvarez
	8/10 6-15	Cairo/EGY	9	1	6	11	2	7	8	3	5	28	24	86		Dakova/Ferjani
	27/28-6-15	San Jose /USA	11	0	6	0	0	0	8	0	7	19	13	68		Knysch/Siesto
			173		69	179		84			64	487	378	78	217	
P-observation	16/17-11-2013	Bratislava/SVQ	3		3	7		7	0		0	10	10	100		Dakova/Siesto
	4/5-1-2014	Udine/ITA	1		1	1		1	2		2	4	4	100		Ferjani/Siesto
	4/6-2-2014	GuatemalaCity/GUA	9		9	9		9	4		4	22	22	100		Dakova/Alvarez
	28-2/2-3-2014	Jerusalem/ISR	6		4	9		6	5		3	20	13	65		Gutsait/Knysch
	7/16-3-2014	Amman/JOR	18		16	19		19	11		11	48	46	96		EIMotawakel/Ferjani
	08.11.2014	San Salvador/ESA	0			6		4	0		0	6	4	66		Knysch/Alvarez
	24/26.2.15	Maribor/SLO	10		6	13		13	7		7	30	26	87		Knysch/Ferjani
	1/3-3-15	Abu Dhabi/UAE	8		7	8		7	7		6	23	20	87		EIMotawakel/Mamedov
			55			72			36			110	99		94	

311

Remarks: *incones FIE examens fee (~ 60 €)*
expenses exams resp P-observations in Jerusalem, Amman, Guatemala City, Abu Dhabi Cartagena were connected witch the Continental Jun/Sen Champs. Host contry have taken the expenses for one deleguae
Finally the exams was made with a less financial expenditure for FIE.

Elite referee 2014-15

bouts

RC 1 Aug 2015 Bucarest

weapon		OG London 2012				WCH Budapest 2013				WCH Kazan 2014				WCH Moscow 2015				DF	F
		Individ		team		Individ		team		Individ		team		Individ		team			
		DF	F	3	F	DF	F	3	F	DF	F	3	F	DF	F	3	F		
Foil																			
Gheorge, Florin	ROU									1		1	1	1			2	2	4
Ferjani, Ayoub	TUN	1	1	2		1	1	1	1		1	1						6	4
Vogel, Bodo	GER			1	1		1	1	1			1					1	3	5
Pistacci, Marco	ITA								1			1		1	1			2	2
Zuravleva, Natalia	RUS								1		1					1		1	1
Lorenzo, Javier	ESP					1		2		1		1		2				7	0
Suh, Sangwon	KOR			1			1									1		0	3
Findley, Douglas	USA	2														2		4	0
Lyberopoulos, Constar	GRE	1	1			1	1	1	1		1			finished				4	3
Humbert, Lionel	FRA A		1															0	1
Guenet, Jean-Marc	FRA A								1									1	0
ElAraby, Tamer	EGY A	1		2														3	0
Mage, Pascal	FRA					1												1	0
Madr, Vilem	CZE							1				1		1				3	0
Wittkowsi, Andre	POL											1		2				3	0
Machado, Miguel	POR											1						1	0
Nagimov, Rail	RUS								1									1	0
Epee																			
Trois d'Avila, Regis	BRA A	1	1	1	1	1	1				2			1				2	5
Ranza, Giuliano	ITA A												1				1	0	2
Fallah, Alaa	IRQ					1	1		1		1			1		1		3	3
Rios Rivera, Juan	MEX		1	1	2		1		1			1	1			1		5	4
Paghiev, Michal	MDA			1		1			1					1		1		5	0
Piatko, Andre	FRA A													1				1	0
Leitner, Barbara	AUT																	0	0
Liendo, Juan	VEN A					1		1		1		1		1			1	5	1
Lu, Jiangmin	CHN		1															0	1
Leong, Denis	SIN		2	1										1	1			2	2
Haynes, Matthew	GBR	1		1		1												1	2
Ivanov, Alexander	ISR					1	1			1		1						1	3
Genser, Martina	AUT					1												0	1
Wong, Kam Kau	HKG							1										0	1
Turiace, Sergio	ARG						1											1	0
Deli, Dra	HUN							1										0	1
Leitner, Barbara	AUT	1							1									2	0
Feoktistov, Valerian	RUS								1								1	2	0
Sachwadse, David	GEO															1		1	0
Saber																			
Florea, Marius	ROU A	1				1		1	1		1			1				3	3
Milentchev, Vasil	BUL	1	1	1		1	1	1	1	1				1	1		2	6	6
Toure, Papakassam	SEN		2			1	1			1	1			2		1	1	5	4
Shamis, Vladislav	RUS										2							0	2
Kaposvary, Zsolt	HUN A	1		1		1	1	2		1		1						3	4
Martilotti, Luigi	ITA					1		2						2		1		4	1
Becker, Willam	USA					1						1						1	1
Jiang, Yefei	CHN											1						1	0
Snayder, Rafal	POL	1				1												2	0
Lahotska, Maxim	BLR		1															0	1
Zheng, Zhao	HKG	1										1						2	0
Fakhry, Peyman	IRN					1				1		1		1			1	4	1
EL Bakry, Medhad	EGY									2						2		4	0

Elite referee 2014-15

bouts

RC 1 Aug 2015 Bucarest

weapon		OG London 2012				WCH Budapest 2013				WCH Kazan 2014				WCH Moscow 2015			
		Individ		team		Individ		team		Individ		team		Individ		team	
		DF	F	3	F	DF	F	3	F	DF	F	3	F	DF	F	3	F
Foil																	
Gheorge, Florin	ROU										MF		MF	WF	MF		WF
Ferjani, Ayoub	TUN	WF (V)	MF	WF		WF	WF		MF	MF (V)		MF	WF				MF
Vogel, Bodo	GER			ME	WF			MF	WF	MF (V)			WF				MF
Pistacci, Marco	ITA									WF (V)			MF		WF	MF	
Zuravleva, Natalia	RUS										WF						WF
Lorenzo, Javier	ESP					MF		WF		WF (V)		ME		WF (V)			
Suh, Sangwon	KOR				MF		WF										WF
Findley, Douglas	USA	WF															WF
Lyberopoulos, Constanzi	GRE	MF	WF (V)			WF (V)	MF (V)		MF	WF (V)		MF		finished			MF
Humbert, Lionel	FRA		WF														
Guenet, Jean-Marc	FRA									WF							
ElAraby, Tamer	EGY	WF			WF												
Mage, Pascal	FRA					WF											
Madr, Vilem	CZE							WE				WF		MF			
Wittkowski, Andre	POL											WF		WF			
Machado, Miguel	POR												WE				
Nagimov, Rail	RUS									WE							
Epee																	
Trois d'Avila, Regis	BRA	ME	WE (V)		WE	ME (V)	ME					ME			ME		
Ranza, Giuliano	ITA													WE			ME
Fallah, Alaa	IRQ					ME	WE			ME		ME			ME (V)		ME
Rios Rivera, Juan	MEX		WF (V)		WF	ME		WF		WE (V)			ME	ME			WE
Paghiev, Michal	MDA				WE							ME (V)			ME		ME
Piatko, Andre	FRA													WE			
Leitner, Barbara	AUT																
Liendo, Juan	VEN					WE		ME		ME (V)		WE		WE (V)			WE
Lu, Jiangmin	CHN		ME														
Leong, Denis	SIN		WE												WE	WE	
			ME (V)	WE													
Haynes, Matthew	GBR	WE			WE		WE										
Ivanov, Alexander	ISR						ME	WE			WE		ME				
Genser, Martina	AUT						WE (V)										
Wong, Kam Kau	HKG								ME								
Turiace, Sergio	ARG							ME									
Deli, Dra	HUN								WE								
Leitner, Barbara	AUT	WE								WE							
Feoktistov, Valerian	RUS									WE (V)							ME
Sachwadse, David	GEO																WE
Saber																	
Florea, Marius	ROU	WS				WS		MS	WS		WS				WS		
Milentchev, Vasil	BUL	MS	WS	MS		MS	WS (V)	WS	MS	WS (V)	WS			WS	MS		WS
Toure, Papakassam	SEN		MS			WS	MS			WS (V)	MS			WS (V)		MS	WS
			WS (V)											MS (V)			
Shamis, Vladislav	RUS										WS						
											MS						
Kaposvary, Zsolt	HUN	WS			MS		WS	MS			MS (V)		MS				
Martilotti, Luigi	ITA					MS				MS				WS		WS	
										WS				MS			
Becker, Willam	USA						MS (V)					MS					
Jiang, Yefei	CHN											WS					
Snayder, Rafal	POL	WS				MS (V)											
Lahotska, Maxim	BLR		MS (V)														
Zheng, Zhao	HKG	MS										WS					
Fakhry, Peyman	IRN					MS (V)				MS (V)	MS		MS				MS
EL Bakry, Medhad	EGY									WS							WS
										MS							WS

Foil		RC		SF		IK		ID		IM		SF		CJ		WC-WF Cancun 16 / 18-10-2015 WC-WF San Jose 16 / 18-10-2015 WC-WF SL Maur 6 / 8-11-2015 WC-WF Tokyo 6 / 8-11-2015 GP-WF Turin 27 / 28 -11-2015 GP-WF Turin 27 / 29 -11-2015 WC-WF Gdansk, 15 / 17-1-2016 WC-WF Paris 15 / 17-1-2016 WC-WF Alger 5 / 7-2-2016 WC-WF Bonn 5 / 7-2-2016 GP-WF Havana 11 / 12 -3-2016 GP-WF Havana 11 / 13 -3-2016 WC-WF SPetersbg 13 / 15 -5-2016 WC-WF TBB 2 / 22 -5-2016 GP-WF Shangai 3 / 4 -6-2016 GP-WF Shangai 3 / 5 -6-2016 total AF Games Brazzaville, 2 / 6 -9-2015 WCH-Vet Limoges 20 / 25 -10-2015 WCH JC Bourges, 1 / 9 -4-2016 Ou-OG-AS, China, 11 / 12 -4-2016 CH-AS China, 13 / 18 -4-2016 Ou-OG-AF, n.n., 15 / 17 -4-2016 CH-AF, n.n., 10 / 15 -4-2016 Ou-OG-PAM, San Jose/CRC, 15 / 17 -4-2016 Ou-OG-EU, Prag, 15 / 17 -4-2016 CH EU JC Novi Sad, 29 / 9 - 3-2016 CH PAM J/C Puerto Vallarta, Febr ? 2016 CH AS J/C n.n. CH AF J/C n.n. CH-PAM, End of June, Dallas/Atlanta CH-EU Torun, 20 / 25 -6-2016 WCH n.n. OG Rio, 6 / 14 -8-2016																										
EU	Madr	Vilem	CZE	B	B	1							1			2																										
22	Hejrovskov	Mads	DAN	B	B	R		R								0																										
	Lorenzo	Javier	ESP	B	B	B	1	1		1						3																										
	Wiar	Renault	FRA	B												0																										
	Guenet	Jean-Marc	FRA	A	B		1									1																										
	Mage	Pascal	FRA	B	B					1						1																										
	Böcker	Jens	GER	B	B											0																										
	Vogel	Bodo	GER	B	B	B	1			1						2																										
	Denzer	Benjamin	GER	B	B	B			1							1																										
	Gatei	Robert	HUN	B	B			R			R					0																										
	Pistacchi	Marco	ITA	B	B	B	1	1								2																										
	Pierucci	Guiseppe	ITA	B	B					1						1																										
	Scomparin	Isacco	ITA	B		B	1									1																										
	Paghiev	Mihail	MDA	B	B	B					1					1																										
	Cojociari	Olga	MDA	B	B		R		1							1																										
	Kielplikowski	Pjotr	POL	B	B					R						0																										
	Wittkovski	Andrzej	POL	B	B			1				1				2																										
	Machado	Miguel	POR	B	B			1				R				1																										
	Gheorge	Florin	ROU	B	B	B	1		1	1						3																										
	Zurawlowa	Natalia	RUS	B	B		1			1	1					3																										
	Rouzavina	Ianna	RUS	B	B				1							1																										
	Nagimov	Rail	RUS	B	B		R									0																										
AS	Lu	Jianming	CHN	B	B					1						1																										
7	Zheng	Xiao lan	CHN	B												0																										
	Wu	Han Xiong	CHN	B	P	B						1				1																										
	Wong	Kam Kau	HKG	B	B					1	R					1																										
	Go	Jong	KOR	B	B				R							0																										
	Suh	Sangwon	KOR	B	B		1			1	1					3																										
	Huang	Hao Chi	TPE	B	B	B				1						1																										
	Alshamli	Rashed	KOW	B	B	B	1	1			1					3																										
AM	Kuznetzow	Alexej	CAN	B	B		1			R	1					2																										
7	Nguyen	Thomas	CAN	B	B	B	1									1																										
	Rios	Juan	MEX	B	B	B			R		1					1																										
	Badawi	Amgard	USA	B	B											0																										
	Johnson	Kelly	USA	B	B		1			1	R					2																										
	Findley	Douglas	USA	B		B					1					1																										
	Cordero	Darwin	VEN	B	B											0																										
AF	El Naggat	Bassel	EGY	B	B	B	1		1		1					3																										
2	Sherif	Ali	EGY	B	B	B																																				
							8	8	8	8	14	0	0	0	0	0	0	0	0	0	0	0	0	0	0	0	0	0	0	0												

SF=S.Ferjani, MS=M.Siesto, IM.=I.Mamedov, CJ=C.Janka, VG=V.Gutsait, ID.=I.Dakova, IK=I.Knysch, LA=L.Alvarez, CK=C.Kim, ME=M.EiMotawakel elite

Elite 2015-16

Gheorge, Florin	ROU	Trois d'Avila, Regis	BRA	Milentchev, Vasil	BUL
Vogel, Bodo	GER	Rios Rivera, Juan	MEX	Toure, Papakassam	SEN
Zurawlowa, Nathalia	RUS	Liendo, Juan	VEN	Shamis, Vladislav	RUS
Pistacci, Marco	ITA	Paghiev, Michal	MDA	Florea, Marius	ROU
Findley, Douglas	USA	Fallah, Alla	IRQ	Martilotti, Luigi	ITA
Lorenzo, Javier	ESP	Ranza, Giuliano	ITA	Jiang, Jefe	CHN
Alshamali, Rashed	KUW	Sachwadse, David	GEO	Fakhry, Peyman	IRI
Suh, Sangwon	KOR	Leong, Denis	SIN	El Bakry, Medhat	EGY

Delegates RC Rio Test event resp WCH teams:

L.Alvares, I.Knysch, S.Ferjani, C.Janka



Legal Commission Meeting

July 30 and 31st, August 1st, 2015

Bucharest (ROM)

Report

1. Urgent proposals from the COMEX and Medical Commission, plus the increase in percentage of women on bodies of the FIE were discussed and voted upon – results of such discussion are found in the revised Proposals document
2. Review and recommendations regarding the statutes of the Confederations – The required and suggested revisions for the Confederation statutes were discussed among the members of the Commission assigned to each of the Confederation teams.
3. Establishment of Rules for Betting – The ASOIF document was reviewed and amended are made an exhibit to the Ethics Code. See attached document.
4. Proposal regarding Candidacies for championships was reviewed and revised. The proposal adopted by the Legal Commission is found in the revised Proposals document.
5. Review and recommendation regarding the Ethics Code – The draft Ethics Code was reviewed and amended – See attached document.
6. Review and recommendations on proposals in the draft report on Good Governance – The proposals were reviewed and made a part of the revised Proposals document
7. Proposal for the establishment of a Fair Play Council – This was approved and is part of the Proposals document.
8. Asoif data project – This was reviewed by the Commission and a separate letter was sent to the FIE outlining the issues of concern to the commission.

**PROPOSALS SUBMITTED TO THE LEGAL COMMISSION
2015 CONGRESS**

**MODIFICATIONS OF THE STATUTES
Proposals of the Executive Committee**

Proposal 1

Motivation: Update the article according to practice established several years ago: it is the organizer that receives the entry fee for the World Championships

1.6 FINANCIAL RESOURCES – In Favor 6-0

The financial resources of the F.I.E. consist of:

- 1) Federations' subscriptions
- 2) Licence fees
- ~~3) Entry fees for the World Championships~~
- 4 3) Fees for the organisation of competitions
- ~~6 4) Television rights~~
- ~~6 5) Donations and income from its sponsorship contracts~~
- ~~7 6) Such other resources as may be developed~~

The amounts of the fees above (items 1 to 4) are determined by the Executive Committee and approved by the Congress for the following season.

Proposal 2 – In Favor 6-0 as modified

Motivation: The Executive Committee, according to the FIE Administrative Rules and article 1.6 of the FIE statutes, suggests the following new amount for 2015/2016 seasons:

6.1 Amount to be paid to the FIE:

Subjet	Euros	Deadline
Organizing fee junior team A tournament	300 250	Before the 1 st day of the competition

Proposal 3 – In Favor 6-0

Motivation: The current entry fee is too low and has not changed for years, although the costs of the organizers have been increasing.

6.2 Amounts to be paid to the organizers:

Subjet	Euros
Entry fee junior A grade tournament	15 25

Proposal 4

Motivation: Any competition organization should be subject to payment of an entry fee. It is not normal that an organizer perceives nothing in return for hosting a competition.

6.2 Amounts to be paid to the organizers: - In Favor 5-1 as modified

Subjet	Euros
Entry fee junior team tournament	400 150

Proposal 5 – In Favor 6-0

Motivation: Align the text on this Commission to the text of all the other commissions, as adopted by Congress in 2014.

6.5.2 The Rules Commission

a) The Rules Commission presents a report [to the Executive Committee which will be submitted to the](#) Congress on any proposal concerning the organisation and running of competitions, equipment and material (in co-operation with the SEMI Commission), the way to fence an opponent, the rules for fighting a bout, behaviour on and around the piste, and the penalties relating to these proposals.

Proposal 6 – In Favor 6-0

Motivation: Aligning the Athletes Commission at meetings organized by the FIE on other Commissions.

6.4.4 For the Athletes Commission, [which is meeting in accordance with Articles 6.2.4 and 6.4.1](#) ~~the member federation of each member will be responsible for the costs of transportation and lodging necessary for the athlete to take part in the meetings of the commission,~~ the FIE financial support is the same as for the other commissions and on the same conditions.

Proposals of the Legal Commission

Proposal 1 – In Favor 6-0

FAIR PLAY COUNCIL

Aim:

Create a Fair Play Council

Motive:

- §□ The concept of Fair Play is noted in several chapters of the I.O.C Charter.
- §□ The majority of Olympic sports have an Ethics or Fair Play Commission or Council
- §□ The new I.O.C. Education Department has asked International Federations to stress the spirit of fair play in training and in the battle against doping. The F.I.E. should pursue this I.O.C. programme.

Modify Articles as follows:

4.7.8 For each of the Veterans, ~~and~~ Women and Fencing ~~and~~ Fair Play Councils, to the extent that there are sufficient candidates the selections should include at least one representative from each of the five continents.

Chapter 6 A – the Councils

6 A. 1.1. Councils

add: - Fair Play Council

6 A. 2.1. Structure

6A.2.1 Each Council is made up of ten voting members selected by the Executive Committee, ~~except the Fair Play Council, which shall consists of seven members selected by the Executive Committee.~~

6 A. 5.4. Fair Play Council

The Fair Play Council performs the following functions:-

- It concerns itself with all questions, announcements and proposals in the realm of fair play.
- It contributes to the creation of interactive programmes at the World Championships and major international competitions of the F.I.E.
- It brings to the attention of the Executive Committee any truly exceptional cases of fair play, including those that it proposes that the Executive Committee report to the Fair Play Committee of the I.O.C.

Proposal 2 - In Favor 6-0

FIE - GOOD GOVERNANCE – PROPOSED REGULATORY CHANGES

1. Amendment of Statutes 1.1

"The aims of the F.I.E. are:

- l) to ensure fair sporting contests so that the spirit of fair play prevails.
- m) to establish rules and appropriate measures to protect the health of athletes and prevent any abuse.
- n) to take appropriate means to provide for the social and professional future of athletes.

Proposal 3 – In Favor as modified – 6-0

2. Amendment of Statutes, 1.2.8

The F.I.E. and its bodies shall observe open tenders for their marketing, media and procurement contracts.

Proposal 4 – In Favor 6-0

3. Amendment of Statutes 3.2.1:

"The Congress appoints professional auditors as auditors for the following fiscal year, which can be renewed. The report of the auditors shall be based on recognized international financial reporting standards."

Proposal 5 – In Favor 6-0

4. Amendment of Statutes 5.5.1:

"The Executive Committee ensures the management of the F.I.E. between congresses in accordance with the Statutes and takes the most suitable measures for the development of fencing world wide. Management of the F.I.E. is based on principles of accountability, compliance and good governance. Appropriate measures to identify and minimize potential risks shall be adopted."

Proposal 6 – As modified In Favor 6-0

5. Amendment of Statutes 5.6.1:

"5.6.1

The President is the legal representative of the International Fencing Federation. If he is unable to attend any meetings or events, he is replaced by the Secretary General.

Mis en forme : Police : (Par défaut) Arial, Couleur de police : Texte 1, Non Barré

Proposal 7 – In Favor 6-0

6. Amendment of Statutes 5.8.1:

"g) The Treasurer is responsible for drafting the financial report according to Article 3.2.1. It shall include separate statements concerning travel expenses and allowances granted to the President and the members of the Executive Committee."

Proposal 8 – As modified – In Favor 6-0

7. Amendment of Statutes, 10.1

10.1.3. Member federations who organize official FIE competitions shall observe open tenders for their marketing, media and procurement contracts relating to these events.

Proposal 9 – In Favor 6-0

8. Amendment of Statutes 10.2.1 lit. b:

"When it puts forward its candidature, a federation must present a full dossier which complies with the FIE instructions, and make a commitment before the Congress to comply with the specifications set down by the FIE and to respect its financial obligations as well as the environment and the principle of sustainable development."

Proposal 10 – Proposal Withdrawn

Motivation:

Mis en forme : Barré

~~To permit, in very exceptional circumstances, a fencer who has changed nationality to revert to his previous nationality.~~

9.2 FENCERS' NATIONALITY

9.2.1

~~At the Olympic Games a competitor's nationality is set by rules of the I.O.C. to which the F.I.E. must conform.~~

9.2.2

~~For official competitions of the F.I.E., competitors must be strictly of the nationality of the country which they are representing:~~

~~a) The fencer who enjoys multiple nationality must choose which country he wishes to represent. The fact that he has fenced for one of the countries implies that he has made a choice. If he wishes to represent another country of which he enjoys nationality, he must so advise the Office of the F.I.E. and he may only represent this other country after an interval of three years from when he advised the Central Office of the F.I.E., during which he can no longer represent the other country.~~

~~b) A fencer who has already represented a country and acquires a new nationality (from being stateless or through naturalisation) can only represent his new country after an interval of three years from his last participation in a competition for his previous country.~~

~~c) The fencer who acquires a new nationality as a result of marriage may fence for that new country immediately, without waiting three years.~~

~~d) The Executive Committee of the F.I.E., with the agreement of the member federations concerned, and only for just reasons, may reduce or dispense with the interval of three years.~~

~~e) The fencer who has never participated in an official competition of the F.I.E. or in a Regional Championships, is not constrained by these limitations concerning change of nationality and may fence for his new country immediately.~~

~~f) Only in very exceptional circumstances can a fencer make a further (second) change of nationality and the conditions of such a change are defined in article 9.2.3 below. Otherwise aAny change in country which a fencer represents is definitive; no further change can be authorised.~~

~~g) In cases of dispute the Executive Committee of the F.I.E. will make a ruling, which is not subject to appeal.~~

~~9.2.3~~

~~a) A second change of nationality, and only to the nationality which he first represented, can only be authorized if a fencer is deprived of or forced to resign the nationality to which he had changed pursuant to article 9.2.2 a).~~

~~b) A request for such a change of nationality can only be approved by vote by the Executive Committee of the F.I.E. at one of its meetings after full discussion of an analysis of the authenticity of and justification for the request prepared by the president of the Legal Commission and the CEO.~~

~~c) A fencer can only represent his new country after an interval of three years from his last participation in a competition for his previous country.~~

~~d) The Executive Committee of the F.I.E., with the agreement of the member federation(s) concerned, and only for just reasons, may reduce or dispense with the interval of three years, but not so as to permit the fencer concerned to represent his new country for the first time in the eighteen months preceding the opening of the Olympic Games.~~

~~9.2.3 9.2.4~~

~~For the FIE competitions fencers who are legally stateless may compete as long as they are registered by the member federation of the country in which they live.~~

~~The practical process for a request of modification of nationality is stated in the FIE Administrative Rules, "Licences and nationality" chapter.~~

Mis en forme : Barré

Mis en forme : Barré

Proposal 11 – As modified – In Favor 6-0

STATUTES ARTICLE 10.2.1

Motivation: To specify in more detail the process for assigning the organisation of (World Championships) (all categories).

Proposal: Modify Article 10.2.1 as follows:-

10.2.1 *Candidatures for a World Championship*

a) ~~Each year, requests to undertake the organisation of the World Championships for the following years, accompanied by a file describing the technical and financial circumstances of~~

~~the candidature, must reach the head office of the F.I.E. three years before the organising of the competition. These requests are to be placed on the agenda of the Congress and must arrive within the time limit laid down by the F.I.E. Statutes for inclusion thereon.~~

Each year, requests to place on the agenda of the forthcoming Congress Completed Candidatures (as defined below) to undertake, in the third calendar year ahead, the organisation of the senior World Championships, the junior/cadet World Championships and the veteran World Championships must reach the head office of the F.I.E, within the time limit laid down , one month before the 3rd meeting of the Executive Committee of that year.

b) When it puts forward its candidature, a federation must present a full dossier which complies with the FIE instructions, and make a commitment before the Congress to comply with the specifications set down by the FIE and to respect its financial obligations ("Completed Candidatures"). A candidature submitted without a full dossier shall not be considered as a Completed Candidature and will not be considered as a candidate for a Championship.

c) Should one or more candidates be listed on the agenda of the Congress, the awarding of the organising of these championships will take place at that Congress.

d) Should the Congress not accept this candidate or should no candidates have come forward at this point, the FIE Central Office will actively seek (a) candidate(s) to be presented at the following Congress pursuant to procedures to be outlined in the Administrative Rules.

~~d) The congress will decide two years in advance to which member federations the organisation of the Championships will be entrusted, and, at the same time, fix the date and place where they will be held.~~

e) e) When the Congress has awarded the World Championships to a Member Federation, the President of the organising Federation and, if the case arises, the organiser himself shall sign a protocol detailing their complete awareness of the specifications set down by the FIE and of their financial obligations.

f) ~~e~~) Should the Ordinary Congress **two years before the year of the event** be unable to decide by the above process which member federation will organise the World Championships, because no **Completed Candidatures have been presented** ~~candidate has come forward~~, the ~~Central-Office~~ **Executive Committee** of the F.I.E. may itself decide which member federation will organise these Championships if it receives one or more **candidates completed candidatures** after the Congress has taken place **pursuant to procedures to be outlined in the Administrative Rules**.

g) ~~f~~) The Executive Committee of the F.I.E. will have the same powers should the member federation to whom the organisation was entrusted by the Congress withdraw **and or** in the event of any discriminatory act by the organising federation.

~~g) Furthermore, the Congress will accept the candidatures proposing to organise separate Junior and Cadet Championships.~~

~~h) Requests to undertake the organisation of the Veteran World Championships for the following years, must reach the head office of the F.I.E two years before the organising of the competition.~~

Proposal 12 – As modified (see separate file) In Favor 6-0

F.I.E. ETHICAL CODE / F.I.E. CODE OF ETHICS

Mis en forme : Non Barré

1.-INTRODUCTION

The FIE Ethics Code is based on the IOC Code of Ethics and aims to preserve the ethical values and principles that inspire the Olympic Charter and which must inspire, in any case, the performance of the members of the International Community of Fencing understood in the broadest manner (hereinafter, also referred to as or "FIE Family").

The FIE Ethics Code ("Code") defines the principles of conduct that should regulate sports and administrative activities of the entity and the FIE Family. The Code aims to promote and safeguard the ideals of dignity, integrity, cooperation, sportsmanship and fair competition, which should characterize the performance of all components of the FIE Family.

The FIE Community includes: directors, officers and members of the FIE, the Member Federations and Confederations recognized by the FIE and their managers, the members of the Organizing Committees of official competitions and the representatives of the candidate cities for the organization of official competitions as well as fencers, coaches, referees, other members of national delegations participating in any competition or event developed under the umbrella of the FIE, and as applicable, employees, partners and service providers directly or indirectly linked to the FIE.

2. ETHICAL FUNDAMENTALS, PRINCIPLES AND RULES

The FIE Family is obliged to respect and ensure respect for the following principles and rules, particularly with regard to the organization and development any official competition, event or activity recognized by the FIE.

I.- Dignity:

1. It must safeguard the dignity of any person as a fundamental requirement of Olympism and the FIE.
2. There should exist, in any situation, respect and consideration for the FIE Family and the general public, in order to assert the principles of legality, sportsmanship and fair competition.
3. There will be no discrimination among the FIE Family because of race, gender, religion, political or philosophical opinion, family or any other status.
4. No practice that violates the physical or mental integrity of the FIE Family will be tolerated. Any practice related to doping, at any level, is absolutely prohibited. The anti-doping rules contained in the FIE Anti-Doping Code will be scrupulously observed.
5. All forms of physical, psychological, professional or sexual harassment are prohibited.
6. Competition organizers will ensure the necessary conditions of security, welfare and medical care to promote the physical and mental balance for the FIE Family.

II.- Integrity:

1. The FIE Family must reject and denounce any form of corruption or unfair favoritism, of whatever nature, ensuring the honesty and dignity of the sport.
2. The FIE Family may not directly or indirectly, request, accept or offer any concealed remuneration, commission, benefit or service of any nature connected with the organisation of official Championships, activities or events or their function as FIE officials.
Any concealed commission, compensation, benefit or service of any nature, that is received by an officer of the FIE, must be declared in writing to the FIE office within 30 days of its receipt, when its total value exceeds € 150. In case of doubt as to the value, the FIE Family member may request an opinion of the Ethics Committee.
The Ethics Committee will review the declared cases and shall decide, within 90 days, that the beneficiary of such benefits is the FIE, or that they must be returned to their source.
3. Only gifts whose total value is less than 150 €, can be given and accepted by the members of the FIE Family, as a sign of respect and friendship.
Any gift worth more than € 150 must be declared in writing to the Ethics Committee, which will decide as noted in paragraph 2.
4. The hospitality shown to members, officers and directors of the FIE Family and their companions, may not exceed normal standards. Invitations for trips offered by the organizers of competitions or events, or the Member Federations (except the one of which the officer is member), that are not based on a cooperation agreement between the organizer and the Member Federation or the FIE, must be declared to the Ethics Committee before the trip occurs. The Ethics Committee may suggest that such person decline the invitation if it is contrary to the Code.
5. The FIE Family must avoid any conflict of interest among themselves, the organization to which they belong and any other person or organization related to the Olympic movement. If a conflict of interest arises or might arise, parties shall inform the Ethics Committee of the FIE.
6. The FIE Family members shall act with the care and diligence required to perform their duties, not acting in any way to harm the reputation of fencing or the Olympic movement.
7. The FIE Family must not be complicit nor have any relationship with entities or individuals whose activity are below standard, conflicting or inconsistent with the principles of the Olympic Charter or this Code.
8. The FIE Family will never give nor accept instructions to vote or to intervene in a given or pre-established manner within the FIE bodies or organs.

III.- "Fair Play":

The concept of "fair play," beyond mere compliance with the rules and regulations, extends to the notions of loyalty, mutual respect and sportsmanship. It covers the fight against any use in the competition of unfair advantage, cunning, doping, violence (physical and verbal), inequality of opportunity or corruption.

Sport is a positive activity that enriches the individual and society provided it is practiced in an honest and honourable way, so it is the duty of all members of the FIE Family to avoid behaving in a manner contrary to fair play in the broadest sense of the concept.

IV.- Resources:

1. FIE resources may be used only for fencing and Olympic purposes.
2. Revenue and expenditures of the FIE will be recorded in accordance with recognized international financial reporting standards, and those accounts shall be audited by an independent professional auditor.
3. The FIE Family recognizes the important contribution that the media, sponsors, partners and other supporters of sporting events make for the development and prestige of the Olympic movement around the world. However, said support must be appropriate and consistent with the rules of the sport and the principles defined in the Olympic Charter and this Code. The organization and conduct of sports competitions is the sole responsibility of the FIE and the Member Federations recognized by the FIE.

V.- Candidatures:

The FIE Family members shall respect all aspects of the FIE statutes and rules adopted relating to candidate cities for the organization of official championships or competitions.

VI.- Relationships with Countries:

1. The FIE Family members will work to maintain harmonious relations with the authorities of the countries of the Member Federations, in accordance with the principles of universality and political neutrality. However, the spirit of humanism, fraternity and respect for human rights that inspires the Olympic ideal requires governments of countries of Member Federations where official competitions and other events of the FIE take place, to ensure that the principles of the Olympic Charter and this Code are scrupulously respected.
2. The FIE Family members are free to develop public functions in the countries to which they belong. However, they may not engage in any activity or follow an ideology which implicitly contradicts the principles and rules defined in the Olympic Charter or those laid down in this Code.
3. The FIE Family members undertake to protect the environment in any event organized under the auspices of the FIE, committing to maintain these activities under generally accepted environmental standards.

V.- Confidentiality:

Except as otherwise noted in this Code, The FIE Family members will keep secret any information received in confidence. Disclosure of any information must not be for personal benefit, nor be done maliciously to damage the reputation of any person or organization.

3.- RULES OF CONDUCT.-

All members of the FIE Family should always be inspired by the above binding rules and ethical principles, which lead to the following Rules of Conduct.

The Rules of Conduct generate responsibilities, rights and obligations to be assumed in the various areas of sports performance and the various levels of the organization and administration of the sport of Fencing.

THE FIE FAMILY

1. Must know, observe and apply the laws, statutes, rules and regulations governing the practice of fencing.
2. Shall concentrate the initiative and commitment of the entity in order to promote the legitimate interests of fencing within the parameters of transparency, honesty and sportsmanship, promoting and dignifying the correct practice of the sport of fencing.
3. Shall cooperate with the IOC, NOCs of the Member Federations, governments, sponsors and investors holding bonds of respect and consideration, and stressing the importance of sport for the social development, culture, education and health of its practitioners.
4. Shall strengthen and maintain relationships with all media, in order to ensure the integrity and objectivity desirable of all information related to fencing in addition to promote the sport in the public eye.
5. Shall take all necessary measures to ensure security on the premises where the competitions are held, primarily considering the physical and moral well-being of everyone involved in event.
6. Shall maintain proper conduct, avoiding engagement in actions that cause harm to their own credibility or compromise the image of the FIE and the FIE Family.
7. Shall prevent, deter and denounce (and encourage the reporting of any), use of unauthorized substances, unfair benefit, or any type of corruption in the practice of fencing.
8. Shall prohibit the FIE Family from suggesting or recommending promotion, advertising or publicity of any good or service that can harm general health, healthy habits, environment.
9. Shall prohibit and report to the Ethics Committee any kind of preferences or prejudices arising from ethnicity, colour, gender, religious belief, disability, political orientation, financial, social, or intellectual status, sexual orientation, age, marital status, among other forms of social exclusion, in any competition.
10. Shall punish acts of violence that jeopardize the physical and moral integrity of the FIE Family, media and general public, ensuring their safety and well-being, helping to provide a positive image of the sport and projecting that opinion to other sectors of society.
11. Shall combat all acts that might discredit or compromise the good name of the FIE and all members of the FIE Family.
12. Shall support technical and professional individuals that manage fencing, keeping them trained and updated on the best practices of good sports management.

13. Shall promulgate the defence of human rights and promote and participate in actions to preserve natural resources and encourage healthy habits.
14. Shall file financial statements with complete and correct information, audited by independent professional auditors, within the time limits and in accordance with the principles of ethical and transparent management.
15. Use their best efforts to protect the referees from any pressure from fencers, trainers, coaches, colleagues, leaders, media or general public.
16. Must know, observe and apply the Model Rules for International Federations for Betting and Anti-Corruption of the Association of Summer Olympic International Federations as modified and accepted by the FIE (hereinafter referred to as "the Model Rules"). The Model Rules are attached as Appendix 1 to this Code and constitute an integral part thereof.

REFEREES

1. Must maintain an objective and impartial stance during the competitions, not being influenced by any pressure from sportsmen, trainers, coaches, colleagues, leaders, media or general public.
2. Must avoid accepting an assignment to referee any match in which they have a perceived or actual "Conflict of Interest" with any participant. Conflict of Interest shall mean any situation where a conflict exists between the duties and the private interests of a referee or judge, in which s/he has direct or indirect private interests that affect, might affect or seem to affect the performance of, in an incorrect way, the referee's or judge's responsibilities and duties as a referee or judge. (*)
3. Shall stay abreast of the rules of fencing and their evolution. They shall exercise their duties efficiently, with the highest motivation and commitment.
4. Shall reach proper decisions taking into account any input from their assistants.
5. Shall treat with respect athletes, coaches and managers, while at the same performing their work and imposing sanctions in order to vigorously enforce the rules.
6. Shall avoid any action that might unfairly compromise or predetermine the outcome of the matches.
7. Shall inform immediately the FIE official or committee of any attempt of corruption and improper activities that might compromise the outcome of a competition.
8. Shall respect the public in any situation, acting politely, objectively and impartially.
9. Shall avoid comments and statements that might generate controversy and undermine the image of the FIE referees or the Member Federations, providing only technical analysis and decisions.
10. Shall not tolerate, in their area of influence, the use of unauthorized drugs or substances, cooperating with the overall efforts in this direction and spreading the negative effects of such practices to the Fencing Family.
11. Shall, in any situation, not tolerate any preference arising from ethnicity, race, colour, gender, religious belief, disability, political orientation, financial, social, or intellectual status, sexual orientation, age and marital status.
12. Shall refrain from promoting, propagandizing, advertising, merchandising, or displaying any brands of medicines, food, tobacco, alcohol and any goods or services that harm or may harm overall health, healthy habits, environment or violate the law.
 - The following is a non-exhaustive list of examples of circumstances under which a conflict of interest could arise. These are included as illustrations to assist referees, judges and arbitrage delegates and the FIE in assessing whether a conflict of interest exists. The Category A potential conflicts are more likely to require action by the referees, judges and arbitrage delegates than those of Category B.
 - Category A Conflicts:

- The referee or judge has or has had the same nationality of an Affected Party. An Affected Party would include a fencer in the bout as well as the trainers or national coaches of such fencer.
 - The referee or judge has or has had a domicile in the country within the last five (5) year of a country of any Affected Party.
 - The referee or judge is or has been employed by an Affected Party within the last five (5) years.
 - The referee or judge is or used to be a relative or partner of an Affected Party.
 - The referee or judge is or was the coach of an Affected Party within the last five (5) years.
- Category B Conflicts:
 - Any of the Category A Conflicts has occurred more than five (5) years of the date of the competition.
 - The referee or judge has other relationships with an Affected Party.

FENCERS

1. Shall compete in the spirit of sportsmanship and fair play. Shall avoid any action that might unfairly compromise or predetermine the outcome of the matches
2. Must be fully aware of, appreciate and enforce rules applicable to the discipline.
3. Shall abide by the directives of the competition management and referees, treating colleagues and opponents with respect. In addition they shall not commit any offensive act in words, actions and gestures, against referees, or the general public nor encourage or induce disrespectful and prejudiced behaviours.
4. Shall defend the interests of fencing in particular and sport in general, with special emphasis on the values, practices and interests of competitiveness, sportsmanship and improvement that should guide the conduct of the athlete.
5. Shall avoid, reject and denounce any form of violence or derision on account of ethnicity, race, colour, gender, religious beliefs, disability, political preference, financial, social or intellectual status, sexual orientation, age or marital status.
6. Shall reject any use of forbidden drugs, unauthorized chemical stimulants, and participation in any active or passive corruption, both on the field of play, and outside it.
7. Shall comply with discipline and, express disagreement, if any, with calm and through proper channels.
8. Shall express their views in a manner responsible, balanced and consistent with the principles and interests of the organization they represent and refrain from public criticism and inappropriate comments about the incidents of the competition, so as not to damage the image of any athlete, referee, manager or technician.
9. Shall refrain from promoting, advertising, marketing, merchandising of any good or service that adversely affects or could adversely affect the general health, healthy habits, the environment or violates applicable law.
10. Should not hide any type of injury which might affect your safe involvement in the sport and cooperate with doctors and trainers analysing your ability to continue your participation.

TRAINERS

1. Shall refrain from expressing public criticism of referees, athletes, officials, competitors, colleagues, media and public by words, actions or behaviours.

2. Should be firmly guiding athletes during training and competition, to participate with sportsmanship, accepting the findings of the referees, and maintaining the respect due to competitors and the public.
3. Shall inform and guide the athletes in the sense of maintaining discipline and calm in the face of possible penalty.
4. Must pay constant attention to the behavior of athletes, to identify, avoid, reject, denounce, deter, prevent and report violence arising on account of ethnic, racial, color, gender, religion or belief, disability, political preference, financial, social, or intellectual condition, sexual orientation, age, marital status.
5. Must avoid, deter, prevent and report use of forbidden drugs or chemical stimulants, as well participation in corruption that compromise the image of the FIE Family they represent or the good name of the sport;
6. Shall refrain from engaging in any act or agreement that may involve unfair advantage, predetermination of the outcome or illicit financial compensation.

4.- IMPLEMENTATION – ETHICS COMMITTEE:

1. In order that the FIE Family shall ensure that observance of the principles and rules of the Olympic Charter and this Code, an Ethics Committee is hereby formed. It shall operate as a temporary body, until the Statutes are amended to make the Ethics Committee a permanent entity.
2. The Ethics Committee issues advisories to the FIE Family on all questions relating to the ethical permissibility of any intended action.
3. Any alleged violation of this Code or an Ethical Committee advisory shall be grounds for lodging a complaint under the Disciplinary Code.
4. Each year, the Ethics Committee will issue a report to the Executive Committee of the FIE relating to the application of this code, noting any advisories given. The Ethics Committee may set out the goals and recommendations for the implementation of the present Code.
5. The Ethics Committee issued its advisories or recommendations by a majority of its neutral members based on the inquiries presented.

The Ethics Committee is made up of 5 members selected by the Executive Committee in the same manner as it selects member of the Council , each being from a different country, and shall hold office during the same period as the rest of councils of the FIE. A member of the Legal Commission shall serve as counsel to the Ethics Committee.

Opinion of the Legal Commission: In favour

Opinion of the Executive Committee:

Proposal 13

Appendix 1

BETTING AND ANTI-CORRUPTION RULES OF THE FIE

1. INTRODUCTION

- 1.1 The integrity of sport depends on the outcome of sporting events and competitions being based entirely on the competing merits of the participants involved. Any form of corruption that might undermine public confidence in the integrity of a sporting contest is fundamentally contrary to the spirit of sport and must be eradicated at all costs.
- 1.2 The International Fencing Federation ("**FIE**") has adopted these rules ("**Rules**") as a means of safeguarding the integrity of the sport of fencing by (i) prohibiting any conduct that may impact improperly on the outcome of its events and competitions and (ii) establishing a mechanism of enforcement and sanction for those who, through their corrupt conduct, place the integrity of fencing at risk.
- 1.3 The FIE is committed to taking all practical and reasonably possible steps within its power to prevent corrupt practices undermining the integrity of the sport of fencing. This commitment shall include:
 - (a) raising awareness of these Rules at all levels, including using existing and/or suitably adapted educational programmes and tools to provide information and educational materials to the widest possible target audience;
 - (b) establishing the best means of monitoring sports betting at International Competitions, including monitoring any irregular betting patterns that may occur;
 - (c) establishing the best means for the receipt of third party information on a confidential basis, for example, by establishing an information 'hot-line';
 - (d) establishing and, where appropriate, making use of effective channels for the exchange of intelligence and information related to the investigation and/or prosecution of Violations under these Rules;
 - (e) co-operating with competent national and international authorities where information in its possession may also amount to or evidence infringements of other applicable laws or regulations; and
 - (f) exchanging information with partners in the Olympic Movement (through ASOIF or otherwise) on acknowledged areas of best practice in relation to combatting corruption in sport.

2. APPLICATION AND SCOPE

- 2.1 These Rules shall apply to all Participants who participate or assist in an International Competition and each Participant shall be automatically bound by, and be required to comply with, these Rules by virtue of such participation or assistance.

- 2.2 It shall be the personal responsibility of every Participant to make himself aware of these Rules including, without limitation, what conduct constitutes a Violation of the Rules and to comply with those requirements. Participants should also be aware that conduct prohibited under these Rules may also constitute a criminal offence and/or a breach of other applicable laws and regulations. Participants must comply with all applicable laws and regulations at all times.
- 2.3 Each Participant submits to the exclusive jurisdiction of the Disciplinary Panel to hear and determine charges brought by the FIE and to the exclusive jurisdiction of CAS to determine any appeal from a Disciplinary Panel decision.
- 2.4 Each Participant shall be bound by these Rules until a date 6 months following his last participation or assistance in a Competition. Each Participant shall continue to be bound by these Rules in respect of his participation or assistance in Competitions taking place prior to that date.
- 2.5 It is recommended that Member Federations and Confederations put in place similar rules and regulations to safeguard the integrity of competitions held under their respective jurisdictions.
- 2.6 Notice under these Rules to a Participant who is under the jurisdiction of a Member Federation or Confederation may be accomplished by delivery of the notice to the Member Federation or Confederation concerned. The Member Federation or Confederation shall be responsible for making immediate contact with the Participant to whom the notice is applicable.

3. **RULE VIOLATIONS**

The following conduct shall constitute a Violation of these Rules (in each case whether effected directly or indirectly):

3.1 **Betting**

- (a) Participation in, support for, or promotion of, any form of Betting related to an Event or Competition (whether one in which the Participant is directly participating or is otherwise taking place in the Participant's sport or is taking place in another sport at an International Competition hosted by a Major Event Organisation in which the Participant is participating), including Betting with another Person on the result, progress, outcome, conduct or any other aspect of such an Event or Competition.
- (b) Inducing, instructing, facilitating or encouraging a Participant to commit a Violation set out in this Rule 3.1.

3.2 **Manipulation of results**

- (a) Fixing or contriving in any way or otherwise improperly influencing, or being a party to fix or contrive in any way or otherwise improperly influence, the result, progress, outcome, conduct or any other aspect of an Event or Competition.
- (b) Ensuring or seeking to ensure the occurrence of a particular incident in an Event or Competition which occurrence is to the Participant's knowledge the subject of a Bet and for which he or another Person expects to receive or has received a Benefit.

- (c) Failing in return for a Benefit (or the legitimate expectation of a Benefit, irrespective of whether such Benefit is in fact given or received) to perform to the best of one's abilities in an Event or Competition.
- (d) Inducing, instructing, facilitating or encouraging a Participant to commit a Violation set out in this Rule 3.2

3.3 **Corrupt Conduct**

- (a) Accepting, offering, agreeing to accept or offer, a bribe or other Benefit (or the legitimate expectation of a Benefit, irrespective of whether such Benefit is in fact given or received) to fix or contrive in any way or otherwise to influence improperly the result, progress, outcome, conduct or any other aspect of an Event or Competition.
- (b) Providing, offering, giving, requesting or receiving any gift or Benefit (or the legitimate expectation of a Benefit, irrespective of whether such Benefit is in fact given or received) in circumstances that the Participant might reasonably have expected could bring him or the sport into disrepute.
- (c) Inducing, instructing, facilitating or encouraging a Participant to commit a Violation as set out in this Rule 3.3.

3.4 **Inside Information**

- (a) Using Inside Information for Betting purposes or otherwise in relation to Betting.
- (b) Disclosing Inside Information to any Person with or without Benefit where the Participant might reasonably be expected to know that its disclosure in such circumstances could be used in relation to Betting.
- (c) Inducing, instructing, facilitating or encouraging a Participant to commit a Violation set out in this Rule 3.4.

3.5 **Other Violations**

- (a) Any attempt by a Participant, or any agreement by a Participant with any other person, to engage in conduct that would culminate in the commission of any Violation of this Rule 3 shall be treated as if a Violation had been committed, whether or not such attempt or agreement in fact resulted in such Violation. However, there shall be no Violation under this Rule 3 where the Participant renounces his attempt or agreement prior to it being discovered by a third party not involved in the attempt or agreement.
- (b) Knowingly assisting, covering up or otherwise being complicit in any acts or omissions of the type described in Rule 3 committed by a Participant.
- (c) Failing to disclose to the [International Federation] or other competent authority (without undue delay) full details of any approaches or invitations received by the Participant to engage in conduct or incidents that would amount to a Violation as set out in this Rule 3.

- (d) Failing to disclose to the FIE or other competent authority (without undue delay) full details of any incident, fact or matter that comes to the attention of the Participant that may evidence a Violation under this Rule by a third party, including (without limitation) approaches or invitations that have been received by any other party to engage in conduct that would amount to a Violation of this Rule;
- (e) Failing to cooperate with any reasonable investigation carried out by the FIE or other competent authority in relation to a possible breach of these Rules, including failing to provide any information and/or documentation requested by the FIE or competent competition authority that may be relevant to the investigation.

3.6 The following are not relevant to the determination of a Violation of these Rules:

- (a) Whether or not the Participant was participating, or a Participant assisted by another Participant was participating, in the specific Event or Competition;
- (b) The nature or outcome of any Bet in issue;
- (c) The outcome of the Event or Competition on which the Bet was made;
- (d) Whether or not the Participant's efforts or performance (if any) in any Event or Competition in issue were (or could be expected to be) affected by the acts or omissions in question;
- (e) Whether or not the results in the Event or Competition in issue were (or could be expected to be) affected by the acts or omissions in question.

4. BURDEN AND STANDARD OF PROOF

- 4.1 The FIE or other prosecuting authority shall have the burden of proving that a Violation has occurred under these Rules. The standard of proof shall be whether the FIE or other prosecuting authority has proved a Violation to the comfortable satisfaction of the Disciplinary Panel, a standard which is greater than the mere balance of probability but less than proof beyond a reasonable doubt.
- 4.2 Where these Rules place the burden of proof on the Participant alleged to have committed a Violation to prove facts or circumstances, the standard of proof shall be by a preponderance of the evidence.
- 4.3 The Disciplinary Panel shall not be bound by judicial rules governing the admissibility of evidence and facts may be established by any reliable means, including but not limited to, admissions, evidence of third parties, witness statements, expert reports, documentary evidence and other analytical information.
- 4.4 The Disciplinary Panel shall have discretion to accept any facts established by a decision of a court or professional disciplinary tribunal of any competent jurisdiction which is not subject to a pending appeal as irrefutable evidence against the Participant to whom the decision relates unless the Participant establishes that the decision violated the principles of natural justice.

- 4.5 The Disciplinary Panel shall be entitled to draw an adverse inference against any Participant who is accused of committing a Violation if that Participant fails to appear in front of the Disciplinary Panel if requested to do so a reasonable time in advance of the hearing, or fails to comply with any information request that has been submitted in accordance with these Rules.

5. INVESTIGATING AND ADJUDICATING A BREACH

- 5.1 Any allegation or suspicion of a Violation of these Rules shall be reported to the FIE for investigation and possible charge in accordance with the Disciplinary Code of the FIE (Statutes Chapter 7), except as specifically stated herein.
- 5.2 No action may be commenced under these Rules against a Participant for a Violation of these Rules unless such action is commenced within three (3) years from the date on which the Violation occurred.

6. AMENDMENTS AND INTERPRETATION

- 6.1 These Rules may be amended from time to time by the FIE.
- 6.2 Betting and anti-corruption rules are, by their nature, competition rules governing the conditions under which the sport of fencing is to be held. They are not intended to be subjected to or limited by the requirements and legal standards applicable to criminal proceedings or employment matters. The policies and standards set out in these Rules as a basis for the fight against corruption in the sport of fencing represent a broad consensus of those with an interest in fair sport and should be respected by all courts and adjudicating bodies.
- 6.3 These Rules shall be interpreted as an independent and autonomous text and not by reference to existing law or statutes, except the Statutes of the FIE.
- 6.4 The headings and sub-headings in these Rules are for convenience only and shall not be deemed to be part of the substance of these Rules or to affect in any way the language of the provisions to which they refer.
- 6.5 The Definitions in Appendix 1 shall be considered an integral part of these Rules.
- 6.6 All references to the masculine gender in these Rules shall also include references to the feminine.
- 6.7 If any Rule or provision of these Rules is held to be invalid, unenforceable or illegal for any reason, it shall be deemed to be deleted and the Rules shall otherwise remain in full force and effect.
- 6.8 These Rules shall come into full force and effect on the date specified by the FIE Congress adopting these rules.

APPENDIX 1

DEFINITIONS

"**Athlete**" means any athlete who participates or is selected to participate in an Event or Competition;

"**Athlete Support Personnel**" means any coach, trainer, manager, athlete representative, agent, team staff member, official, medical or para-medical personnel, family member or any other person employed by or working with an Athlete or the Athlete's Member Federation participating in a Competition.

"**Benefit**" means the direct or indirect receipt or provision (as relevant) of money or money's worth (other than prize money and/or contractual payments to be made under endorsement, sponsorship or other contracts);

"**Bet**" means a wager of money or any other form of financial speculation;

"**Betting**" means making, accepting, or laying a Bet and shall include, without limitation, activities commonly referred to as sports betting such as fixed and running odds, totalisator/toto games, live betting, betting exchange, spread betting and other games offered by sports betting operators;

"**CAS**" means the Court of Arbitration for Sport in Lausanne, Switzerland;

"**Competition**" means an Event or series of Events conducted over one or more days under one ruling body (e.g., World Championships).

"**Disciplinary Panel**" means the members of the FIE Disciplinary Panel appointed by FIE to perform the functions assigned to it in these Rules.

"**Event**" means a single, race, match or contest.

"**Inside Information**" means any information relating to any Competition or Event that a Participant possesses by virtue of his position within the sport. Such information includes, but is not limited to, factual information regarding the competitors, the conditions, tactical considerations or any other aspect of the Competition or Event, but **does not include** such information that is already published or a matter of public record, readily acquired by an interested member of the public or disclosed according to the rules and regulations governing the relevant Competition or Event;

"**International Competition**" means *any official competition of the FIE or other competition under its jurisdiction.*

"**Member Federation**" means the member of the International Federation to which a Participant under these Rules is affiliated directly or through a club or another body affiliated to the member.

"**Major Event Organisation**" means any international multi-sport organisation that acts as the ruling body for any continental, regional or other International Competition.

"**Participant**" means any Athlete, Athlete Support Personnel, judge, referee, delegate, commissioner, jury of appeal member, competition official, Member Federation team or delegation member and any other accredited person;

"Person" shall include natural persons, bodies corporate and unincorporated associations and partnerships (whether or not any of them have separate legal personality);

"Sanction" means any sanction that the Disciplinary Panel has the right to impose in accordance with Disciplinary Code of the FIE; and

"Violation" means a violation of these Rules as set out in Rule 3

Opinion of the Legal Commission: In favour

Opinion of the Executive Committee:

Proposal 14

Amend the Disciplinary Code

7.1.1 Jurisdiction The Disciplinary Panel, selected by the Executive Committee, has sole jurisdiction to rule on all offences against the Rules, [Ethics Code](#), discipline or sportsmanship within the purview of the International Fencing Federation (F.I.E.), except the specific dispositions with respect to discipline at the sites of the competitions to be found in Articles t.114 et seq. of the Rules for Competitions of the F.I.E. The executive committee will assure the respect for and the execution of the decisions of the Disciplinary Panel.

Opinion of the Legal Commission: In favour

Opinion of the Executive Committee:

Proposal of the Medical Commission

Proposal 1 – As Modified – In Favor 6-0

It is proposed that the following text be added to the FIE Statutes:

6.8 ANTI-DOPING PANEL

The Medical Commission will appoint an anti-doping panel of not less than 3 persons, whose members shall come from the Medical Commission. However, if there are insufficient members with adequate experience in anti-doping matters, the Medical Commission will recruit person(s) from outside of the Medical Commission, which person(s) shall require the approval of the Executive Committee.

Motivation:

As with all International Federations, the FIE is obliged to continue with its professional approach to the problem of doping. Even though Fencing is widely regarded as a relatively 'clean' sport, we need to keep it that way by continuing with our comprehensive anti-doping program, as required by the revised 2015 World Anti-Doping Code, and as described in our 2015 FIE Anti-Doping Rules.

We are very satisfied with the administrative work done on behalf of the FIE by the Doping-Free Sport Unit (DFSU) of *SportAccord*, but the FIE must continue to take legal and moral responsibility for directing our sport's anti-doping strategy, and for managing those important aspects of our anti-doping program that cannot be left to the DFSU.

Until now, we have relied on certain members of our Medical Commission who have the required experience in anti-doping matters to act as an "Anti-Doping Commission" and provide the leadership and expertise needed to ensure the proper running of our anti-doping program.

But in view of the fact that the members of FIE Commissions are elected, there is no guarantee that the new members who will be elected to the Medical Commission in 2016 will have the required anti-doping experience.

This potential problem can be best resolved by the proposed modification of the Statutes.

Opinion of the Legal Commission: In favour as mentioned by the medical commission:

6.8 ANTI-DOPING PANEL

The Medical Commission will appoint an anti-doping panel of not less than 3 persons, whose members shall come from the Medical Commission. However, if there are insufficient members with adequate experience in anti-doping matters, the Medical Commission will recruit person(s) from outside of the Medical Commission, which person(s) shall require the approval of the Executive Committee.

Proposals of the Legal, Medical and PP Commissions and Women and Fencing Council

Proposal: As Modified - In Favor 5-1

That the minimum representation of men and women on the FIE Executive Committee and all FIE Commissions and Councils should be raised from 20% to 30%.

Rationale:

In 2007 the Olympic Charter was amended to include, for the first time in history, the following:

"The IOC encourages and supports the promotion of women in sport at all levels and in all structures, with a view to implementing the principle of equality of men and women."
Rule 2, paragraph 7, Olympic Charter in force as from 07.07.2007

The International Olympic Committee (IOC) has publically committed itself to increasing the number of women occupying leadership positions within the Olympic Movement. Twelve years ago, in 2003, the FIE Congress took the decision to require minimum representation of 20% of men and women on the FIE Executive Committee and all FIE Commission.

In line with the commitment of the IOC and best practice in organisational governance, it is now time to increase gender balance in the FIE by increasing the minimum representation of men and women on all FIE Commissions and Councils to 30%.

Proposed changes to FIE Statutes:

Proposal 1

4.3.4: In order to secure the principle of equal treatment, women and men must be represented in overall view by at least ~~20~~ 30% of the elected members of the Executive Committee. If the 15 candidates who have obtained the most votes do not include at least ~~3~~ 5 persons of each gender, the Executive Committee will consist of the ~~3~~ 5 candidates for the Executive Committee who have obtained the greatest number of votes of the gender not otherwise being so represented and the ~~4~~ 10 candidates of the other gender who have obtained the greatest number of votes.

If there are less than ~~3~~ 5 candidates of either gender, that gender will be represented by the number of candidates put forward and the remainder of the Executive Committee will consist of the candidates of the other gender who have obtained the most votes.

Opinion of the Legal Commission: In favour as modified:

Executive Committee

4.3.4 In order to secure the principle of equal treatment, women and men **each** must be represented ~~in overall view~~ by at least ~~20%~~ 30% of the elected members of the Executive Committee. If the 15 candidates who have obtained the most votes do not include at least ~~3~~ 5 persons of each gender, the Executive Committee will consist of the ~~3~~ 5 candidates for the Executive Committee **of the under- represented gender** who have obtained the greatest

number of votes ~~of the gender not otherwise being so represented~~ and the ~~12~~ 10 candidates of the other gender who have obtained the greatest number of votes.

If there are ~~less~~ fewer than ~~3~~ 5 candidates of either gender, that gender will be represented by the number of candidates put forward and the remainder of the Executive Committee will consist of the candidates of the other gender who have obtained the most votes.

Proposal 2

4.4.4: If the 10 first members elected do not include ~~two~~ 3 members of each gender, the Commission will consist of the first ~~8~~ 7 members elected and the ~~two~~ 3 members of the other gender who are candidates for the commission and who have obtained the greatest number of votes. If no candidate of either gender has offered herself/himself as candidates, the 10 candidates of different nationalities with the greatest number of votes are elected.

Opinion of the Legal Commission: In favour as modified:

Commissions

4.4.4 If the 10 ~~first members elected~~ candidates who have obtained the most votes do not include ~~at least 3 persons of each gender, two members of each gender,~~ the Commission will consist of ~~the first 8 members elected and the two members of the other gender who are candidates for the commission~~ the 3 candidates of the under-represented gender who have obtained the greatest number of votes and the 7 candidates of the other gender who have obtained the greatest number of votes.

If no candidate of ~~either one of the genders~~ has ~~offered herself/himself as candidates~~ been nominated, the 10 candidates ~~of different nationalities of the other gender~~ with the greatest number of votes are elected.

If there are fewer than 5 candidates of either gender, that gender will be represented by the number of candidates put forward and the remainder of the Commission will consist of the candidates of the other gender who have obtained the most votes.

Councils

4.7.6 Candidacies permitting, there must be at least 30% persons of each gender on each of the Councils.

Proposals from the Veterans ~~to~~ Council to the Executive Committee

Proposal 9 – AsModified – In Favor 6-0

ADMINISTRATIVE RULES

6.2 Amounts to be paid to the organisers:

Subject	Euros
Individual entry fee Cadets, Juniors, Seniors, Veterans World Championships	55
Team entry fee Juniors, Seniors, Veterans World Championship	140
<u>Supplemental Referee fee Individual Veterans World championships (Referee Fee)</u>	45
<u>Referee Supplemental fee Team Veterans World championships (Referee Fee)</u>	45

BETTING AND ANTI-CORRUPTION RULES OF THE FIE

Appendix I of the FIE Ethics Code

Based on the MODEL RULES FOR INTERNATIONAL FEDERATIONS

BETTING AND ANTI-CORRUPTION issued by the ASSOCIATION OF SUMMER OLYMPIC INTERNATIONAL FEDERATIONS ("ASOIF")

1. INTRODUCTION

- 1.1 The integrity of sport depends on the outcome of sporting events and competitions being based entirely on the competing merits of the participants involved. Any form of corruption that might undermine public confidence in the integrity of a sporting contest is fundamentally contrary to the spirit of sport and must be eradicated at all costs.
- 1.2 The International Fencing Federation ("FIE") has adopted these rules ("Rules") as a means of safeguarding the integrity of the sport of fencing by (i) prohibiting any conduct that may impact improperly on the outcome of its events and competitions and (ii) establishing a mechanism of enforcement and sanction for those who, through their corrupt conduct, place the integrity of fencing at risk.
- 1.3 The FIE is committed to taking all practical and reasonably possible steps within its power to prevent corrupt practices undermining the integrity of the sport of fencing. This commitment shall include:
 - (a) raising awareness of these Rules at all levels, including using existing and/or suitably adapted educational programmes and tools to provide information and educational materials to the widest possible target audience;
 - (b) establishing the best means of monitoring sports betting at International Competitions, including monitoring any irregular betting patterns that may occur;
 - (c) establishing the best means for the receipt of third party information on a confidential basis, for example, by establishing an information 'hot-line';
 - (d) establishing and, where appropriate, making use of effective channels for the exchange of intelligence and information related to the investigation and/or prosecution of Violations under these Rules;
 - (e) co-operating with competent national and international authorities where information in its possession may also amount to or evidence infringements of other applicable laws or regulations; and

- (f) exchanging information with partners in the Olympic Movement (through ASOIF or otherwise) on acknowledged areas of best practice in relation to combatting corruption in sport.

2. APPLICATION AND SCOPE

- 2.1 These Rules shall apply to all Participants who participate or assist in an International Competition and each Participant shall be automatically bound by, and be required to comply with, these Rules by virtue of such participation or assistance.
- 2.2 It shall be the personal responsibility of every Participant to make himself aware of these Rules including, without limitation, what conduct constitutes a Violation of the Rules and to comply with those requirements. Participants should also be aware that conduct prohibited under these Rules may also constitute a criminal offence and/or a breach of other applicable laws and regulations. Participants must comply with all applicable laws and regulations at all times.
- 2.3 Each Participant submits to the exclusive jurisdiction of the Disciplinary Panel to hear and determine charges brought by the FIE and to the exclusive jurisdiction of CAS to determine any appeal from a Disciplinary Panel decision.
- 2.4 Each Participant shall be bound by these Rules until a date 6 months following his last participation or assistance in a Competition. Each Participant shall continue to be bound by these Rules in respect of his participation or assistance in Competitions taking place prior to that date.
- 2.5 It is recommended that Member Federations and Confederations put in place similar rules and regulations to safeguard the integrity of competitions held under their respective jurisdictions.
- 2.6 Notice under these Rules to a Participant who is under the jurisdiction of a Member Federation or Confederation may be accomplished by delivery of the notice to the Member Federation or Confederation concerned. The Member Federation or Confederation shall be responsible for making immediate contact with the Participant to whom the notice is applicable.

3. RULE VIOLATIONS

The following conduct shall constitute a Violation of these Rules (in each case whether effected directly or indirectly):

3.1 Betting

- (a) Participation in, support for, or promotion of, any form of Betting related to an Event or Competition (whether one in which the Participant is directly participating or is otherwise taking place in the Participant's sport or is taking place in another sport at an International Competition hosted by a Major Event Organisation in which the Participant is participating), including Betting with another Person on the result, progress, outcome, conduct or any other aspect of such an Event or Competition.

- (b) Inducing, instructing, facilitating or encouraging a Participant to commit a Violation set out in this Rule 3.1.

3.2 Manipulation of results

- (a) Fixing or contriving in any way or otherwise improperly influencing, or being a party to fix or contrive in any way or otherwise improperly influence, the result, progress, outcome, conduct or any other aspect of an Event or Competition.
- (b) Ensuring or seeking to ensure the occurrence of a particular incident in an Event or Competition which occurrence is to the Participant's knowledge the subject of a Bet and for which he or another Person expects to receive or has received a Benefit.
- (c) Failing in return for a Benefit (or the legitimate expectation of a Benefit, irrespective of whether such Benefit is in fact given or received) to perform to the best of one's abilities in an Event or Competition.
- (d) Inducing, instructing, facilitating or encouraging a Participant to commit a Violation set out in this Rule 3.2

3.3 Corrupt Conduct

- (a) Accepting, offering, agreeing to accept or offer, a bribe or other Benefit (or the legitimate expectation of a Benefit, irrespective of whether such Benefit is in fact given or received) to fix or contrive in any way or otherwise to influence improperly the result, progress, outcome, conduct or any other aspect of an Event or Competition.
- (b) Providing, offering, giving, requesting or receiving any gift or Benefit (or the legitimate expectation of a Benefit, irrespective of whether such Benefit is in fact given or received) in circumstances that the Participant might reasonably have expected could bring him or the sport into disrepute.
- (c) Inducing, instructing, facilitating or encouraging a Participant to commit a Violation as set out in this Rule 3.3.

3.4 Inside Information

- (a) Using Inside Information for Betting purposes or otherwise in relation to Betting.
- (b) Disclosing Inside Information to any Person with or without Benefit where the Participant might reasonably be expected to know that its disclosure in such circumstances could be used in relation to Betting.
- (c) Inducing, instructing, facilitating or encouraging a Participant to commit a Violation set out in this Rule 3.4.

3.5 Other Violations

- (a) Any attempt by a Participant, or any agreement by a Participant with any other person, to engage in conduct that would culminate in the commission of any

Violation of this Rule 3 shall be treated as if a Violation had been committed, whether or not such attempt or agreement in fact resulted in such Violation. However, there shall be no Violation under this Rule 3 where the Participant renounces his attempt or agreement prior to it being discovered by a third party not involved in the attempt or agreement.

- (b) Knowingly assisting, covering up or otherwise being complicit in any acts or omissions of the type described in Rule 3 committed by a Participant.
- (c) Failing to disclose to the [International Federation] or other competent authority (without undue delay) full details of any approaches or invitations received by the Participant to engage in conduct or incidents that would amount to a Violation as set out in this Rule 3.
- (d) Failing to disclose to the FIE or other competent authority (without undue delay) full details of any incident, fact or matter that comes to the attention of the Participant that may evidence a Violation under this Rule by a third party, including (without limitation) approaches or invitations that have been received by any other party to engage in conduct that would amount to a Violation of this Rule;
- (e) Failing to cooperate with any reasonable investigation carried out by the FIE or other competent authority in relation to a possible breach of these Rules, including failing to provide any information and/or documentation requested by the FIE or competent competition authority that may be relevant to the investigation.

3.6 The following are not relevant to the determination of a Violation of these Rules:

- (a) Whether or not the Participant was participating, or a Participant assisted by another Participant was participating, in the specific Event or Competition;
- (b) The nature or outcome of any Bet in issue;
- (c) The outcome of the Event or Competition on which the Bet was made;
- (d) Whether or not the Participant's efforts or performance (if any) in any Event or Competition in issue were (or could be expected to be) affected by the acts or omissions in question;
- (e) Whether or not the results in the Event or Competition in issue were (or could be expected to be) affected by the acts or omissions in question.

4. BURDEN AND STANDARD OF PROOF

4.1 The FIE or other prosecuting authority shall have the burden of proving that a Violation has occurred under these Rules. The standard of proof shall be whether the FIE or other prosecuting authority has proved a Violation to the comfortable satisfaction of the Disciplinary Panel, a standard which is greater than the mere balance of probability but less than proof beyond a reasonable doubt.

4.2 Where these Rules place the burden of proof on the Participant alleged to have committed a Violation to prove facts or circumstances, the standard of proof shall be by a preponderance of the evidence.

- 4.3 The Disciplinary Panel shall not be bound by judicial rules governing the admissibility of evidence and facts may be established by any reliable means, including but not limited to, admissions, evidence of third parties, witness statements, expert reports, documentary evidence and other analytical information.
- 4.4 The Disciplinary Panel shall have discretion to accept any facts established by a decision of a court or professional disciplinary tribunal of any competent jurisdiction which is not subject to a pending appeal as irrefutable evidence against the Participant to whom the decision relates unless the Participant establishes that the decision violated the principles of natural justice.
- 4.5 The Disciplinary Panel shall be entitled to draw an adverse inference against any Participant who is accused of committing a Violation if that Participant fails to appear in front of the Disciplinary Panel if requested to do so a reasonable time in advance of the hearing, or fails to comply with any information request that has been submitted in accordance with these Rules.

5. INVESTIGATING AND ADJUDICATING A BREACH

- 5.1 Any allegation or suspicion of a Violation of these Rules shall be reported to the FIE for investigation and possible charge in accordance with the Disciplinary Code of the FIE (Statutes Chapter 7), except as specifically stated herein.
- 5.2 No action may be commenced under these Rules against a Participant for a Violation of these Rules unless such such action is commenced within three (3) years from the date on which the Violation occurred.

6. AMENDMENTS AND INTERPRETATION

- 6.1 These Rules may be amended from time to time by the FIE.
- 6.2 Betting and anti-corruption rules are, by their nature, competition rules governing the conditions under which the sport of fencing is to be held. They are not intended to be subjected to or limited by the requirements and legal standards applicable to criminal proceedings or employment matters. The policies and standards set out in these Rules as a basis for the fight against corruption in the sport of fencing represent a broad consensus of those with an interest in fair sport and should be respected by all courts and adjudicating bodies.
- 6.3 These Rules shall be interpreted as an independent and autonomous text and not by reference to existing law or statutes, except the Statutes of the FIE.
- 6.4 The headings and sub-headings in these Rules are for convenience only and shall not be deemed to be part of the substance of these Rules or to affect in any way the language of the provisions to which they refer.
- 6.5 The Definitions in Appendix 1 shall be considered an integral part of these Rules.
- 6.6 All references to the masculine gender in these Rules shall also include references to the feminine.

- 6.7 If any Rule or provision of these Rules is held to be invalid, unenforceable or illegal for any reason, it shall be deemed to be deleted and the Rules shall otherwise remain in full force and effect.
- 6.8 These Rules shall come into full force and effect on the date specified by the FIE Congress adopting these rules.

APPENDIX 1

DEFINITIONS

"**Athlete**" means any athlete who participates or is selected to participate in an Event or Competition;

"**Athlete Support Personnel**" means any coach, trainer, manager, athlete representative, agent, team staff member, official, medical or para-medical personnel, family member or any other person employed by or working with an Athlete or the Athlete's Member Federation participating in a Competition.

"**Benefit**" means the direct or indirect receipt or provision (as relevant) of money or money's worth (other than prize money and/or contractual payments to be made under endorsement, sponsorship or other contracts);

"**Bet**" means a wager of money or any other form of financial speculation;

"**Betting**" means making, accepting, or laying a Bet and shall include, without limitation, activities commonly referred to as sports betting such as fixed and running odds, totalisator/toto games, live betting, betting exchange, spread betting and other games offered by sports betting operators;

"**CAS**" means the Court of Arbitration for Sport in Lausanne, Switzerland;

"**Competition**" means an Event or series of Events conducted over one or more days under one ruling body (e.g., World Championships).

"**Disciplinary Panel**" means the members of the FIE Disciplinary Panel appointed by FIE to perform the functions assigned to it in these Rules.

"**Event**" means a single, race, match or contest.

"**Inside Information**" means any information relating to any Competition or Event that a Participant possesses by virtue of his position within the sport. Such information includes, but is not limited to, factual information regarding the competitors, the conditions, tactical considerations or any other aspect of the Competition or Event, but **does not include** such information that is already published or a matter of public record, readily acquired by an interested member of the public or disclosed according to the rules and regulations governing the relevant Competition or Event;

"**International Competition**" means *any official competition of the FIE or other competition under its jurisdiction.*

"**Member Federation**" means the member of the International Federation to which a Participant under these Rules is affiliated directly or through a club or another body affiliated to the member.

"**Major Event Organisation**" means any international multi-sport organisation that acts as the ruling body for any continental, regional or other International Competition.

"**Participant**" means any Athlete, Athlete Support Personnel, judge, referee, delegate, commissioner, jury of appeal member, competition official, Member Federation team or delegation member and any other accredited person;

"**Person**" shall include natural persons, bodies corporate and unincorporated associations and partnerships (whether or not any of them have separate legal personality);

"Sanction" means any sanction that the Disciplinary Panel has the right to impose in accordance with Disciplinary Code of the FIE; and

"Violation" means a violation of these Rules as set out in Rule 3.

F.I.E. ETHICAL CODE / F.I.E. CODE OF ETHICS

1.-INTRODUCTION

The FIE Ethics Code is based on the IOC Code of Ethics and aims to preserve the ethical values and principles that inspire the Olympic Charter and which must inspire, in any case, the performance of the members of the International Community of Fencing understood in the broadest manner (hereinafter, also referred to as or "FIE Family").

The FIE Ethics Code ("Code") defines the principles of conduct that should regulate sports and administrative activities of the entity and the FIE Family. The Code aims to promote and safeguard the ideals of dignity, integrity, cooperation, sportsmanship and fair competition, which should characterize the performance of all components of the FIE Family.

The FIE Community includes: directors, officers and members of the FIE, the Member Federations and Confederations recognized by the FIE and their managers, the members of the Organizing Committees of official competitions and the representatives of the candidate cities for the organization of official competitions as well as fencers, coaches, referees, other members of national delegations participating in any competition or event developed under the umbrella of the FIE, and as applicable, employees, partners and service providers directly or indirectly linked to the FIE.

2. ETHICAL FUNDAMENTALS, PRINCIPLES AND RULES

The FIE Family is obliged to respect and ensure respect for the following principles and rules, particularly with regard to the organization and development any official competition, event or activity recognized by the FIE.

I.- Dignity:

1. It must safeguard the dignity of any person as a fundamental requirement of Olympism and the FIE.
2. There should exist, in any situation, respect and consideration for the FIE Family and the general public, in order to assert the principles of legality, sportsmanship and fair competition.
3. There will be no discrimination among the FIE Family because of race, gender, religion, political or philosophical opinion, family or any other status.
4. No practice that violates the physical or mental integrity of the FIE Family will be tolerated. Any practice related to doping, at any level, is absolutely prohibited. The anti-doping rules contained in the FIE Anti-Doping Code will be scrupulously observed.
5. All forms of physical, psychological, professional or sexual harassment are prohibited.
6. Competition organizers will ensure the necessary conditions of security, welfare and medical care to promote the physical and mental balance for the FIE Family.

II.- Integrity:

1. The FIE Family must reject and denounce any form of corruption or unfair favoritism, of whatever nature, ensuring the honesty and dignity of the sport.

2. The FIE Family may not directly or indirectly, request, accept or offer any concealed remuneration, commission, benefit or service of any nature connected with the organisation of official Championships, activities or events or their function as FIE officials.

Any concealed commission, compensation, benefit or service of any nature, that is received by an officer of the FIE, must be declared in writing to the FIE office within 30 days of its receipt, when its total value exceeds € 150. In case of doubt as to the value, the FIE Family member may request an opinion of the Ethics Committee.

The Ethics Committee will review the declared cases and shall decide, within 90 days, that the beneficiary of such benefits is the FIE, or that they must be returned to their source.

3. Only gifts whose total value is less than 150 €, can be given and accepted by the members of the FIE Family, as a sign of respect and friendship.
Any gift worth more than € 150 must be declared in writing the Ethics Committee, which will decide as noted in paragraph 2.
4. The hospitality shown to members, officers and directors of the FIE Family and their companions, may not exceed normal standards. Invitations for trips offered by the organizers of competitions or events, or the Member Federations (except the one of which the officer is member), that are not based on a cooperation agreement between the organizer and the Member Federation or the FIE, must be declared to the Ethics Committee before the trip occurs. The Ethics Committee may suggest that such person decline the invitation if it is contrary to the Code.
5. The FIE Family must avoid any conflict of interest among themselves, the organization to which they belong and any other person or organization related to the Olympic movement. If a conflict of interest arises or might arise, parties shall inform the Ethics Committee of the FIE.
6. The FIE Family members shall act with the care and diligence required to perform their duties, not acting in any way to harm the reputation of fencing or the Olympic movement.
7. The FIE Family must not be complicit nor have any relationship with entities or individuals whose activity are below standard, conflicting or inconsistent with the principles of the Olympic Charter or this Code.
8. The FIE Family will never give nor accept instructions to vote or to intervene in a given or pre-established manner within the FIE bodies or organs.

III.- "Fair Play":

The concept of "fair play," beyond mere compliance with the rules and regulations, extends to the notions of loyalty, mutual respect and sportsmanship. It covers the fight against any use in the competition of unfair advantage, cunning, doping, violence (physical and verbal), inequality of opportunity or corruption.

Sport is a positive activity that enriches the individual and society provided it is practiced in an honest and honourable way, so it is the duty of all members of the FIE Family to avoid behaving in a manner contrary to fair play in the broadest sense of the concept.

IV.- Resources:

1. FIE resources may be used only for fencing and Olympic purposes.

2. Revenue and expenditures of the FIE will be recorded in accordance with recognized international financial reporting standards, and those accounts shall be audited by an independent professional auditor.
3. The FIE Family recognizes the important contribution that the media, sponsors, partners and other supporters of sporting events make for the development and prestige of the Olympic movement around the world. However, said support must be appropriate and consistent with the rules of the sport and the principles defined in the Olympic Charter and this Code. The organization and conduct of sports competitions is the sole responsibility of the FIE and the Member Federations recognized by the FIE.

V.- Candidatures:

The FIE Family members shall respect all aspects of the FIE statutes and rules adopted relating to candidate cities for the organization of official championships or competitions.

VI.- Relationships with Countries:

1. The FIE Family members will work to maintain harmonious relations with the authorities of the countries of the Member Federations, in accordance with the principles of universality and political neutrality. However, the spirit of humanism, fraternity and respect for human rights that inspires the Olympic ideal requires governments of countries of Member Federations where official competitions and other events of the FIE take place, to ensure that the principles of the Olympic Charter and this Code are scrupulously respected.
2. The FIE Family members are free to develop public functions in the countries to which they belong. However, they may not engage in any activity or follow an ideology which implicitly contradicts the principles and rules defined in the Olympic Charter or those laid down in this Code.
3. The FIE Family members undertake to protect the environment in any event organized under the auspices of the FIE, committing to maintain these activities under generally accepted environmental standards.

V.- Confidentiality:

Except as otherwise noted in this Code, The FIE Family members will keep secret any information received in confidence. Disclosure of any information must not be for personal benefit, nor be done maliciously to damage the reputation of any person or organization.

3.- RULES OF CONDUCT.-

All members of the FIE Family should always be inspired by the above binding rules and ethical principles, which lead to the following Rules of Conduct.

The Rules of Conduct generate responsibilities, rights and obligations to be assumed in the various areas of sports performance and the various levels of the organization and administration of the sport of Fencing.

THE FIE FAMILY

1. Must know, observe and apply the laws, statutes, rules and regulations governing the practice of fencing.
2. Shall concentrate the initiative and commitment of the entity in order to promote the legitimate interests of fencing within the parameters of transparency, honesty and sportsmanship, promoting and dignifying the correct practice of the sport of fencing.
3. Shall cooperate with the IOC, NOCs of the Member Federations, governments, sponsors and investors holding bonds of respect and consideration, and stressing the importance of sport for the social development, culture, education and health of its practitioners.
4. Shall strengthen and maintain relationships with all media, in order to ensure the integrity and objectivity desirable of all information related to fencing in addition to promote the sport in the public eye.
5. Shall take all necessary measures to ensure security on the premises where the competitions are held, primarily considering the physical and moral well-being of everyone involved in event.
6. Shall maintain proper conduct, avoiding engagement in actions that cause harm to their own credibility or compromise the image of the FIE and the FIE Family.
7. Shall prevent, deter and denounce (and encourage the reporting of any), use of unauthorized substances, unfair benefit, or any type of corruption in the practice of fencing.
8. Shall prohibit the FIE Family from suggesting or recommending promotion, advertising or publicity of any good or service that can harm general health, healthy habits, environment.
9. Shall prohibit and report to the Ethics Committee any kind of preferences or prejudices arising from ethnicity, colour, gender, religious belief, disability, political orientation, financial, social, or intellectual status, sexual orientation, age, marital status, among other forms of social exclusion, in any competition.
10. Shall punish acts of violence that jeopardize the physical and moral integrity of the FIE Family, media and general public, ensuring their safety and well-being, helping to provide a positive image of the sport and projecting that opinion to other sectors of society.
11. Shall combat all acts that might discredit or compromise the good name of the FIE and all members of the FIE Family.
12. Shall support technical and professional individuals that manage fencing, keeping them trained and updated on the best practices of good sports management.
13. Shall promulgate the defence of human rights and promote and participate in actions to preserve natural resources and encourage healthy habits.
14. Shall file financial statements with complete and correct information, audited by independent professional auditors, within the time limits and in accordance with the principles of ethical and transparent management.
15. Use their best efforts to protect the referees from any pressure from fencers, trainers, coaches, colleagues, leaders, media or general public.
16. Must know, observe and apply the Model Rules for International Federations for Betting and Anti-Corruption of the Association of Summer Olympic International Federations as modified and accepted by the FIE (hereinafter referred to as "the Model Rules"). The Model Rules are attached as Appendix 1 to this Code and constitute an integral part thereof.

REFEREES

1. Must maintain an objective and impartial stance during the competitions, not being influenced by any pressure from sportsmen, trainers, coaches, colleagues, leaders, media or general public.
2. Must avoid accepting an assignment to referee any match in which they have a perceived or actual "Conflict of Interest" with any participant. Conflict of Interest shall mean any situation where a conflict exists between the duties and the private interests of a referee or judge, in which s/he has direct or indirect private interests that affect, might affect or seem to affect the performance of, in an incorrect way, the referee's or judge's responsibilities and duties as a referee or judge. (*)
3. Shall stay abreast of the rules of fencing and their evolution. They shall exercise their duties efficiently, with the highest motivation and commitment.
4. Shall reach proper decisions taking into account any input from their assistants.
5. Shall treat with respect athletes, coaches and managers, while at the same performing their work and imposing sanctions in order to vigorously enforce the rules.
6. Shall avoid any action that might unfairly compromise or predetermine the outcome of the matches.
7. Shall inform immediately the FIE official or committee of any attempt of corruption and improper activities that might compromise the outcome of a competition.
8. Shall respect the public in any situation, acting politely, objectively and impartially.
9. Shall avoid comments and statements that might generate controversy and undermine the image of the FIE referees or the Member Federations, providing only technical analysis and decisions.
10. Shall not tolerate, in their area of influence, the use of unauthorized drugs or substances, cooperating with the overall efforts in this direction and spreading the negative effects of such practices to the Fencing Family.
11. Shall, in any situation, not tolerate any preference arising from ethnicity, race, colour, gender, religious belief, disability, political orientation, financial, social, or intellectual status, sexual orientation, age and marital status.
12. Shall refrain from promoting, propagandizing, advertising, merchandising, or displaying any brands of medicines, food, tobacco, alcohol and any goods or services that harm or may harm overall health, healthy habits, environment or violate the law.
 - The following is a non-exhaustive list of examples of circumstances under which a conflict of interest could arise. These are included as illustrations to assist referees, judges and arbitrage delegates and the FIE in assessing whether a conflict of interest exists. The Category A potential conflicts are more likely to require action by the referees, judges and arbitrage delegates than those of Category B.
 - Category A Conflicts:
 - The referee or judge has or has had the same nationality of an Affected Party. An Affected Party would include a fencer in the bout as well as the trainers or national coaches of such fencer.
 - The referee or judge has or has had a domicile in the country within the last five (5) year of a country of any Affected Party.
 - The referee or judge is or has been employed by an Affected Party within the last five (5) years.
 - The referee or judge is or used to be a relative or partner of an Affected Party.
 - The referee or judge is or was the coach of an Affected Party within the last five (5) years.

- Category B Conflicts:
 - Any of the Category A Conflicts has occurred more than five (5) years of the date of the competition.
 - The referee or judge has other relationships with an Affected Party.

FENCERS

1. Shall compete in the spirit of sportsmanship and fair play. Shall avoid any action that might unfairly compromise or predetermine the outcome of the matches
2. Must be fully aware of, appreciate and enforce rules applicable to the discipline.
3. Shall abide by the directives of the competition management and referees, treating colleagues and opponents with respect. In addition they shall not commit any offensive act in words, actions and gestures, against referees, or the general public nor encourage or induce disrespectful and prejudiced behaviours.
4. Shall defend the interests of fencing in particular and sport in general, with special emphasis on the values, practices and interests of competitiveness, sportsmanship and improvement that should guide the conduct of the athlete.
5. Shall avoid, reject and denounce any form of violence or derision on account of ethnicity, race, colour, gender, religious beliefs, disability, political preference, financial, social or intellectual status, sexual orientation, age or marital status.
6. Shall reject any use of forbidden drugs, unauthorized chemical stimulants, and participation in any active or passive corruption, both on the field of play, and outside it.
7. Shall comply with discipline and, express disagreement, if any, with calm and through proper channels.
8. Shall express their views in a manner responsible, balanced and consistent with the principles and interests of the organization they represent and refrain from public criticism and inappropriate comments about the incidents of the competition, so as not to damage the image of any athlete, referee, manager or technician.
9. Shall refrain from promoting, advertising, marketing, merchandising of any good or service that adversely affects or could adversely affect the general health, healthy habits, the environment or violates applicable law.
10. Should not hide any type of injury which might affect your safe involvement in the sport and cooperate with doctors and trainers analysing your ability to continue your participation.

TRAINERS

1. Shall refrain from expressing public criticism of referees, athletes, officials, competitors, colleagues, media and public by words, actions or behaviours.
2. Should be firmly guiding athletes during training and competition, to participate with sportsmanship, accepting the findings of the referees, and maintaining the respect due to competitors and the public.
3. Shall inform and guide the athletes in the sense of maintaining discipline and calm in the face of possible penalty.
4. Must pay constant attention to the behavior of athletes, to identify, avoid, reject, denounce, deter, prevent and report violence arising on account of ethnic, racial, color, gender, religion or belief, disability, political preference, financial, social, or intellectual condition, sexual orientation, age, marital status.

5. Must avoid, deter, prevent and report use of forbidden drugs or chemical stimulants, as well participation in corruption that compromise the image of the FIE Family they represent or the good name of the sport;
6. Shall refrain from engaging in any act or agreement that may involve unfair advantage, predetermination of the outcome or illicit financial compensation.

4.- IMPLEMENTATION – ETHICS COMMITTEE:

1. In order that the FIE Family shall ensure that observance of the principles and rules of the Olympic Charter and this Code, an Ethics Committee is hereby formed. It shall operate as a temporary body, until the Statutes are amended to make the Ethics Committee a permanent entity.
2. The Ethics Committee issues advisories to the FIE Family on all questions relating to the ethical permissibility of any intended action.
3. Any alleged violation of this Code or an Ethical Committee advisory shall be grounds for lodging a complaint under the Disciplinary Code.
4. Each year, the Ethics Committee will issue a report to the Executive Committee of the FIE relating to the application of this code, noting any advisories given. The Ethics Committee may set out the goals and recommendations for the implementation of the present Code.
5. The Ethics Committee issued its advisories or recommendations by a majority of its neutral members based on the inquiries presented.

The Ethics Committee is made up of 5 members selected by the Executive Committee in the same manner as it selects member of the Council , each being from a different country, and shall hold office during the same period as the rest of councils of the FIE. A member of the Legal Commission shall serve as counsel to the Ethics Committee.

Appendix 1

BETTING AND ANTI-CORRUPTION RULES OF THE FIE

FIE - GOOD GOVERNANCE – PROPOSAL FOR IMPLEMENTATION

Abbreviations:

BUP = Basic Universal Principle of Good Governance

EB = Executive Body (i.e.) Executive Committee)

LB = Legislative Body (i.e. Congress)

Score:

0 to 4, with 4 being best

#	Good Governance Principle	Score	Evaluation (June 2014) / Proposal for Implementation
0. Vision, Mission and Strategy			
1.1	The vision and overall goals of the organisations have to be clearly defined and communicated	4	- See Statutes, p. 5 <i>et seq.</i> - See official website: http://www.fie.org/fie/structure
			No need for change
0.2 = IOC BUP 1.2	The mission should include: <ul style="list-style-type: none"> • Development and promotion of sport through non-profit organisations • Promotion of the values of sport • Organisation of competitions • Ensuring a fair sporting contest at all times • Protection of the members and particularly the athletes • Solidarity • Respect for the environment 	3	- not explicitly mentioned are: fairness, protection of members (esp. athletes), solidarity, respect for the environment - in comparison mission of IOC: http://www.olympic.org/about-ioc-institution
			- Respect for environment is now included in Statutes, 1.1 lit. k - fair play is part of proposed Code of Ethics - <u>Proposal: Amendment to Statutes 1.1</u> "The aims of the F.I.E. are: <u>l) to ensure fair sporting contests so that the spirit of fair play prevails.</u> <u>m) to establish rules and appropriate measures to protect the health of athletes and prevent any abuse.</u> <u>n) to take appropriate means to provide for the social and professional future of athletes.</u>

Code de champ modifié

Code de champ modifié

Legal Commission

0.3 =IO C BUP 1.3	The strategy is to be aligned with the vision and regularly adapted to the Environment	4	No need for change
0.4 =IO C BUP 1.4	The strategy of sporting organisations should be elaborated at the highest level of the organisation	4	No need for change
1. Organizational Transparency			
IOC BUP, 2.2: All regulations of each organisation and governing body, including but not limited to, statutes/constitutions and other procedural regulations, should be clear, transparent, disclosed, publicised and made readily available.			
1.1	FIE publishes on its website its statutes and by-laws	4	http://www.fie.ch/Fencing/Status.aspx
			Update: http://fie.org/fie/documents/statuses-and-administrative-rules → no need for change
1.2	FIE publishes on its website its sports rules	4	http://www.fie.ch/Fencing/Rules.aspx
			Update: http://fie.org/fie/documents/rules → no need for change
1.3	FIE publishes on its website its LB (<i>legal body, i.e. Congress</i>), members' basic information (name, address, date of creation for organisations, date of birth, nationality, gender for natural persons)	3	http://www.fie.ch/Addresses/AddrFed.aspx → missing: date of creation
			Update: http://fie.org/fie/structure/federations-map Proposal: Adding date of creation for federations
1.4	FIE publishes on its website its EB (<i>executive body, i.e. Executive Committee</i>) members' and senior managers' biographical and contact information	2	http://www.fie.ch/Addresses/AddrMember.aspx?Group=ComEx → missing: biographical information
			Update: http://fie.org/fie/structure/executive-committee Proposal: Adding biographical information Example: http://www.olympic.org/mr-thomas-bach

Code de champ modifié

Code de champ modifié

Code de champ modifié

Code de champ modifié

Code de champ modifié

Code de champ modifié

Code de champ modifié

Code de champ modifié

Code de champ modifié

Legal Commission

1.5	FIE publishes on its website its organisation chart	4	http://www.fie.ch/download/organisation/FIE%20headoffice%20chart.pdf Problem: location, ease of access http://www.fie-ch.www6.iomedia.infomaniak.ch/en/inside-fie/structure-1-7 http://www.fie.org/en/inside-fie/structure-1-7 Update: http://fie.org/fie/structure → no need for change
1.6	FIE publishes on its website its vision/mission/values and strategic objectives	1	- Only in Statutes - Missing on official website, but see http://www.fie-ch.www6.iomedia.infomaniak.ch/en/inside-fie/who-we-are-1-1 → not as detailed as in Statutes Update: http://fie.org/fie/structure Proposal: Add subitem "mission and values"
1.7	FIE publishes on its website the agenda of its LB meetings	4	http://www.fie.ch/Fencing/Agenda.aspx → here only the dates → agenda of Congress is published via information letters Update: http://fie.org/fie/agenda → no need for change
1.8	FIE publishes on its website newsletters and/or press releases	3	Press release: http://www.fie.ch/Communication/Press.aspx → last: 2011 → other homepage: http://www.fie-ch.www6.iomedia.infomaniak.ch/en/media/press.php?idIndex=2 Newsletters: http://www.fie.ch/Fencing/Letters.aspx → not really a newsletter → http://www.fie-ch.www6.iomedia.infomaniak.ch/en/fanzone/pages/e-magazine-0-2729 Update: http://fie.org/media/press/3 → no need for change

Code de champ modifié

Code de champ modifié

Code de champ modifié

Code de champ modifié

Code de champ modifié

Code de champ modifié

Code de champ modifié

Code de champ modifié

Code de champ modifié

Code de champ modifié

Code de champ modifié

Code de champ modifié

Code de champ modifié

1.9	FIE publishes on its website an annual activity report	3	- only via letters → Problems: transparency, arranged only chronologically, not by topic Update: http://fie.org/fie/documents/reports → no need for change
2. Reporting Transparency			
IOC BUP, 2.2: All regulations of each organisation and governing body, including but not limited to, statutes/constitutions and other procedural regulations, should be clear, transparent, disclosed, publicised and made readily available. Clear regulations allow understanding, predictability and facilitate good governance. The procedure to modify or amend the regulations should also be clear and transparent.			
2.1	FIE publishes or makes available reports on its main events (championships, cups, etc.)	3	- RSS Feed: (-) - Media site is outdated: "On Screen" 2008, Press Release etc. 2011 - results: http://www.fie.ch/Competitions/Calendar.aspx?results=true - http://www.fie.org/en/events/catania-1-30 Update: http://fie.org/competitions/calendar http://fie.org/results-statistic → no need for change
2.2	FIE opens its Legislative Body meetings to media or publishes their minutes	4	Via letters Update: http://fie.org/fie/documents/reports → no changes needed
2.3	FIE annually publishes its Standing Bodies (<i>i.e. Commissions</i>) reports	4	Via letters Update: http://fie.org/fie/documents/documents-of-commissions-and-councils/1 → no need for change

Code de champ modifié

Code de champ modifié

Code de champ modifié

Code de champ modifié

Code de champ modifié

Legal Commission

2.4 = 4.3/ 4.4 IOC BUP	FIE annually publishes an externally audited financial report according to recognized international standards (IFRS2 or similar)	3	- External auditor audits annual financial statement for Congress: only conformity to Suisse law - published via letters
			<u>Proposal, Amendment of Statutes 3.2.1:</u> "The Congress appoints professional auditors as auditors for the following fiscal year, which can be renewed. <u>The report of the auditors shall be based on recognized international financial reporting standards.</u> "
2.5 = 4.4 IOC BUP	FIE annually publishes compensation benefits and/or salary of its president	0	- only general costs of personnel in annual balance sheet
			<u>Proposal, Amendment of Statutes, 5.8.1:</u> <u>"g) The Treasurer is responsible for drafting the financial report according to Article 3.2.1. It shall include separate statements concerning travel expenses and allowances granted to the President."</u>
2.6	FIE annually publishes financial allowances of its voluntary EB members	0	- only general costs of personnel in annual balance sheet
			<u>Proposal, Amendment of Statutes, 5.8.1:</u> <u>"g) The Treasurer is responsible for drafting the financial report according to Article 3.2.1. It shall include separate statements concerning travel expenses and allowances granted to the President and the members of the Executive Committee."</u>
2.7	FIE annually publishes salaries and benefits of its senior managers	0	- only general costs of personnel in annual balance sheet
			- General costs are published. - Publishing individual benefits could infringe privacy laws. → no recommendation for change
2.8	FIE annually publishes amount of income tax paid and to whom	0	- not included in annual balance sheet
			- In case information about income tax paid is part of IFRS standards this requirement will be met. Otherwise there is no need for any further changes. → no recommendation for change

Legal Commission

2.9	FIE has an archival policy to give access to its archives for scholars and media	-	No explicit archival policy
			No need for change
2.9.1 =2.3 IOC BUP	The tasks and responsibilities of the governing bodies should be clearly defined in the applicable regulations and should be adapted and reviewed as necessary	4	see Statutes
			No need for change
3. Stakeholders' Representation			
IOC BUP, 2.4 - Representative governing bodies: Members of the organisation should be represented within the governing bodies. Special care should be taken for protection and representation of minority groups			
3.1 = 6.1 IOC BUP	Athletes are represented in the FIE bodies	3	- Athletes' Commission → only consultative → no personal entanglement between Athletes' Commission and EB - indirectly via national federations - comparison to IOC and FIFA: IOC can consist of up to 15 active athletes, no necessity, no necessity to nominate athletes to EBs
			- Statutes, 5.2.5 → now fulfilled → no need for change
3.2	The athletes' entourage (coaches, agents, medical staff, etc.) are represented in the FIE bodies.	4	- Existing Commissions: Athletes, Medical, SEMI, Rules, Legal, Promotion
			No need for change
3.3	Judges / referees are represented in the FIE bodies	4	Refereeing Commission
			No need for change
3.4	Clubs are represented in the FIE bodies	2	only indirectly, via national federations
			Firstly, this criterion is not required by IOC Good Governance Principles. Secondly, indirect representation via member federations is sufficient. → no recommendation for change

Legal Commission

3.5	Leagues are represented in the FIE bodies	-	Not applicable
			No need for change
3.6	Event organising committees are represented in the FIE bodies	0	Event organizing committees are not represented
			No recommendation for change
3.7	Media partners are represented in the FIE bodies	0	Media partners are currently not represented
			No recommendation for change
3.8	Commercial partners (sponsors, suppliers...) are represented in the FIE bodies	0	Commercial partners are currently not represented
			No recommendation for change
4. Structures and Democratic Process			
<p>IOC BUP, 2.1: Structures: All sports organisations in the Olympic and Sports Movement should be based on the concept of membership within entities established in accordance with applicable laws. The sports organisations should include as members legal or physical persons who constitute the organisation and contribute to form the will of the organization. The stakeholders of the organisation encompass all members who make up the organisation as well as all external entities who are involved and have a link, relation with or interest in the organization</p> <p>IOC BUP, 2.5: Democratic processes: Democratic processes, such as elections, should be governed by clear, transparent and fair rules</p>			
4.1 =2.7 IOC BUP	FIE organs meet regularly (annually for LB and several times a year for EB) Bodies of the organisation should meet on a regular basis taking into consideration their specific duties and obligations (e.g. the holding of an annual General Assembly is recommended where possible)	4	No need for change
4.2	FIE organs' members are elected on the basis of secret ballots and procedures detailed in its statutes	4	No need for change
4.3	FIE has detailed regulation for the candidatures to its presidency	4	No need for change

Legal Commission

4.3.1 = 2.3 IOC BUP	The organisation should set out and adopt reliable and appropriate criteria for the election or appointment of members of the governing bodies so as to ensure a high level of competence, quality and good governance	4	No need for change
4.4 cf. 2.8 IOC BUP	FIE organs' major decisions are taken by secret ballots and members with a conflict of interest are excluded from the vote. (As a general principle, members of any decision-making body should be independent in their decisions. No-one with a personal or business interest in the issue under discussion should be involved in the decision.)	2	<p><u>a. Secret ballot:</u> - Statutes, 3.5.6: "At the Congress the vote is secret on any point which concerns an individual person or a Member Federation, or on the decision of the Chairman of the meeting, or at the request of at least 25% of the members present." → IOC Charter, 18.4: „Voting is held by secret ballot when so required by the Olympic Charter (e.g. 19.2.1, election of members to IOC EB), or if the Chairman so decides or upon the request of at least a quarter of the members present.“</p> <p><u>b. Conflict of interest:</u> - with regard to conflict of interests the only rule in Statutes is 7.6.2 (concerning Disciplinary Panel): "“When it is necessary to engage a Disciplinary Tribunal, the Legal Commission, or a sub-committee thereof selected for this purpose, will eliminate those members of the D.P. who have a conflict of interest, either because of the countries represented in the controversy or because of involvement in the incident in another role (e.g. DT, Arbitrage, etc.). It will then select the 3 members of the Disciplinary Tribunal by lots to be designated as the Tribunal, plus one additional person, also selected by lots, to be the alternate, who shall be substituted on the Tribunal if one of the 3 persons originally chosen is not available or shall be determined to have a conflict of interest which causes that person to be eliminated from the Tribunal. The Legal Commission shall designate the president of the Disciplinary Tribunal. Any member of the Tribunal selected by the Legal Commission shall have the responsibility to disclose any relationships with the parties and to refuse to accept any assignment to a Tribunal where there is a conflict of interest.” - Rule 1.2.8 (reference to IOC, Code of Ethics)</p>

Legal Commission

			<p>→ in comparison: IOC, Code of Ethics: very detailed in pp. 95-99, applies to all decision-making bodies</p> <p>The current proposal for a Code of Ethics deals with conflict of interest. It is recommended to develop the rules concerning conflict of interest within the Code of Ethics, according to the IOC Code of Ethics. No further regulatory change is needed.</p>
4.5	FIE organs' major decisions are taken on the basis of written reports supported by Criteria	2	<p>- Congress: Statutes, 3.2.1 and 3.4.2 - decisions of Congress are based on information letter with all relevant information and annual report of EB - decisions of EB: not required under AR</p> <p><u>Proposal: Amendment of AR 5.1.2.2</u> "The agenda of the meeting will reach each of the members of the Executive Committee at least 15 days before the meeting. In case of an emergency, the President may decide to add a point to the agenda at any time before the meeting.</p> <p>Each member of the Executive Committee may make a request for an item to be on the agenda at the latest 12 days before the meeting.</p> <p><u>If possible the points for discussion shall be accompanied by relevant documentation so as to provide adequate information and thereby facilitate the discussion and enable well-informed decisions."</u></p>
4.5.1 =	All members of the sports organisations shall have the right to express their opinion on the issues on the agenda through appropriate channels	4	<p>Statutes, 3.4.1 and 6.4.3</p> <p>No need for change</p>

Legal Commission

2.7 IOC BUP			
4.5. 2 = 2.7 IOC BUP	Members shall have the right to vote and be able to exercise that right in appropriate form as defined in the regulations of the governing body	4	Statutes, 3.5.5 No need for change
4.5. 3 = 2.7 IOC BUP	Decision-making bodies should be fully aware of all relevant information before taking a decision	-	- unspecific principle - enabled by 4.5 (written reports for major decisions) No need for change
4.6 = 2.9 IOC BUP	FIE EB's members have a term limit The duration of the terms of office should be pre-determined in order to allow election / renewal of office-bearers on a regular basis (e.g. every four years). Access for new candidates should be encouraged.	4	- Statutes, 4.1.1 - Term period is limited to 4 years - There is no limit of number of terms IOC Good Governance Principles only require for predetermination of duration of terms, not for limited term number. → No need/recommendation for change
4.7	FIE EB's members have an age limit	2	- Minimum age - no maximum age → Nothing in IOC BUP, however IOC Charter, 3.3: age limit of 70 years - The IOC Good Governance Principles do not require an age limit. - Possible issue of age discrimination → no recommendation for change
4.8	FIE EB's members and senior managers reflect the sport gender balance	2	- Statutes, 4.3.4: for election of Executive Committee: 20 % - Statutes, 4.4.4: for election of Commissions: 2 out of 10 - current situation: 17 male, 5 female, equals 22 %

Legal Commission

			The rules on good governance do not prescribe the means of achieving gender balance and thus do not prescribe a certain level of quota. This is open for Congress to decide.
4.9	FIE EB's members and senior managers reflect an appropriate geographical balance	4	- 5.2.4: president of geographic zones as ex-officio member - 4.4.4, 4.5.12, 4.6.4, 4.7.5: for Commissions - 4.1.2 for Executive Committee
			No need for change
4.9.1 =2.3 IOC BUP	The size of the governing bodies should be adequate and consistent with the size of the sports organisations	4	No need for change

Legal Commission

4.9. 2 = 2.3 IOC BUP	Governing bodies should be entitled to create standing or ad hoc committees with specific responsibilities, in order to help them in their tasks	4	Statutes, 6.1.2 No need for change
4.9. 3 = 2.6 IOC BUP	A clear allocation of responsibilities between the different bodies such as general assembly, executive body, committees or disciplinary bodies, should be determined	4	No need for change
4.9. 4 = 2.6 IOC BUP	There should be a balance of power between the bodies responsible for the management, supervision and control of the sport organisations. There is a Principle of checks and balances	?	No recommendation for change
4.10 = 3.5 IOC BUP	Appointment of the members of the management The majority of the members of management should be professional. Candidates should have professional competency and an impeccable professional history. The selection process should be based on objective criteria and should be set out clearly	?	Proposal, Amendment to AR, 5.1.5: <u>According to Article 5.6.2 of the Statutes the President may employ, with the approval of the Executive Committee, the personnel necessary to run the F.I.E. efficiently. Candidates should have professional competency and an impeccable professional history. The selection process should be based on objective criteria and should be set out clearly.</u>

5. Control mechanisms			
<p>IOC BUP, 4.1 – Accountability: All bodies, whether elected or appointed, shall be accountable to the members of the organisation and, in certain cases, to their stakeholders. In particular, the executive body shall be accountable to the General Assembly of the organization. Management shall be accountable to the executive body. All employees shall be accountable to management</p> <p>IOC BUP, 4.2 - Processes and mechanisms: Adequate standards and processes for accountability should be in place and available to all organisations, and consistently applied and monitored. Clear and measurable objectives and targets must be set for the organisation, its boards, management and staff, including also appropriate tools for assessment.</p> <p>IOC BUP, 4.3 - Transparency and communication: Financial information should be disclosed gradually and in appropriate form to members, stakeholders and the public. Disclosure of financial information should be done on an annual basis. The financial statements of sports organisations should be presented in a consistent way in order to be easily understood</p> <p>IOC BUP, 4.4 - Financial matters – applicable laws, rules, procedures and standards: Accounts should be established in accordance with the applicable laws and “True and fair view” principle. The application of internationally recognised standards should be strongly encouraged in all sports organisations, where possible, and required for an international body. For all organisations, annual financial statements are to be audited by independent and qualified auditors. Accountability and financial reports should be produced on a regular basis. Information about remuneration and financial arrangements of the governing bodies’ members should be part of the annual accounts. Clear rules regarding remuneration of the members of governing bodies and managers should be enforced. Remuneration procedures should be transparent and predictable.</p> <p>IOC BUP, 4.5 - Internal Control system: Internal control of the financial processes and operations should be established within the sports organisations</p> <p>The adoption of a compliance system, document retention system and information security system should be encouraged. The structure of the internal control system should depend on the size and importance of the organization. Audit committees should be appointed for large sports organisations.</p>			
5.1 =4.2 IOC BUP	FIE has adopted a code or principles of governance Adequate standards and processes for accountability should be in place and available to all organisations, and consistently applied and monitored. Clear and measurable objectives and targets must be set for the organisation, its boards, management and staff, including also appropriate tools for assessment.	1	<ul style="list-style-type: none"> - Statutes, 1.2.8: “The FIE recognises the fundamental principles of the Olympic Charter, the application of the Code of Ethics of the International Olympic Committee and the competence of the Commission of Ethics of the International Olympic Committee.” - AR 5.1.1.1, 5.1.1.2: work plan and supervision (concerning Commissions) - AR 5.2: supervision and direction (concerning CEO) - Nothing about governance/accountability <p><u>Proposal, Amendment to Statutes 5.5.1:</u> “The Executive Committee ensures the management of the F.I.E. between congresses in accordance with the Statutes and takes the most suitable measures for the development of fencing world wide. Management of the F.I.E. is based on principles of accountability, compliance and good</p>

			<p><u>governance.”</u></p> <p><u>Proposal, Amendment to AR, 5.2:</u> <u>There shall be a reporting system of the staff, whether they are based in the FIE head office or outside. Staff shall report to the CEO on a regular basis. The CEO shall report to the President and Secretary General on a regular basis.</u></p>
5.2 = 3.4/ 4.5 IOC BUP	<p>FIE has an internal integrated control and risk management system (COSO3 or similar)</p> <p>A clear and adequate risk-management process should be put in place: Identification of potential risks for the sports organisations, Evaluation of risks, Control of risks, Monitoring of risks, Disclosure/transparency</p>	0	<p>- Nothing in Statutes or AR</p> <p>- Control system required by 4.5 IOC BUP</p> <p><u>Proposal, Amendment to Statutes 5.5.1:</u> The Executive Committee ensures the management of the F.I.E. between congresses in accordance with the Statutes and takes the most suitable measures for the development of fencing world wide. <u>Management of the F.I.E. is based on principles of accountability, compliance and good governance. Appropriate measures to identify and minimize potential risks shall be adopted.</u></p> <p><u>See also 4.5</u> <u>Proposed Amendment of AR 5.1.2.2</u> “The agenda of the meeting will reach each of the members of the Executive Committee at least 15 days before the meeting. In case of an emergency, the President may decide to add a point to the agenda at any time before the meeting.</p> <p>Each member of the Executive Committee may make a request for an item to be on the agenda at the latest 12 days before the meeting.</p> <p><u>If possible the points for discussion shall be accompanied by relevant documentation identifying potential risks so as to provide adequate information and thereby facilitate the discussion and enable well-informed decisions.”</u></p>

Legal Commission

5.3 = 4.5 IOC BUP	FIE has an audit and remuneration committee or similar, distinct from the finance committee	0	- External auditor - Desirable? IOC itself does not have an audit committee
			No change recommended; would require to set-up another committee; additional benefit to auditor is questionable
5.4	An elected independent member sits on the FIE's Executive Body to safeguard proper decision making on behalf of the members	0	- Not applicable
			No recommendation for change
5.5 = 3.1 IOC BUP	FIE has a committee to perform due diligence on the members of its bodies and senior managers based on FIT (=The Fit and Proper test for Approved Persons) or similar Competence of the members of the executive body Members of the executive body should be chosen on the basis of their ability, competence, quality, leadership capacity, integrity and experience	0	- Statutes: 4.4.2 (requirements for Commissions' membership) - FIT criteria: honesty, integrity, reputation, competence, capability - Desirable?
			No change recommended; would require setup of new committee; concerning members of other bodies this would feel like supervision, but this power ultimately lies with Congress; concerning senior managers this is within the power of the CEO
5.5. 1 = 3.2 IOC BUP	Power of signature Good governance implies proper financial monitoring In order to avoid any abuse of powers of representation (in particular signing), adequate rules should be set up, approved and monitored at the highest level. Precise, clear and transparent regulations should be established and applied, and effective controlling systems and checks and balances should be put in place As a general rule, individual signature should be avoided for binding obligations of an organization	?	- Statutes, 5.6.3: power of sole signature for President - Statutes: 5.8.1: sole signature with prior approval; limit is determined by COMEX - Example FIFA, Organisation Regulations 5.1: "The FIFA President represents FIFA (art. 32 par. 1 of the FIFA Statutes) and is recorded in the Swiss Commercial Register as having joint powers of signature (with one other person)."
			<u>Proposal, Amendment of Statutes 5.6.1, 5.6.3 and 5.6.4:</u> 5.6.1 The President is the legal representative of the International Fencing Federation. If he is unable to attend <u>any meetings</u> , he is replaced by the Secretary General.
5.6	FIE separates regulatory and commercial functions	?	- no specific rules - part of general rules concerning powers and responsibilities → ultimately responsibility of Congress, for urgent decisions: EC
			No recommendation for change

Legal Commission

5.7	FIE observes open tenders for its major marketing and procurement contracts	?	- nothing in Statutes or AR 1. Amendment of Statutes, 10.1 <u>10.1.3. Member federations who organize official FIE competitions observe open tenders for their marketing, media and procurement contracts.</u> [Alternatively or concurrently: Amendment of Handbook of Regulations for organizing competitions] 2. Amendment of Statutes, 1.2.8 <u>The F.I.E. and its bodies observe open tenders for their marketing, media and procurement contracts.</u>
5.8 = 2.10 IOC BUP	FIE decisions can be contested through well-defined internal channels specified in its statutes and bye-laws Any member affected by a decision of a disciplinary nature taken by any sports organisation should be offered the possibility to submit an appeal to an independent body within the sport's jurisdictions	2	- Statutes, 7.2.7: only concerning decisions made by the Disciplinary Tribunal - IOC's BUP only require for appeal against decisions of a disciplinary nature. This is in place. - Decisions of COMEX can be "appealed" by Congress. → No recommendation for change
5.8.1 = 2.10 IOC BUP	When decisions are taken against a member, special attention should be paid to the appropriate balance between transparency and protection of privacy	?	- Statutes 7.2.2, 7.2.4, 7.2.12 - Ethics Code? No recommendation for change
5.9	FIE recognizes the Court of Arbitration for sport (or similar) as an external channel of complaint and dispute resolution	4	Statutes, 7.2.7 No change needed
6. Sport integrity and Highest Level of Competence			
6.1 = 3.6 IOC BUP	FIE has or recognizes an Ethics/Integrity Code for its organs' members and staff including guidelines for receiving/giving gifts from/to individuals or organisations Develop, adapt and implement ethical principles and rules Ethical rules should refer to and be inspired by	1	- Statutes, 1.2.8: recognition of IOC Code of Ethics; 4.1.3: rejection of candidates - IOC Ethics Code linked on homepage - Chapter 11 Administrative Rules: only ethical principle is impartiality, rather code of conduct, no reference to IOC Code of Ethics - No monitoring

Legal Commission

	the IOC Code of Ethics. Monitor the implementation of ethical principles and rules		Code of Ethics is currently in development, no further change is needed.
6.2 = 2.8 IOC BUP	FIE has state-of-the-art conflict of interest regulations Adequate procedures should be established in order to avoid any conflicts of interests.	1	- only rule: Statutes, 4.6.5: Disciplinary Panel - No reference to IOC rules - No monitoring - (P) When is conflict of interest regulations state-of-the-art?!? Code of Ethics dealing with conflict of interest is currently in development, no further change is needed.
6.3 = 6.6 IOC BUP	FIE has rules concerning betting on its sports or recognizes the SportAccord code of conduct and model rules on sports integrity in relation to sports betting	1	- FIE is member of SportAccord → automatic recognition? Betting is also part of proposal for Code of Ethics. The proposal so far deals only with managers and federations, should be expanded to all officials and fencers.
6.4	FIE has an independent body (e.g. Ethics Commission) to monitor the application of the rules presented in 6.1, 6.2 and 6.3, to initiate investigation proactively and to propose sanctions	0	- No such Commission exists - No other procedure for monitoring Ethics Committee will be implemented by proposed Code of Ethics. → No further change needed.

Legal Commission

6.5	FIE has a confidential reporting mechanism to manage comments and allegations by whistle blowers	0	<p>Currently no provision concerning whistle blowers. Statutes 7.2.2 provides for confidentiality, but not between the parties involved.</p> <p>The proposed Code of Ethics provides for a right to inform. The Code could provide for confidentiality especially as the Ethics Committee has no decision-making power. However, such draft must have regulations precluding any abuse. It is recommended to deal with confidential a reporting mechanism within the Code of Ethics.</p>
6.6 = 6.4 IOC BUP	FIE recognizes and complies with the World Anti-Doping Code Sports organisations shall fight against doping and uphold anti-doping policy. Zero tolerance in the fight against doping should be encouraged in all sports organizations at all levels. Sports organisations shall protect the athletes from doping in particular through prevention and education.	4	<ul style="list-style-type: none"> - No direct reference in statutes - Statutes, 7.1.7, 9.1.1: reference to FIE Anti-Doping Rules - Obligation of member states: AR 1.2, 8.3 - FIE Anti-Doping rules: Reference to World Anti-doping Code (“based on and compliant with”; EC has recognized the Code) - Anti Doping Programme “Outreach”: http://www-fie-ch.www6.iomedia.infomaniak.ch/multimedia/docs/2013/04/2013_04_11_Anti_doping_outreach_programme_completed_yesterday_2.pdf <p>Updated link for “Outreach” programme: http://fie.org/uploads/4/22650-2013_04_11_Antidoping_outreach_programme_completed_yesterday_2.pdf → No change is needed</p>

Code de champ modifié

Code de champ modifié

Legal Commission

6.7	FIE major events respect the principles of sustainable development and adopt an environmental management system (ISO5 14000 or similar)	0	- Nothing in Statutes or Handbooks - General rule in Statutes 1.1. lit. k (aims of the FIE): "to apply appropriate measures to contribute to the respect of the environment"
			<p>Proposal: Amendment of Statutes 10.2.1 lit. b: "When it puts forward its candidature, a federation must present a full dossier which complies with the FIE instructions, and make a commitment before the Congress to comply with the specifications set down by the FIE and to respect its financial obligations <u>as well as the environment and the principle of sustainable development.</u></p> <p>A regulatory specification on how to fulfill this commitment (e.g. via ISO standard) is not recommended. However, it is recommended that the Handbook of regulations or the bid questionnaire require the candidate to specify how it intends to fulfill this commitment.</p>
6.8	FIE has integrity awareness / education programmes for its main stakeholders	0	No such programme exists
			<p>Within the power of COMEX or budgetary power of Congress → No recommendation</p>
6.8.1 = 4.6 IOC BUP	There should be an induction programme for all new members of staff, volunteer officers and all board members. Ongoing education and training of executives, volunteers and employees should be integral to operations. The promotion of self-education and regular training within the sport organisations should be encouraged.	2	AR, Preamble to Chapter 5: Integration session for newly elected or appointed members to Executive Committee, Commissions and Councils → BUP also provides for ongoing education and training of staff.
			<p>Within the power of COMEX (or CEO) → No recommendation</p>
6.9	FIE collaborates with governmental and non-governmental agencies on integrity issues	?	Unspecific principle
			No recommendation

Legal Commission

6.11 = 3.3 IOC BUP	Good internal communication reinforces the efficiency of sporting organisations. Good information flow inside sporting organisations ensures good understanding by membership of activities undertaken and allows managers to make timely and informed decisions. Good working conditions and atmosphere as well as motivation and incentive policies are essential for the smooth functioning of the organisation	?	- Relevant for information flow within COMEX, within FIE Office and between COMEX and FIE Office
			- Decisive is implementation in practice. - Not a regulatory question. - Requirement for internal reporting (see recommendation 5.1) → no further recommendation
<p>7. Solidarity</p> <p>IOC BUP, 5.1 - Distribution of resources: As a principle, financial resources which are proceeds of sport should be allocated to sport and in particular to its development after covering all necessary sports-related costs. Financial revenues should be distributed in a fair and efficient manner. A fair distribution of the financial revenues contributes to having balanced and attractive competitions. A clear and transparent policy for the allocation of the financial revenues is essential.</p> <p>IOC BUP, 5.2 - Equity: Resources should be distributed equitably. The equity in sport should be reinforced. The right to participate in competitions should be encouraged and secured for those at an appropriate level for the athletes concerned. The opportunity to organise large sports events should be open. The criteria for choosing venues for events should be fair and transparent.</p> <p>IOC BUP, 5.3 – Development: The development of partnership relations between different sports organisations in developing countries should be encouraged. The expansion of sports facilities in developing countries should be promoted</p>			
7.1 = 5.1 IOC BUP	FIE invests an adequate part of its surplus in its declared non-profit objectives	?	- two biggest parts of budget go to administration (2013: CHF 2 803 435) and development (2013: CHF 2 809 877) - outside of FIE: International Charity Fund for the Future of Fencing - IOC Olympic Solidarity
			Within the budgetary power of Congress → No recommendation
7.2 = 5.1 IOC BUP	FIE has a financial redistribution policy and programmes for its main stakeholders	2	- Olympic Games Revenues: CHF 14 418 807 - distribution to confederations: see development plan above - no specific programme in Statutes or AR
			- Update: Club Movement Initiative: http://fie.org/development/projects/4 → No recommendation

Code de champ modifié

Legal Commission

7.3	FIE audits the use of funds given to its main stakeholders	4	- see above (general financial audit) - competence of Congress
			No need for change
7.4	FIE has programmes for the development of its sport at elite and grassroots levels	2	- two programmes: Training schools in Dakar and Martiny - financial redistribution: see above and budget
			- Update: Club Movement Initiative: http://fie.org/development/projects/4 - Within the power of COMEX and budgetary power of Congress → No recommendation
7.5	FIE has an environmental and social responsibility policy and programmes in place	2	- unspecific principle - respect for environment now in Statutes - social responsibility in the broader sense part of Code of Ethics - no programme in place
			- not a regulatory question - power of COMEX and/or budgetary power of Congress → no recommendation
7.6 = 6.7 IOC BUP	FIE has career and education programmes to assist its athletes during the transition to their post-athletic careers Educational programmes, developing in particular “Sport and Studies” programmes, should be encouraged. Career management programmes should be promoted. Training professional athletes for new professional opportunities after their sports careers should be encouraged	4	- FIE Athletes Career Programme: http://www-fie-ch.www6.iomedia.infomaniak.ch/en/inside-fie/FIE-ACP-2014-1-3125 → has started in 2014
			- Update: http://fie.org/uploads/4/22641-2013_08_08_FIE_launching_FIE_Athletes_Career_Programme_2014.pdf - Results and impressions should be awaited → no recommendation at this point
7.7	FIE has programmes or resources to assist the communities which host its events in their legacy planning	?	- Cahier des charges?
			- not a regulatory question - power of COMEX and/or budgetary power of Congress → no recommendation

Code de champ modifié

Code de champ modifié

Code de champ modifié

7.8	FIE audits the use of funds given to its social responsibility programmes	4	- see above (general financial audit) - Competence of Congress - no specific, well-regulated mode of monitoring/auditing
			No need for change
7.9	FIE elaborates with governmental and non-governmental agencies on social responsibility issues	?	unspecific principle
			No recommendation
7.10 = 5.2 IOC BUP	The opportunity to organise large sports events should be open. The criteria for choosing venues for events should be fair and transparent.	?	- opportunity is open - Transparency of criteria? Nothing in Statutes, but bid questionnaire and handbook of regulations
			No need for change
<p>8. Athletes Involvement</p> <p>IOC BUP, 6.1 - Right to participate and involvement of the athletes in the Olympic and Sports Movement and governing bodies: The right of athletes to participate in sports competitions at an appropriate level should be protected. Sports organisations must refrain from any discrimination. The voice of the athletes should be heard in sporting organisations.</p> <p>IOC BUP, 6.2 - Protection of athletes: Measures should be taken to prohibit exploitation of young athletes. Athletes should be protected from unscrupulous recruiters and agents. Cooperation with the government of the countries concerned should be developed. Codes of conduct should be signed by all sport organisations.</p> <p>IOC BUP, 6.3 – Health: Sports organisation shall adopt rules for the protection of the athletes' health and to limit the risk of endangering the athletes' health (medical supervision, number of days of competition, pollution, etc.)</p> <p>IOC BUP, 6.5 – Insurance: Insurance in case of death or serious injury is to be recommended for all athletes and should be mandatory for young / junior athletes. Whenever and wherever possible, athletes should be provided with social security coverage. Special insurance policies should be available for professional athletes. The organisers of sports events should obtain adequate insurance coverage.</p> <p>IOC BUP, 6.6 - Fairness and Fair play: Fairness and fair play are central elements of the competition. Fair play is the spirit of sport. The values of sport and friendship shall be promoted. The undue influence of betting shall be avoided</p>			
8.1	Participation of athletes without discrimination	4	- Participation at competitions: ... - see above for Athletes' Commission (organizational participation)
			No need for change
8.2	Protection of athletes/Code of conduct	?	- Proposed Code of Ethics
			No need for change

Legal Commission

8.3	Rules for protection of athletes' health	4	- Medical Commission, Legal and Rules Commission, homologation (international standard tests; see Annex A of Material Rules) - in general competition rules No need for change
-----	--	---	--

Minutes of the FIE Medical Commission Special Meeting
July 30-August 1, 2015
Crowne Plaza Budapest, Bucharest, Romania
Submitted by Antonio Fiore, MD (ITA), FIE Medical Commission President

Members present: Antonio Fiore (ITA; President); Wilfried Wolfgarten (GER), George Ruijsch van Dugteren (NED), Clare Halsted (GBR), Peter Harmer (AUS), Maha Mustafa Mourad (EGY), Jeno Kamuti (HUN), Mohamed Neji Daly (TUN), Ezequiel Rodriguez-Rey (PAN)

Excused: Catherine Defoligny-Renault (FRA)

Ex-officio: Ērika Āze (Executive Committee liaison) (LAT)

Meeting called to order at 10:00am on Thursday July 30, 2015, by Commission President Fiore (ITA).

*Summary of decisions and recommendations
of the 2015 Medical Commission meeting*

Proposals for the 2015 Congress

(Please refer to the attached document PROPOSALS)

- *Page 1:* Proposal 1 of the Medical Commission – Change to Statutes: 6.8 Anti-doping Panel
 - **Opinion of the Medical Commission:** In favor of Proposal (in form of modification as follows):

The Medical Commission will appoint an anti-doping panel of not less than 3 persons, whose members shall come from the Medical Commission. However, if there are insufficient members with adequate experience in anti-doping matters, the Medical Commission will recruit person(s) from outside of the Medical Commission, which person(s) shall require the approval of the Executive Committee.

- *Page 2:* Proposal of the Legal, Medical & PP Commissions and Women and Fencing Council – Proportion of women on Executive Committee and all Commissions and Councils be raised to 30%. Proposal 1 and 2
 - **Opinion of the Medical Commission:** In favor

- *Page 3:* Proposal 10 of ComEx – m.25.7 (Mask) modifications
 - **Opinion of the Medical Commission:** In favor

Goals for the Medical Commission

(I) Lead role for safety within the FIE

- This should be the responsibility of the Medical Commission. This issue will also be considered by FIMS (Fédération Internationale de Médecine Sportive).

(II) Anti-Doping

- van Dugteren raised the issue of the need to increase the number of OOC tests, the new tests required, and related budgetary issues.
- The Commission was informed of the incident involving a fencer that was found positive in an anti doping screening for the diuretic Chlorazasil. Upon further study it was discovered that it is a catabolite of an anti malaria drug, Malarone, whose metabolic path was not known. Dr. Fiore had the intuition that Malarone could have determined the presence of a molecule very similar to Chlorazasil in the athlete's organism. Dr. van Dugteren promptly conveyed Fiore's hypothesis to WADA. The hypothesis proved to be correct and this finding is now part of the literature. Most importantly, the athlete in question could continue to compete without any sanction against her.

Recommendations for Action

1. Medical Cahier des Charges

- 1.1. Medical Cahier des Charges must be integral to the bid process for FIE events, especially World C'ships, not just an add-on. **Implementation:** Immediately.
- 1.2. Organizers must confirm in writing compliance with the Medical Cahier des Charges at least one (1) month prior to the beginning of competitions. **Implementation:** Immediately.
- 1.3. To consult with Comex and the Legal Commission about sanctions for organizers who do not follow the medical Cahier des Charges. Failing to adhere to the Cahier increases the likelihood of a fatal outcome in the case of a catastrophic injury or medical event (this recommendation was also submitted 2013, 2014). **Implementation:** Beginning of 2015-16 season.

2. Roles of Medical Commission Delegates

- 2.1. Request from ComEx clarification and specific details of which events will require Medical Commission delegates. There is currently confusion, especially regarding Zonal Championships and Zone Games. **Implementation:** Immediately.
- 2.2. Establish the responsibilities for Medical delegates at continental Games (e.g., Pan American Games). **Implementation:** Immediately.
- 2.3. Request from ComEx clarification and specific details of how many Medical Commission delegates are to be assigned to each event, including a request for the local organizing committee to ensure that visas—when necessary—are facilitated speedily. Due to the increased work requirements the following recommendations are made:
 - 2.3.1. at least three (3) Medical Commission Delegates for the Open and Junior and Cadet World Championships;
 - 2.3.2. two (2) Delegates for the Veterans World Championships;
 - 2.3.3. one (1) delegate for Zonal Championships and Zone Games (this recommendation was submitted after the 2007, 2010, 2013, 2014 meetings).**Implementation:** Beginning for 2016 Junior/Cadet World C'ship.

3. Roles of the Medical Commission in the Zones

- 3.1. Request that ComEx ensures that the organizers of Zonal competitions are aware of, and adhere to, the requirements of the Medical Handbook. **Implementation:** Immediately.
- 3.2. Develop strategies to assist Zones to establish their own Medical Commissions (e.g., European Medical Commission) to coordinate work from Zonal to World level. **Implementation:** As soon as possible.

4. t33 rule and withdrawal from competition

- 4.1. Investigate the components of t33 rule to determine whether changing treatment time from 10 down to 5 minutes is warranted. **Implementation:** 2016 Cadet/Junior World C'ship.
 - 4.1.1. According to the existing t33 rule, 10 minutes is the **maximum** time allowed for **treatment** to be completed so the med delegate can and should inform the referee that the fight can re-start after any number of minutes, up to 10, according to the need for treatment. There is apparently a misconception amongst some officials that the fencer can decide.

- 4.2. To request ComEx to ensure that any withdrawal at a competition for a *medical reason* is authorized by a medical professional, with documentation. The DT cannot authorize such an action. **Implementation:** Beginning of 2016 season.
- 4.3. To request ComEx to investigate and develop protocol to deal with fencers who withdraw from competition for *political reasons*. **Implementation:** Immediately.
- 5. Juniors, Veterans, Transgender issues**
- 5.1. Establish protocol for all participants in Cadet/Junior World C'ships to complete the recommended on-line anti-doping education program. **Implementation:** Beginning for 2016 Junior/Cadet World C'ship.
- 5.2. Coordinate with Veterans Council to establish:
- 5.2.1. injury surveillance systems for veterans competitions,
- 5.2.2. educational resources on medical and health costs/benefits of fencing in older adults,
- 5.2.3. provide anti-doping education and guidance.
- Implementation:** As soon as possible.
- 5.3. Develop protocol to confirm adherence to IOC regulations for transgender athletes. **Implementation:** Immediately.
- 6. Safety issues**
- 6.1. Coordinate with SEMI re: safety of raised pistes, especially consideration of the width. **Implementation:** Immediately.
- 6.2. Recommendation that Supervisor responsibilities include direction to remind referees to check that each fencer's masks are well fitting. Request Referee Commission to also implement this action for its members. **Implementation:** Beginning of 2015-16 season.
- 6.3. Work with ComEx to establish a mechanism for a Medical Commission member to be involved in the investigation of any fencing-related fatalities or catastrophic injuries. **Implementation:** Immediately.
- 7. Injury prevention and athletes health care**
- 7.1. Investigate the legal and insurance viability of an International Medical Task Force (IMTF) to provide adequate care and assistance to all fencers competing in FIE World Championships. **Implementation:** 2015-16 season.
- 7.1.1. FIMS meeting in October will include the topic of doctors travelling to sports events abroad.
- 8. Injury reporting**
- 8.1. Coordinate with Sports Director to ensure that organizers and event management software developers use a standard code in event results for athletes (F = did not participate; A = left competition for medical reason (illness; injury); E = left competition for technical reason (e.g., black card). **Implementation:** Immediately.
- 8.2. Arrange a system for national federations to report severe or fatal fencing-specific injuries (i.e., lacerations; penetrations). **Implementation:** Beginning 2016.
- 8.3. Coordinate with FIE Webmaster to ensure that the Supervisor reports contain the appropriate documentation to report details of athletes leaving competition for medical reasons (refer to 18). **Implementation:** As soon as possible.
- 9. Other**
- 9.1. Begin preliminary planning for Medical Conference at 2017 World C'ships in Leipzig. **Implementation:** Immediately.
- 9.2. Add Medical section/educational information for FIE Continental Coaches Seminars. **Implementation:** Beginning 2016.
- 9.3. Coordinate with FIE Webmaster to improve navigation of FIE website, especially for access to Medical Commission documents, and to improve content up-load (e.g., Sports medicine articles from *Escrime*). **Implementation:** As soon as possible.

Administrative Issues

- 1) The following delegate assignments are recommended to ComEx:
 - a) 2016 Cadet & Junior World C'ships – Daly (TUN); Harmer (AUS)
 - b) 2016 Team World C'ships – Defoligny-Renault (FRA)
 - c) 2016 Veterans World C'ships – Halsted (GBR) (Reserve: Mourad (EGY)

- 2) On July 31, Nathalie Rodriguez visited to explain the decision of the Executive Committee to not accept the recommendation of the Medical Commission delegates to the Olympic Games.

Inter-Commissions Meetings Recommendations

- A. **Medical – SEMI** (Halsted, Rodriguez-Rey, Wolfgarten)
- a) We suggested a worldwide injury reporting system under the Medical and SEMI Commissions supervision in case of severe injuries.
 - b) We agreed that the Medical Commission will make a proposal with an exact definition of the design of plastrons—address partner from SEMI: Mir. Daniel Dechaine.
 - c) We proposed an evaluation of the results of the new gloves.
 - d) We expressed our worry about new until now not reported sabre accidents caused by broken blades with perforation of the clothing (vest and plastron)
 - e) We expressed our concerns about the height and width of the current final piste. SEMI Commission is already discussing this item. They agree that the height of the piste should be reduced for safety reasons while not losing visibility. However, to accommodate the LED panels with the names and the scores, as well as the clock, still requires a minimum height of around 30 cm.
 - f) We discussed the ideas/proposals of the SEMI Commission about improvement of the safety in sabre fencing (new steel, new tips, change of the blocking time, change of the flexibility, efforts to reintroduce new constructed captors).
- B. **Medical – Veterans Council** (Fiore, Harmer, Halsted, van Dugteren)
- a) In conference with Veterans Council, we agreed on projects to assist with the goals of the Council.
- C. **Medical – Women’s Council** (Fiore, Halsted, Mourad)
- a) They explained the proposal for a new Safe Sport policy for the FIE—to tie in with the Ethics Policy coming from the Legal Commission when dealing with the issue of misconduct (sexual, emotional, physical, harassment of any sort), especially where minors are concerned.
 - b) They aim to have clear policies with consequences and raise awareness through providing information and training material. Our support was requested and given.
- D. **Medical – Rules Commission** (Dali, Fiore, Kamuti)
- a) Change of the t33 Rule from reduction in the maximum time-out for medical reason from 10 to 5 minutes.
 - i) Well aware that the current time of ten minutes represents only a maximum, not an automatic condition for on the spot treatment of the athlete, it is almost impossible for the attending physician on the strip during competition to objectively assess when the fencer can resume the bout by forcing him to use less than the maximum ten minutes currently in the Rules.
 - ii) In addition considering the fact that a fencer may simulate being injured and/or in pain, a shorter break reduces the problem of too long down time, inducing the athlete to speed up the treatment he is receiving to avoid being eliminated after five minutes.
 - iii) Lastly, most and most frequent incidents in fencing can be handled in five minutes, i.e., wrapping or taping of the ankle or the knee for not serious sprains, or with the simple icing for trauma.
 - iv) OTOH, more serious injuries, lumbago, sprained or twisted knee, shoulder dislocation, muscular lesion, or cramps are pathologies for which ten minutes are not enough to resume the bout in ideal conditions.
 - v) The Rules Commission is very interested in the possibility to change t33 Rule and underscored the importance to define the exact moment when the clock starts ticking for the allotted time. Currently the rule states that the clock can start ticking only after the medical delegate grants the time. Quite often, especially in the preliminary phases of the major competitions several minutes go by before the medical delegate arrives on the spot. This means that in case of injury break the time is quite longer than the ten minutes (the total time is difficult to quantify). During finals this problem is substantially reduce since the medical delegate is usually near the strip(s). So the delay in starting the clock from when the athlete communicates to the referee his injury and the time the medical delegate can be at the piste and make a decision to activate the clock is very short.
 - vi) We discussed the merit of evaluating this change in the rule during a test event, for example at the next Cadet/Junior World Championships. The Rules Commission confirmed its agreement to change the rule as an experiment during one competition to evaluate the impact on the flow of the competition.
 - b) The medical delegate to have the authority to stop directly the bout
 - i) This would require a change in the Rules by granting the medical delegate to stop the bout in any situation where the athlete’s health is at risk.
 - ii) This require an in depth analysis and study considering that FIE medical delegates are present in few competitions. Most of the time the only physician on the spot is provided by the LOC who may not be professionally prepared and competent to take such a delicate and complex decision.

Attached: PROPOSALS document (link: <http://admin.fie.org/member/meeting/document>)

Submitted: August 6, 2015

PROPOSALS SUBMITTED TO THE MEDICAL COMMISSION 2015 CONGRESS

MODIFICATIONS OF THE STATUTES

Proposals of the Executive Committee

Proposals of the Medical Commission

Proposal 1

It is proposed that the following text be added to the FIE Statutes:

6.8 ANTI-DOPING PANEL

At an Elective Congress, if persons with adequate experience and competence in anti-doping are elected to the Medical Commission, the FIE anti-doping program remains the responsibility of the Medical Commission;

But in the event that not enough persons with adequate experience and competence in anti-doping are elected, the FIE Executive may, in consultation with the Medical Commission, appoint a small Anti-Doping Panel (consisting of between 3 and 5 persons) to take responsibility for leading the FIE anti-doping program.

Motivation:

As with all International Federations, the FIE is obliged to continue with its professional approach to the problem of doping. Even though Fencing is widely regarded as a relatively 'clean' sport, we need to keep it that way by continuing with our comprehensive anti-doping program, as required by the revised 2015 World Anti-Doping Code, and as described in our 2015 FIE Anti-Doping Rules.

We are very satisfied with the administrative work done on behalf of the FIE by the Doping-Free Sport Unit (DFSU) of *SportAccord*, but the FIE must continue to take legal and moral responsibility for directing our sport's anti-doping strategy, and for managing those important aspects of our anti-doping program that cannot be left to the DFSU.

Until now, we have relied on certain members of our Medical Commission who have the required experience in anti-doping matters to act as an "Anti-Doping Commission" and provide the leadership and expertise needed to ensure the proper running of our anti-doping program.

But in view of the fact that the members of FIE Commissions are elected, there is no guarantee that the new members who will be elected to the Medical Commission in 2016 will have the required anti-doping experience.

This potential problem can be best resolved by the proposed modification of the Statutes.

Proposals of the Legal, Medical and PP Commissions and Women and Fencing Council

Proposal:

That the minimum representation of men and women on the FIE Executive Committee and all FIE Commissions and Councils should be raised from 20% to 30%.

Rationale:

In 2007 the Olympic Charter was amended to include, for the first time in history, the following:

"The IOC encourages and supports the promotion of women in sport at all levels and in all structures, with a view to implementing the principle of equality of men and women." □ Rule 2, paragraph 7, Olympic Charter in force as from 07.07.2007

The International Olympic Committee (IOC) has publically committed itself to increasing the number of women occupying leadership positions within the Olympic Movement. Twelve years ago, in 2003, the FIE Congress took the decision to require minimum representation of 20% of men and women on the FIE Executive Committee and all FIE Commission.

In line with the commitment of the IOC and best practice in organisational governance, it is now time to increase gender balance in the FIE by increasing the minimum representation of men and women on all FIE Commissions and Councils to 30%.

Proposed changes to FIE Statutes:**Proposal 1**

4.3.4: In order to secure the principle of equal treatment, women and men must be represented in overall view by at least ~~20~~ 30% of the elected members of the Executive Committee. If the 15 candidates who have obtained the most votes do not include at least ~~3~~ 5 persons of each gender, the Executive Committee will consist of the ~~3~~ 5 candidates for the Executive Committee who have obtained the greatest number of votes of the gender not otherwise being so represented and the ~~12~~ 10 candidates of the other gender who have obtained the greatest number of votes.

If there are less than ~~3~~ 5 candidates of either gender, that gender will be represented by the number of candidates put forward and the remainder of the Executive Committee will consist of the candidates of the other gender who have obtained the most votes.

Proposal 2

4.4.4: If the 10 first members elected do not include ~~two~~ 3 members of each gender, the Commission will consist of the first ~~8~~ 7 members elected and the ~~two~~ 3 members of the other gender who are candidates for the commission and who have obtained the greatest number of votes. If no candidate of either gender has offered herself/himself as candidates, the 10 candidates of different nationalities with the greatest number of votes are elected.

MODIFICATIONS TO THE RULES

Proposals of the Executive Committee

Proposal 10

Motivation: During the last two seasons, there have been several incidents involving masks which failed to properly secure the position of the mask on the fencer's head, in violation of the standard included in Annex 2.2.4 and of the urgent letter of the Executive Committee # 14 of 15 July 2014. The following modifications are therefore proposed, as well as the correction of a typing error in the French text.

m. 25.7 MASK:

- a) The **mask** must be made with meshes (space between the wires) of maximum 2.1 mm and from wires with a minimum gauge of 1 mm diameter. The mask must include ~~a safety strap at the rear~~ **two different safety systems at the rear.**
- f) The mask must contain ~~a horizontal safety strap~~ **two different safety systems at the rear of the mask, with the two ends of ~~the strap~~ the straps of the systems firmly affixed to the two sides of the mask. ~~This strap may~~ These straps may be elastic or of any other material that is approved by ~~the~~ the S.E.M.I. Commission.**

Please refer to the examples in the drawings below:

These images are only provided for information. When in doubt, the wording of the relevant text shall prevail.

EQUIPMENT

2. STANDARDS FOR THE MANUFACTURING OF MASKS

2.2

4 - Essential constituent elements

In particular, ~~the rear fixing device must ensure~~ **the rear fixing devices must** make sure that the mask is located in the correct position on the fencer's head and that it remains in a perfect position, even after blows or shocks.

Application as follows: 1st of January 2016

PROPOSALS SUBMITTED TO THE MEDICAL COMMISSION 2015 CONGRESS

MODIFICATIONS OF THE STATUTES Proposals of the Executive Committee

Proposals of the Medical Commission

Proposal 1

It is proposed that the following text be added to the FIE Statutes:

6.8 ANTI-DOPING PANEL

At an Elective Congress, if persons with adequate experience and competence in anti-doping are elected to the Medical Commission, the FIE anti-doping program remains the responsibility of the Medical Commission;

But in the event that not enough persons with adequate experience and competence in anti-doping are elected, the FIE Executive may, in consultation with the Medical Commission, appoint a small Anti-Doping Panel (consisting of between 3 and 5 persons) to take responsibility for leading the FIE anti-doping program.

Motivation:

As with all International Federations, the FIE is obliged to continue with its professional approach to the problem of doping. Even though Fencing is widely regarded as a relatively 'clean' sport, we need to keep it that way by continuing with our comprehensive anti-doping program, as required by the revised 2015 World Anti-Doping Code, and as described in our 2015 FIE Anti-Doping Rules.

We are very satisfied with the administrative work done on behalf of the FIE by the Doping-Free Sport Unit (DFSU) of *SportAccord*, but the FIE must continue to take legal and moral responsibility for directing our sport's anti-doping strategy, and for managing those important aspects of our anti-doping program that cannot be left to the DFSU.

Until now, we have relied on certain members of our Medical Commission who have the required experience in anti-doping matters to act as an "Anti-Doping Commission" and provide the leadership and expertise needed to ensure the proper running of our anti-doping program.

But in view of the fact that the members of FIE Commissions are elected, there is no guarantee that the new members who will be elected to the Medical Commission in 2016 will have the required anti-doping experience.

This potential problem can be best resolved by the proposed modification of the Statutes.

Opinion of the Medical Commission: In favour as modified.

The Medical Commission will appoint an anti-doping panel of not less than 3 persons, whose members shall come from the Medical Commission. However, if there are insufficient members with adequate experience in anti-doping matters, the Medical Commission will recruit person(s) from outside of the Medical Commission, which person(s) shall require the approval of the Executive Committee.

Proposals of the Legal, Medical and PP Commissions and Women and Fencing Council

Proposal:

That the minimum representation of men and women on the FIE Executive Committee and all FIE Commissions and Councils should be raised from 20% to 30%.

Rationale:

In 2007 the Olympic Charter was amended to include, for the first time in history, the following:

"The IOC encourages and supports the promotion of women in sport at all levels and in all structures, with a view to implementing the principle of equality of men and women."
Rule 2, paragraph 7, Olympic Charter in force as from 07.07.2007

The International Olympic Committee (IOC) has publically committed itself to increasing the number of women occupying leadership positions within the Olympic Movement. Twelve years ago, in 2003, the FIE Congress took the decision to require minimum representation of 20% of men and women on the FIE Executive Committee and all FIE Commission.

In line with the commitment of the IOC and best practice in organisational governance, it is now time to increase gender balance in the FIE by increasing the minimum representation of men and women on all FIE Commissions and Councils to 30%.

Proposed changes to FIE Statutes:

Proposal 1

4.3.4: In order to secure the principle of equal treatment, women and men must be represented in overall view by at least ~~20~~ 30% of the elected members of the Executive Committee. If the 15 candidates who have obtained the most votes do not include at least ~~3~~ 5 persons of each gender, the Executive Committee will consist of the ~~3~~ 5 candidates for the Executive Committee who have obtained the greatest number of votes of the gender not otherwise being so represented and the ~~12~~ 10 candidates of the other gender who have obtained the greatest number of votes.

If there are less than ~~3~~ 5 candidates of either gender, that gender will be represented by the number of candidates put forward and the remainder of the Executive Committee will consist of the candidates of the other gender who have obtained the most votes.

Opinion of the Medical Commission: In favour.

Proposal 2

4.4.4: If the 10 first members elected do not include ~~two~~ 3 members of each gender, the Commission will consist of the first ~~8~~ 7 members elected and the ~~two~~ 3 members of the other gender who are candidates for the commission and who have obtained the greatest number of votes. If no candidate of either gender has offered herself/himself as candidates, the 10 candidates of different nationalities with the greatest number of votes are elected.

Opinion of the Medical Commission: In favour.

MODIFICATIONS TO THE RULES Proposals of the Executive Committee

Proposal 10

Motivation: During the last two seasons, there have been several incidents involving masks which failed to properly secure the position of the mask on the fencer's head, in violation of the standard included in Annex 2.2.4 and of the urgent letter of the Executive Committee # 14 of 15 July 2014. The following modifications are therefore proposed, as well as the correction of a typing error in the French text.

m. 25.7 MASK:

- a) The **mask** must be made with meshes (space between the wires) of maximum 2.1 mm and from wires with a minimum gauge of 1 mm diameter. The mask must include ~~a safety strap at the rear~~ two different safety systems at the rear.
- f) The mask must contain ~~a horizontal safety strap~~ two different safety systems at the rear of the mask, with the two ends of ~~the strap~~ the straps of the systems firmly affixed to the two sides of the mask. ~~This strap may~~ These straps may be elastic or of any other material that is approved by ~~the~~ the S.E.M.I. Commission.

Please refer to the examples in the drawings below:

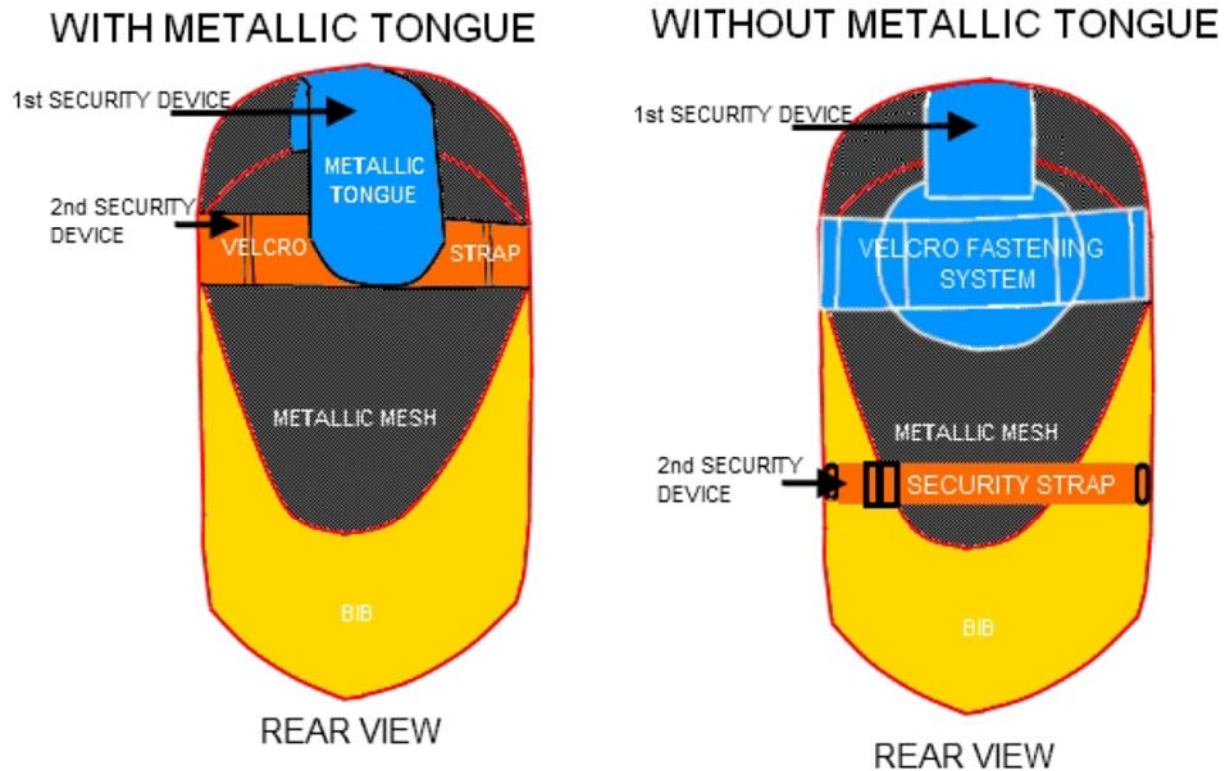

These images are only provided for information. When in doubt, the wording of the relevant text shall prevail.

EQUIPMENT

2. STANDARDS FOR THE MANUFACTURING OF MASKS

2.2

4 - Essential constituent elements

In particular, ~~the rear fixing device must ensure~~ the rear fixing devices must make sure that the mask is located in the correct position on the fencer's head and that it remains in a perfect position, even after blows or shocks.

Application as follows: 1st of January 2016

Opinion of the Medical Commission: In favour.

AGENDA

Day 1: 30 July, 2015

9.30 [Plenary session](#)

11.15.1 Presentation and adoption of the agenda

Presentation by the members of the CMTV

- The road to RIO 2016 Asimina
- TV Production and distribution Barna
- The new FIE website Marina

Study of proposals to Congress

[Leon Paul's presentation on wireless face lights](#)

Progress reports on the actions and proposals made by the PP commission during the last meeting

- Proposals to COMEX
- Actions items
- Change of name of the commission, Amendment of the statutes?

Day 2 : 31st July 2015

Progress report (continued)

- 16:00 Meeting with Veteran's Commission
17: 00 Meeting with Women's Council

Day 3 : August 1st, 2015

- 9.30 Writing of proposals and Minutes of the meeting
14 :30 Plenary session



Commission Promotion.

Minutes of the Meeting 30th, 31th July and 1st August 2015 Hotel Crown Plaza, Bucarest ROU

Present:

Ms Cécile FAYE (SEN) President
Mr Donald K. ANTHONY Jr (USA) representative COMEX
Mr Ali Abderrahman BELHAHJ (TUN) Member
Mr Carl BORACK (USA) Member
Ms Elena GRISHINA (RUS) Member
Mr Victor Sergio GROUPIERRE (ARG) Member
Mr Reno MAROLT (CRO) Member
Mr Nikolay Ivanov MATEEV (ISL) Member
Mr Rigoberto MOREJON LLANES (CUB) Member
Ms Hilary PHILBIN (GBR) Member
Mr Gianandrea NICOLAI (ITA) Member and Secretary of the Meeting

Also present:

Ms Nathalie RODRIGUEZ (FIE-FRA) CEO
Mr Krisztian KULCSAR (FIE-HUN) Sport Department Director
Ms Asimina TSELLOU (FIE-GRE) Media Manager
Ms Maria Ntanou (FIE-HUN) Media Coordinator
Ms Marina Shturbabina (FIE-UKR) IT Manager
Mr Barna Heder (FIE-HUN) Head of FIE Television Production

1. Plenary Session.

The Plenary Session began at h 9:30 in Crown Meeting Room with all Commissions and Councils. Ana Pascu (MH-ROM), FIE Vice President, and Nathalie Rodriguez, FIE CEO opened the day and gave welcome in Romania.

2. Welcome and Foreword by the President of the FIE`s Commission P. & P.

The Chairman Cécile Faye opened the Meeting of the PP Commission at h 11.00 and thanked all PP Commission Members.

3. Presentation and Validation of the Agenda.

The Members of the Commission listened from the President the Agenda and they approved the proposed content and times.

4. Presentation by the members of the CMTV

Asimina Tsellou introduced the members of the CMTV and presented some material and activities done for the Project “The road to Rio 2016”.

Marina Shtubarbina explained all activities done to promote and develop the FIE website.

Barna Heder explained what FIE did and his work on TV Production and distribution including during the World championships and Grand Prix series.

Members of the PP Commission addressed many questions and all the topics covered by CMTV are discussed in depth.

5. Proposal for the amendments of rules and of Statutes.

The Promotion Commission analyzed and discussed the proposals received. The final document is attached. (Attached A)

6. Leon Paul and the new Aurora Mask Lighting.

Mr Ben Paul, Director in Leon Paul – London showed a prototype for a new mask “Aurora Mask Lighting”, using lights inside the mask to illuminate the face. And he presented a new Wireless Fencing system for warm up and some competitions; this new wireless system include a base station and fencer packs.

Both products, Wireless and Aurora mask, can work together.

The presentation was well received and we are waiting for homologation.

7. Proposal from P&P Commission to FIE COMEX.

Hilary Philbin read the PP Commission document written during last Meeting in Lausanne July 2014 and sent to FIE COMEX. The Promotion Commission comments and updates all proposals.

The PP Commission selects priority proposals and added four new proposals, all with high priority. (Attached B)

8. Fencing Uniform Project.

Nathalie Rodriguez explained the discussions she had with Ecole Polytechnique de Lausanne. A meeting with a Working Group with Medical and SEMI Commissions and Manufacturers of fencing equipment will be planned in Lausanne, about clothes and materials. Some researches in nanotechnology are being done at the moment, but we don't know costs and times. The Fencing Uniform Project will involve not only design, but safety issues.

9. Proposals from PP Commission to Comex.

Nathalie Rodriguez explained the best way and how to send proposals to Comex from PP Commission.

For each proposal we need to give priority, to describe benefits, who are the persons involved, costs and a general planning.

10. Meeting with Veterans Council

The Veteran Council welcomed the PP Commission and the President Mr Francis Yat Ping Kwong (SIN) described the activities of the Veterans. An initiative of the medium term, as evidenced by the presentation of Mr Max Geuter (MH - GER), Comex Representative in Veterans Council, is the proposal to change the name "Veterans" in "Seniorplus". They believe the new name could favor the approach of potential sponsors. The name "Veteran" evokes the memory of wars, while the word "Senior" is associated with people with a good income and that are the subject of specific market sector.

11. Meeting with Woman and Fencing Council.

The Women and Fencing Council welcomed the PP Commission. The President of the Women Council Ms Stacey Johnson (USA) and the President of the Oceanian Fencing Confederation Ms Helen Smith (MH – AUS) explained their functions: to increase the number of initiatives to encourage more women to participate in fencing, both as fencers and in the management of the sport, to encourage the organisation of training courses for women in the different areas of sport (leadership, management, supervisory staff, training, refereeing), to ensure equal opportunities in the management and participation of women and their representation in sport, to encourage women to work and contribute to the development of fencing throughout the world at all levels.

Ms Georgina Usher GBR presented a research carried out in England between girls and boys from 15 to 24 who practice fencing.

The PP Commission confirmed that they had always supported the initiatives of the Woman and Fencing Council and that today and in the future will support the Women Council. For the inclusion of more women in technical commissions such as referees

and SEMI, the PP Commission had proposed the organisation of special training sessions for them.

12. Presentation of possible use of tracking.

Donald K. Anthony Jr presented a brief report on tracking, a project carried out by the Company **Zebra Technologies Corporation** - Corporate & International Headquarters - 3 Overlook Point - Lincolnshire, Illinois 60069 USA. Part of this products and applications were used during some American Fencing Championships. This system has great potential and short-term may be tested for further applications in the world of fencing.

www.zebra.com/us/en/solutions/location-solutions/sports-tracking.html.

13. Meeting with the representative of the Athletes' commission.

The PP commission welcomed Mr Paris Inostroza Budinich (CHI), who listened and participated in the updating of the document on the proposals to be sent to the Comex.

14. Plenary Session and closing of the Meeting.

Nathalie Rodriguez opened the Plenary Session and thanked Ms Ana Pascu, the President of the Romanian Fencing Federation Mr Mihai Covaliu, the FIE staff, and then all the participants of the Commissions and Councils.

She then introduced the Presidents of the Commissions and Councils and invited them to submit their proposals to the Plenary Session.

Ms Stacey Johnson (USA) for Women and Fencing Council began the presentations, followed then by Mr Gennady Tyshler (RSA) for Couches Council, Mr Francis Wong Yat Ping (IND) for Veterans Council, Mr Paris Inostroza Budinich (CHI) for Commission of Athletes, Mr Claus Janda Klaus (GER) for Refereeing Commission, Mr Samuel David Chervis (USA) for Legal Commission, Mr Antonio Fiore (ITA) for Medical Commission, Ms Cecile Faye (SEN) for Promotion Commission, Mr. Giuseppe Cafiero (ITA) for Rules Commission, Mr. Semen Rikhtman (RUS) for SEMI Commission.

Ms Hilary Philbin (GBR – PP Commission), also on behalf of all participants, thanked Nathalie Rodriguez for the great organizational work done and Ana Pascu for the warm and efficient welcome received from the Romanian Fencing Federation.

Plenary Session was closed by Mr Donald (USA - FIE Comex and PP Commission) who introduced a new movie written and directed by Mr Carl Borack (USA – FIE PP Commission) called “A path to excellence”, about PWF – Peter Westbrook Foundation, a not-for-profit organization that uses the sport of fencing to develop life skills in young people from underserved communities throughout the New York metropolitan area.

This film by Carl Borack has many interviews and a completely story of the Club and its mission.

The President of the PP Commission
Cécile Faye

The Secretary of the Meeting
Gianandrea Nicolai

**PROPOSALS SUBMITTED TO THE PROMOTION COMMISSION
2015 CONGRESS**

**MODIFICATIONS OF THE STATUTES
Proposals of the Executive Committee**

Proposal 3

Motivation: The current entry fee is too low and has not changed for years, although the costs of the organizers have been increasing.

6.2 Amounts to be paid to the organizers:

Subjet	Euros
Entry fee junior A grade tournament	15 25

Proposal 4

Motivation: Any competition organization should be subject to payment of an entry fee. It is not normal that an organizer perceives nothing in return for hosting a competition.

6.2 Amounts to be paid to the organizers:

Subjet	Euros
Entry fee junior team tournament	100

IN FAVOUR

Proposals of the Legal, Medical and PP Commissions and Women and Fencing Council

Proposal:

That the minimum representation of men and women on the FIE Executive Committee and all FIE Commissions and Councils should be raised from 20% to 30%.

Rationale:

In 2007 the Olympic Charter was amended to include, for the first time in history, the following:

"The IOC encourages and supports the promotion of women in sport at all levels and in all structures, with a view to implementing the principle of equality of men and women."
Rule 2, paragraph 7, Olympic Charter in force as from 07.07.2007

The International Olympic Committee (IOC) has publically committed itself to increasing the number of women occupying leadership positions within the Olympic Movement. Twelve years ago, in 2003, the FIE Congress took the decision to require minimum representation of 20% of men and women on the FIE Executive Committee and all FIE Commission.

In line with the commitment of the IOC and best practice in organisational governance, it is now time to increase gender balance in the FIE by increasing the minimum representation of men and women on all FIE Commissions and Councils to 30%.

Proposed changes to FIE Statutes:

Proposal 1

4.3.4: In order to secure the principle of equal treatment, women and men must be represented in overall view by at least ~~20~~ 30% of the elected members of the Executive Committee. If the 15 candidates who have obtained the most votes do not include at least ~~3~~ 5 persons of each gender, the Executive Committee will consist of the ~~3~~ 5 candidates for the Executive Committee who have obtained the greatest number of votes of the gender not otherwise being so represented and the ~~12~~ 10 candidates of the other gender who have obtained the greatest number of votes.

If there are less than ~~3~~ 5 candidates of either gender, that gender will be represented by the number of candidates put forward and the remainder of the Executive Committee will consist of the candidates of the other gender who have obtained the most votes.

Proposal 2

4.4.4: If the 10 first members elected do not include ~~two~~ 3 members of each gender, the Commission will consist of the first ~~8~~ 7 members elected and the ~~two~~ 3 members of the other gender who are candidates for the commission and who have obtained the greatest number of votes. If no candidate of either gender has offered herself/himself as candidates, the 10 candidates of different nationalities with the greatest number of votes are elected.

IN FAVOUR

PROPOSALS SUBMITTED TO THE PROMOTION COMMISSION 2015 CONGRESS

MODIFICATIONS TO THE RULES Proposals of the Executive Committee

Proposal 1

p.10 Position and sizes

- 1 The articles of the fencers' **equipment** may carry the following visible marks:
 - a) **mask**: one mark on the rear of the spring. Maximum size: ~~6 x 5.5 cm~~ 12.5 cm².
 - b) **jacket**: one mark at the bottom of the jacket on the hip on the side of the non-sword arm. Maximum size: ~~4.5 x 2 cm~~ 30 cm².
 - c) ~~breeches~~ trousers: one mark at the bottom ~~of the breeches of the trousers~~, on one side only. Maximum size: ~~4.5 x 2 cm~~ 30 cm².
 - d) **stockings socks**: one mark on each ~~stocking sock~~. ~~in size 4.5 x 2 cm~~. Maximum size: 10 cm².
 - e) **shoes**: the name of the brand on each shoe. Maximum size: ~~4.5 x 2 cm~~ 10 cm² or the usual logos (e.g.: bands).
 - f) **glove**: ~~no mark~~. One mark: maximum size: 10 cm². If the mark is affixed on the glove with the help of a label (glued or sewn), the latter must be placed on the cuff.
 - g) **weapon**: ~~no mark visible at a distance~~. ~~One mark~~. Maximum size: 2.5 cm².
 - h) **electric jacket**: one mark at the bottom of the jacket on the hip of the side of the non-sword arm. Maximum size: 30 cm².

Application as follows: 1st of January 2016

IN FAVOUR

Proposal 2

Motivation: Allowing fencers to take advantage of potential sponsors.

p.12

2 Fencing clothing and equipment

- a) If a federation and/or a fencer have signed a **sponsorship contract** with a commercial or other company, the logo of that sponsorship partner, maximum 125 cm² in size, may be affixed at the top of the sleeve of the fencing jacket (non-sword arm), on the side of the trousers (left or right), or on the socks. At sabre, a logo may not be worn on the sleeve.

The sponsor(s) logo may be displayed on each side of the mask. Maximum size: 100 cm² on each side of the mask.

- b) The **number of logos** shall not exceed ~~four~~ five. The **total surface** of all logos added together may not exceed a total of 500 square centimetres.

Application as follows: 1st of January 2016

IN FAVOUR

Proposal 3

Motivation: The following is no longer part of common practice. Furthermore, it may provoke conflicts with the sponsors of athletes or federations. Therefore, the proposal is to remove the following articles from the Publicity Code:

~~p.12.5.b) As far as possible, the **organisers** must make it clear, in the conditions of entry for the competition, the way in which advertising material worn or carried by the fencers will be permitted.~~

~~LEG-BAND OR SELF-ADHESIVE NOTICE~~

~~p.13~~

~~1 Principles~~

~~a) The organisers of a competition may identify the fencers by issuing them with a number on a **leg-band** or on a **self-adhesive badge**.~~

~~b) In such a case, the wearing of this **band** or **badge** is obligatory for the fencers.~~

~~c) The **self-adhesive badge** must be of a rough material which will not cause the point to slip.~~

~~d) The **leg-band** or **self-adhesive badge** may have on it advertising material within the limitations of the rules below.~~

~~e) The **circular** announcing the details of the competition must make clear what bands or badges the fencers are to wear, and what publicity will be on them.~~

~~Entering the competition implies an acceptance by the fencer of the obligation to wear the band or badge in question.~~

~~2 Position and size~~

~~a) The **leg-band** must be fixed to the thigh on the side of the non-sword arm. The maximum **size** of the leg-band is of 20 x 20 cm. The fencer's number must be at least 10 cm high and 15 cm in width.~~

~~b) The **self-adhesive badges** must be fixed to both sides of the mask, on the side mesh.~~

~~The maximum **size** of the badges must be 10 cm wide by 15 cm high. The fencer's number must be no more than 8 cm high by 8 cm wide. At foil and épée only the self-adhesive badge of the competition taking place must be worn.~~

~~c) In both cases, **the advertising**, words or badge, must be placed below the number and must not exceed 35 mm in height.~~

~~d) If the self-adhesive badge on the mask **does not include a number**, it may only be used for advertising following agreement with the FIE.~~

Application as follows: 1st of January 2016

IN FAVOUR

Proposal 9

Motivation: Clarification of the text in order to avoid incidents due to the interpretation of the rules.

General conditions

m.25

The national uniform includes the socks, the trousers, the jacket, and the conductive jacket at foil and sabre. (Cf. m.28, m.34).

3 CHARACTERISTICS OF THE CLOTHING:

- e) **There shall be only one national uniform per country, with the exception of the manufacturer's mark and the logo of the sponsors.**

Application as follows: 1st of January 2016

IN FAVOUR

Deferred Proposals

1. Deferred proposal of the Hungarian Fencing Federation

Motivation:

It is merely a clarification of an existing rule, more precisely that the fencer must not be penalised by one meter unless he crosses the lateral boundaries of the piste with two feet.

t. 17.9

The return on guard, at a distance, for a **lateral exit of the two feet** may place the opponent committing the error on the other side of the rear line and lead to a hit.

Opinion of the working group 2015 (Rules, Refereeing, Promotion Commissions, Coaches Council, Athletes Commission) in charge of reviewing the proposal deferred in 2014:

The text proposed by the Rules Commission in English is preferable, but the English text will have to be adapted for application in French. The new French text proposed is the following:

Approved with amendment

If a fencer completely crosses the lateral boundaries of the piste, with one or two feet, he must be placed on guard at the correct distance, even if this means that he is placed behind the rear line and causes a hit to be awarded against him. (cf t.28, t.102).

2. Deferred proposal of the Russian Fencing Federation

Motivation:

Reducing the number of simultaneous attacks for sabre. Increasing the number of actions in order to make matches more spectacular.

t.17.

1. For foil and épée, ~~the~~ **Referee places** each of the two competitors in such a way that the front foot of each is 2 metres from the centre line of the piste (that is, behind the 'on-guard' lines).

2. For sabre, the referee places each of the two competitors in such a way that the back foot of each is 2 m from the centre line of the piste (that is, in front of the "on-guard" lines).

Opinion of the working group 2015 (Rules, Refereeing, Promotion Commissions, Coaches Council, Athletes Commission) in charge of reviewing the proposal deferred in 2014:

The object of this proposal is to reduce simultaneous attacks at sabre. An ad hoc commission must be nominated by the Executive Committee as soon as possible, with the task to obtain statistics regarding simultaneous attacks during the rest of the 2015-16 season.

The working group is in favour of the proposal to organise tests, by introducing the rules proposed by the Russian Federation as temporary rules for all categories at sabre, men and women, during the period from the start of the 2016-2017 season until 31 December 2016.

The ad hoc commission will study the tests through comparisons with the statistics from the previous season. It will deliver its opinion at the end of 2016 to the Executive Committee, which will decide if the rule will be applied for the rest of the 2016-17 season.

The correct numbering of the articles in the proposal is t.17.2.a and t.17.2.b

NOT IN FAVOUR

3. Deferred proposal of the Swedish Fencing Federation

Adjustment of calculation procedure for individual and teams world ranking during the year following the Olympic Games (o.83 and o.84)

Motivation:

Participation in the Olympic Games is very limited. However, the multiplying factor for points attributed during the Olympic Games is of 3 for the individual competition and 2 for the teams competition (World Cup: 1; Grand Prix: 1.5; and World Championships: 2). This leads to an imbalance in the world rankings during the year following the Olympic Games, which is not corrected prior to the next World Championship, which can have even more lasting consequences on the ranking.

Opinion of the working group 2015 (Rules, Refereeing, Promotion Commissions, Coaches Council, Athletes Commission) in charge of reviewing the proposal deferred in 2014:

The working group recognises that there is a problem with the official FIE rankings during the season following the Olympic Games. In particular, in all Olympic teams competition participation is very low, which gives too much protection to participating teams and causes immobility in the rankings during the season following the Games.

The intention of the proposal formulated by the Swedish Federation to find a solution to this problem has also been mentioned by the Athletes Commission. However, the Athletes Council and the working group do not consider it appropriate to entirely cancel the results of the Games in the rankings of the new season.

The working group proposes that the multipliers be adjusted in order to reduce the consequences of the limited participation to the Games, and to improve the initial rankings of the competitions during the new season following the Olympic Games. The opinion of the working group is that the following multipliers are suitable:

The group proposes the following text in the Rules:

o.83.2 Individual ranking

b) The different competitions are attributed the following multipliers

Competition	Individual competitions
Olympic Games	2
World Championships	2
Grand Prix	1.5
Zonal Championships	1
World Cup	1

~~b) Points obtained in an individual A Grade World Cup competition have a multiplying factor of 4.~~

~~c) Points obtained in a Grand Prix competition of the FIE and a Zonal Championship are multiplied by a factor of 1.5.~~

~~d) Points obtained in the individual events of the Senior World Championships and in the Junior World Championships are multiplied by a factor of 2.5.~~

~~c) e) Points obtained in the individual events of the Olympic Games are multiplied by a factor of 3.0.~~ At the **Olympic Games**, the 4th is awarded ~~54~~ **36** points.

~~d) f)~~ Only fencers who have **actually participated** in a direct elimination table can receive any points.

IN FAVOUR

4. Deferred proposal of the Swedish Fencing Federation

o.84.2 Team scale of points

b) The different competitions are attributed the following multipliers

Competition	Multiplier
Olympic Games	1.5
World Championships	1.5
Zonal Championships	1
World Cup	1

~~b) For the World Team Championships, the points indicated above are multiplied by two.~~

~~c) Points obtained in a Zonal Team Championship have a factor of 1.0.~~

IN FAVOUR except two

5. Deferred proposal of the Swedish Fencing Federation

Creating a cycle for the Olympic programme, based on the principle of gender equality and equality between the different weapons (o.48.1)

Motivation:

The situation in which there are ten gold medals attributed to fencing at the Olympic Games continues since 2004, and there is no sign that the number of medals will increase. To this day, the Congress has taken decisions in what regards the Olympic programme three years in advance (for example, in November 2013 for the Olympic Games in Rio in 2016). It is clearly too late to allow athletes and national federations to prepare and plan their activities in a structured manner.

Consequently, it is desirable to clearly establish in our rules the Olympic programme cycle, in order to ensure stability and equity between the genders and the different weapons.

The Swedish Fencing Federation proposes the continuation of the cycle applied for the Olympic Games in Beijing, London, and Rio de Janeiro.

Opinion of the working group 2015 (Rules, Refereeing, Promotion Commissions, Coaches Council, Athletes Commission) in charge of reviewing the proposal deferred in 2014:

The working group is in favour of the proposal, but there seems to have been a misunderstanding concerning the structure of the proposed cycle. This proposal provides balance between the weapons and the genders in the current situation, even if it is very important to obtain two additional medals. The working group proposes the following cycle:

Programme of competitions

o.48

1. The programme of fencing events at the **Olympic Games** currently comprises 10 events. Given that the situation does not allow for organising 12 events, the programme of team events at the Olympic Games varies so that two weapons per team are not included during each Olympic year. For events not included in the Olympic programme, the FIE will organise World Championships.

The team competitions cycle at the Olympic Games will be:

Olympic Games 2016: Men's foil, men's épée, women's épée, women's sabre. (In the case of women's foil and men's sabre, the FIE will organise World Championships.)

Olympic Games 2020: Women's foil, men's épée, women's sabre, men's sabre. (In the case of men's foil and women's épée, the FIE will organise World Championships.)

Olympic Games 2024: Women's foil, men's foil, women's épée, men's sabre. (In the case of women's sabre and men's épée, the FIE will organise World Championships.)

The cycle described above is continued for the following Olympic Games (2028, 2032, ...)

Any change to the above cycle or to the number of events must be approved by the Congress.

IN FAVOUR

**FIE P&P COMMISSION
PROPOSALS - JULY 2015**

NEW PROPOSALS FROM P&P COMMISSION MEETING - JULY 2015		Priority	Owner	Next step	Date	Notes
1	For major events (World Championships and GPs) there should always be an MC, as well as announcers, to inform and entertain the live audience - particularly during short breaks and delays.	High	Hilary	Discuss with FP & KK	Next Sport Group mtg	
2	A video should be made, to be shown daily at the start of all major events, that informs the audience about how to watch a fencing bout.	High	Carl	Produce a proposal for Comex	For Sep-15 Comex	Not required, if access to film in point 7 below is obtained.
3	Set up a TV archive, available through a server, for professional use	High	Barna,Asimina & Maria	Produce a proposal for Comex	For Sep-15 Comex	Maria to look for tapes that were sent to Katrin in 2012
4	We recommend that an official photographer is sent to all zonal championships - Cecile to send email.	High	Cecile & Maria	Contact NR, FP & KK	sept.17	
CONTINUING PROPOSALS FROM P&P COMMISSION MEETING - JULY 2014		Priority	Owner	Next step	Date	Notes
4	We propose the introduction of athlete statistical and biographical information at major events, for live and TV audiences, and incorporating existing web data. This is because 60% of the decision-making by the IOC about our future in the Olympic Games is based on television audience (40%) and internet audience (20%). Data could include, for example, the track record between 2 fencers, their favourite hits, number of penalties, etc. Short biographical elements could be screened immediately before the start of finals fights, possibly including some footage from a previous bout. A reference could also come up on screen to show the FIE website. (Some questions are: what software is already available, if too costly how could it be done in a different way, and what do other sports do?)	High	Elena, with Asimina & Barna	Produce a proposal for Comex	For Nov-15 Comex	Could the graphics be produced by Tissot, when the timing is right? BH recommends that the graphics are in English only for the international feed, with other language versions being produced locally.
5	We propose the production of an announcer's kit for television and/or live streaming. We need to create the tools (for example, athlete 'quick reference' templates) that will help the announcers keep the audience informed and engaged. We also recommend the introduction of a short seminar for announcers, run by a professional sports announcer prior to major events.	High	Barna & Asimina	Produce a proposal for Comex	For Nov-15 Comex	BH's view is that the info is already available but the information needs to be packaged differently (eg - to show that an athlete has 3 Olympic medals, rather than searching through 3 sets of competition results). A proposal should go to Infostrada.
6	We propose that the FIE seeks permission from the IOC, via their TMS department, to allow us to produce a montage of historical Olympic fencing, to show at Rio 2016 before the events and during breaks.	High	Barna & Asimina	Clarify what limited usage is possible, and at what cost		
7	P&P would like to obtain from the IOC limited access to the fencing educational film (animated / motion capture) in use at London 2012 at the start of every session. AT agreed to follow this up with the IOC's TMS department and Barna will get feedback from OBS.	High	Barna & Asimina	Clarify what limited usage is possible, and at what cost		
8	We propose that the name of our Commission is changed to Promotion, Marketing & Development and that the statutes relating to the 'Duties of PP Commission' are updated to make them more meaningful to modern times.	Medium	Cecile	Submit a proposal for Congress, through the official route	avr.17	See separate sheet (next tab).
9	We propose that a film is made by joining together good fencing scenes from films (old and modern) for the entertainment of spectators in Rio. The rights would need to be cleared, but many old films are in the public domain.	Medium	Hilary	Seek info from Malcolm Fare	Before progress mtg in Nov-15	HP to obtain further info from Malcolm Fare about the film that he has already compiled
10	We propose that the FIE develops a programme similar to the USA's 'NFL Experience' (for example, called 'The Fencing Experience') so that spectators can try fencing at an event, meet an elite fencer, be escorted by an ambassador or buddy, and buy a t-shirt or souvenir from the FIE shop).	Medium				For more information see: wikipedia.org/wiki/National_Football_League_Experience
11	We would like to resubmit our 2013 proposal regarding the establishment of an elite fencers competition between zones, to be held in turn in each of the zones, with the best fencers in each weapon.	Low				
12	We propose the establishment of an FIE 'shop' at major events selling FIE fencing products. These could also be sold over the internet.	Low				
13	We propose, commencing in 2015, to have a display of historical fencing posters at the senior and junior world championships and Grand Prix competitions. (We can photograph the posters and reproduce them.)	Low				

**FIE P&P COMMISSION
PROPOSED AMENDMENT TO STATUTES - JULY 2015**

PROPOSED CHANGE TO THE NAME OF OUR COMMISSION

Current

PROMOTION & PUBLICITY

Proposed replacement

PROMOTION, MARKETING & DEVELOPMENT

PROPOSED CHANGES TO DUTIES OF OUR COMMISSION, AS LISTED IN THE FIE STATUTES

Current

The duty of this commission is:

- 1 to motivate and co-ordinate the activities of the member Federations for the promotion and development of fencing
- 2 to advise the Congress on the way in which the patronage of the FIE will be bestowed on international competitions
- 3 to propose the rules for the World cup competitions (A-category and Grand Prix) and Masters, and to supervise their application
- 4 and to maintain contact between the FIE and the fencing masters

Proposed replacement

The duties of this commission are:

- 1 to provide professional expertise to elevate and enhance the image of fencing for all groups including sponsors, audiences, fencers and all the fencing family
- 2 to propose innovations and improvements to COMEX, particularly those associated with television, internet and live audiences
- 3 to make recommendations to COMEX on all matters associated with promotion, marketing and development
- 4 to contribute to the continuing development of fencing in all zones
- 5 to propose changes and improvements to the sections in the administrative rules and handbooks relating to promotion, marketing and development

**FIE P&P COMMISSION
ACTION ITEMS - JULY 2015**

NEW ACTION ITEMS FROM P&P COMMISSION MEETING - JULY 2015		Owner	Timeframe	Notes
1	Cecile to identify African TV contacts and pass on to Barna, with a view to receiving highlights, eg - from the Doha GP event.	Cecile		
2	A P&P progress meeting is to be arranged during the Congress in November	Nikolay		
3	Dropbox to be set up for PP use for shared documents	Maria		
4	DA requested an implementation plan, showing when specific types of athlete data will be available through the FIE website.	Marina		
5	The current sponsor packs and contracts will be circulated via Dropbox.	Asimina		
6	The TV analysis and exposure analysis will be circulated via Dropbox..	Asimina		
7	The marketing plan and budget will be circulated via Dropbox.	Asimina		
8	The GP brand book and brochure will be circulated via Dropbox.	Asimina		
9	The list of TV channels that are entitled to broadcast will be circulated via Dropbox.	Asimina		
10	P&P are requesting the Rio 2016 ticketing info - Cecile to email Krisztian and Nathalie.	Cecile		
11	P&P would like to ask Rio 2016 if we can supply a display of historical fencing posters on the walls of the fencing venue - Cecile to email Krisztian.	Cecile		
CONTINUING ACTION ITEMS (WORKING PRACTICES) FROM P&P COMMISSION MEETING - JULY 2014		Owner	Timeframe	Notes
1	At each meeting produce a list of proposals and an action list with owners and dates - both lists to be finalised and agreed by the end of the meeting	Hilary	Ongoing	
2	Chase progress on P&P action list	Nikolay	Monthly	
3	P&P to send proposals after each meeting to Head Office & Comex	Cecile	2 wks after meeting	
4	DA to circulate P&P with relevant updates after each Comex meeting	Don	1 wk after each meeting	
5	P&P to add 'Progress Review' as first item on each meeting agenda	Cecile	Ongoing	
6	P&P to produce and agree minutes at the end of each meeting.	Gianandrea	Ongoing	
7	P&P to meet 3 times a year (without adding to the cost for the FIE) - the main meeting in Lausanne as usual plus 2 subsidiary meetings at the World Youth Champs and the Congress. (This will apply if there are at least 7 people present. DA will chair the meeting if CF is not able to be present.)	Cecile	Ongoing	
8	Asimina to be cc'd on any major emails circulated within P&P	All	Ongoing	

Minutes of the meeting of the Rules Commission

Place : Bucharest

Dates: 30 July – 1 August 2015

Present:

Ferial Salhi, Representative of the Executive Committee

Giuseppe Cafiero, President of the Commission

Members : Rusni Abu Hassan, Medhat El-Bakry, Manuel Belmonte, Ziad Feriani, Janine Lamon, Manuel Rondon Nieves, Lutz Schirrmacher, Pierre Thullberg

Invited : Stephen Higginson M-H

Part-time present : Krisztian Kulcsár, Nathalie Rodriguez

Excused : Jawir Adil

Agenda

- 1) Veteran rules proposal (Cafiero letters of April 21st and 24th),
- 2) Examination of proposal of rules modifications,
- 3) Progress of rules revision works,
- 4) Meetings with other Commissions (mainly Referees, Juridical, SEMI) – schedule to be defined by the General Secretary
- 5) Letter by the Secretary General concerning non-combativity, proposal of wording for an urgent decision
- 6) Length of the medical break, proposal of wording for an urgent decision
- 7) Consistency m.25 and t.45, proposal of wording for an urgent decision
- 8) Miscellaneous
 1. Proposals from the Iranian Federation
 2. Interpretation of o.43

1. Proposal of new veteran rules

To meet the deadline for proposals for the 2015 Congress, the President of the commission sent the proposal of the veteran's council (which does not have the right to present proposals) without the formal consent of the whole commission. This was an unfortunate situation and should be avoided. However, in this case, the proposal was later formally presented by the Executive Committee. The Commission unanimously stated its trust in the President to act in the interest of the Commission in situations of emergency.

2. Examination of proposals for the 2015 submitted to the Rules Commission

Statutes

Modifications of the Statutes, Proposals of the Executive Committee: Proposal 3
Opinion of the Rules Commission: In favour

Modifications of the Statutes, Proposals of the Executive Committee: Proposal 4
Opinion of the Rules Commission: In favour

Modifications of the Statutes, Proposals of the Executive Committee: Proposal 5
Opinion of the Rules Commission: In favour

Modifications of the Statutes, Proposals of the Legal, Medical and PP Commissions and Women and Fencing Council, Proposal 1

Opinion of the Rules Commission: In favour. This measure is essential to the FIE and the Rules Commission encourages the Woman and Fencing Council to find additional means to include women into our sport at all levels.

Modifications of the Statutes, Proposals of the Legal, Medical and PP Commissions and Women and Fencing Council, Proposal 2

Opinion of the Rules Commission: In favour. This measure is essential to the FIE and the Rules Commission encourages the Woman and Fencing Council to find additional means to include women into our sport at all levels.

Rules

Modifications of the Rules, Proposals of the Executive Committee, Proposal 1

Opinion of the Rules Commission: In favour

Modifications of the Rules, Proposals of the Executive Committee, Proposal 2

Opinion of the Rules Commission: In favour

Modifications of the Rules, Proposals of the Executive Committee, Proposal 3

Opinion of the Rules Commission: In favour

Modifications of the Rules, Proposals of the Executive Committee, Proposal 4

Opinion of the Rules Commission: In favour

Modifications of the Rules, Proposals of the Executive Committee, Proposal 5

Opinion of the Rules Commission: Not in favour. If this proposal is for the benefit of the athletes, it should be implemented also for junior world cups. Conditions should be the same during the season.

Modifications of the Rules, Proposals of the Executive Committee, Proposal 6

Opinion of the Rules Commission: In favour with the following changes due to the fact that Zonal Championships can take place any day of the week:

1. Delete the words "~~et aux Championnats de zone juniors et seniors.~~ » from article o.54
2. Modify o.53 :

FRANCAIS

o.54

Inscriptions nominatives aux compétitions de la Coupe du Monde, junior, senior, compétitions Grand Prix, compétitions satellites, Coupe du Monde par équipes junior et senior ~~et aux Championnats de zone juniors et seniors.~~

o.53

Inscription aux Championnats du Monde (toutes catégories) **et Championnats de zone juniors et seniors**

- 1 **Pour les Championnats du Monde**, les fédérations recevront du Comité organisateur **trois mois** avant le début des épreuves, un **formulaire d'inscription en nombre**. Elles seront tenues d'indiquer le nombre de tireurs et d'équipes participant à chaque épreuve dans le programme de compétition **deux mois** avant le début de la première épreuve.

- 2 L'inscription nominative des tireurs et des équipes s'effectue sur le site Internet de la FIE. Cette inscription nominative des tireurs et de tout remplaçant éventuel, et l'inscription des équipes, doit être effectuée :
- au plus tard 15 jours (minuit heure de Lausanne) avant la première épreuve des Championnats du Monde
 - au plus tard 7 jours (minuit heure de Lausanne) avant la première épreuve des championnats de zone.
- 3 Retrait d'un tireur

Après la clôture des inscriptions, il ne peut être procédé à aucun retrait de nom sauf en cas de force majeure dûment justifiée.

En cas de non-présentation d'un tireur ou d'une équipe inscrits, une amende (cf. article o.86 tableau des pénalités financières et amendes), payable à la FIE, sera infligée à la Fédération du tireur ou de l'équipe fautifs, sauf en cas de force majeure dûment justifiée.

- 4 Ajout de tireur(s) hors délai
- Toutefois, jusqu'à la veille de la compétition 10h00, heure locale de la ville hôte des championnats du Monde ou de zone, un ou des tireurs peuvent être ajoutés, après paiement à la FIE d'une pénalité (cf. article o.86 tableau des pénalités financières et amendes) par inscription ajoutée.

Pour ce faire, les fédérations nationales doivent adresser à la FIE une demande d'ajout de tireur(s) et régler la pénalité immédiatement.

- 5 Un changement de nom ne pourra intervenir qu'avec l'accord de la FIE ~~et seulement en cas de force majeure~~ et au plus tard 24 heures avant le commencement de chaque épreuve.

ENGLISH

o.54

Entries by name for Senior and Junior World Cup competitions, Grand Prix competitions, Satellite competitions, Junior and Senior World Cup team competitions ~~and Zonal-senior and junior Championships.~~

o.53

Entries for World Championships (all categories) and junior and senior zonal championships

o.53. 1. Three months before the start of the ~~World Championships-events~~, the federations will receive an **entry form** from the Organising Committee, on which they are required to specify the **number** of fencers and teams participating in each event of the competition's programme, two months before the start of the first event.

2. The entry of fencers and teams by name is to be made via the FIE website. This entry of the names of the fencers and all possible substitutes, and the entry of teams, must be made:

- fifteen days (by midnight, Lausanne time) before the first event of the ~~World Championships~~ at the latest.

- seven days (by midnight, Lausanne time) before the first event of the Zonal Championships at the latest.

3. Withdrawal of a fencer.

After the **cut-off date** for entries, there can be no further withdrawal of a name except in any case of force majeure duly justified.

Should a fencer or team who have been entered **not present themselves to fence**, their federation will be penalised by a **fine** (cf o.86, table of financial penalties and fines), payable to the FIE, except in cases of properly authenticated 'force majeure'.

4. Addition of fencer(s) after the cut-off date.

Nevertheless one or more fencers may be added, up until 10.00am (local time in the town hosting the World or Zonal Championships) on the day before the competition, after payment to the FIE of a penalty (cf o.86, table of financial penalties and fines) per fencer added. To do this the national federation must address a request to the FIE to add a fencer, together with immediate payment of the penalty.

5. Changes of names, only with the agreement of the FIE and ~~only for reasons of 'force majeure'~~, can only be made at the latest up to 24 hours before the start of each event

Modifications of the Rules, Proposals of the Executive Committee, Proposal 7

Opinion of the Rules Commission: In favour

Modifications of the Rules, Proposals of the Executive Committee, Proposal 8

Opinion of the Rules Commission: In favour

Modifications of the Rules, Proposals of the Executive Committee, Proposal 9

Opinion of the Rules Commission: In favour, with the exception that the conductive jacket at foil and sabre should not be included in the national uniform and that the translation of the new text in m.25.3.e in English should be improved:

General conditions

m.25

The national uniform includes the socks, the trousers, and the jacket, ~~and the conductive jacket at foil and sabre.~~ (Cf. m.28, m.34).

3 CHARACTERISTICS OF THE CLOTHING:

- e) There shall be only one national uniform per country, with the exception that the manufacturers' marks and sponsors' logos may be different. ~~with the exception of the manufacturer's mark and the logo of the sponsors.~~

Application as follows: 1st of January 2016

Modifications of the Rules, Proposals of the Executive Committee, Proposal 10

Opinion of the Rules Commission: In favour

Modifications of the Rules, Proposals of the Executive Committee, Proposal 11

Opinion of the Rules Commission: In favour of the proposal as modified by the SEMI Commission. Pierre Thullberg and Lutz Schirmacher made a reservation against the decision.

Modifications of the Rules, Proposals of the Executive Committee, Proposal 12

Opinion of the Rules Commission: Not in favour.

Modifications of the Rules, Proposals of the Executive Committee, Proposal 13

Opinion of the Rules Commission: In favour. The Commission agrees in principle and awaits a formal proposal from the SEMI Commission

Modifications of the Rules, Proposals of the Refereeing Commission, Proposal 1

Opinion of the Rules Commission: In favour

Modifications of the Rules, Proposals of the Refereeing Commission, Proposal 2

Opinion of the Rules Commission: In favour but with the same wording as for foil:

4. The electrical contact between the conductive jacket and the mask must be ensured by means of a white-colored or clear covered wire with one or two crocodile clips. The wire must be attached to the mask with one crocodile clip or by soldering and to the jacket with a crocodile clip. This wire must be between 30cm and 40cm long. *A coiled mask wire is not allowed.*

Modifications of the Rules, Proposals of the Refereeing Commission, Proposal 3

Opinion of the Rules Commission: In favour with the following wording:

Technical Rules:

t.18.5. The order 'Halt!' is also given if the play of the competitors is **dangerous, confused, or contrary to the Rules**, if one of the competitors is **disarmed** or **steps off the piste**, or if, while retiring, he approaches too near the spectators or the Referee (cf. t.26, t.54.5 and t.73.4.j).

At foil it is forbidden, during the course of fencing, to advance the shoulder of the non-sword arm in front of the shoulder of the sword-arm (cf.t.19). If a competitor does so he is liable to incur the penalties enumerated in Articles t.114, t.116, t.120. □Any hits scored by the fencer at fault while committing this offence will annulled.

Modifications of the Rules, Proposals of the Refereeing Commission, Proposal 4

Opinion of the Rules Commission: In favour

Deferred Proposals

1. Deferred proposal of the Hungarian Fencing Federation

Opinion of the Rules Commission: In favour of the proposal of the working group with the following wording in French and English:

Eng

If a fencer crosses the lateral boundaries of the piste, with one or both feet, he must be placed on guard at the correct distance, even if this means that he is placed behind the rear line and thus causes a hit to be awarded against him. (cf t.28, t.102).

Fra

Si un tireur franchit les limites latérales de la piste, d' un ou des deux pieds, il doit être mis en garde à la distance correcte, même si cela implique qu'il est placé au-delà de la ligne arrière et est pénalisé d'une touche.

2. Deferred proposal of the Russian Fencing Federation

Opinion of the Rules Commission: Not in favour. The new sensor should be introduced before any more reforms are tried in sabre.

3. Deferred proposal of the Swedish Fencing Federation

Opinion of the Rules Commission: In favour of the proposal of the working group with the following change: The multiplier for individual zonal championships should be 1,5.

4. Deferred proposal of the Swedish Fencing Federation

Opinion of the Rules Commission: In favour of the proposal of the working group

5. Deferred proposal of the Swedish Fencing Federation

Opinion of the Rules Commission: In favour of the proposal of the working group

Proposals concerning Veteran Championships

Proposals from the Veterans Council to the Executive Committee, Proposal 1

Opinion of the Rules Commission: In favour of the proposal with the following wording (identical to the opinion of the Veteran Council):

o.87

1. The organisers must submit the programme of events to the Executive Committee for its approval.
2. The programme must be arranged in such a way to allow any fencer to participate to all weapons. Team events must be held on the day following the last championship of the three categories of each weapon.
3. No changes of days are allowed for each competition, after the release of the programme.
4. Each competition must be held in one single day, avoiding long inactive time along the progress of it.

Proposals from the Veterans Council to the Executive Committee, Proposal 2

Opinion of the Rules Commission: In favour of the proposal with the following wording (identical to the opinion of the Veteran Council):

o.88 Entries for competitions

1. Entries must be sent to the organisers by the competitors' national federation. Entries shall be sent not later than one month before the beginning of the championships.
2. However, until two days before the competition at noon (local time), fencers may be added by their national federation after payment to the Organizing Committee of a penalty equal to 100 % of the registration fee.
3. Entries for team championships must be forwarded to the Directoire Technique not later than 4.00 pm (local time) of the day before the competition.

Proposals from the Veterans Council to the Executive Committee, Proposal 3

Opinion of the Rules Commission: In favour of the proposal with the following wording (identical to the opinion of the Veteran Council):

o.89

At the Veterans World Championships, entries for the individual events are limited to four fencers in each category per gender, per weapon and per nation. [The names must be consistent with FIE licences.](#)

Proposals from the Veterans Council to the Executive Committee, Proposal 4

Opinion of the Rules Commission: In favour of the proposal with the following wording (identical to the opinion of the Veteran Council):

o.90 Composition of the pools [for individual championships](#)

When drawing the pools, the Directoire Technique will take into account the following orders of strength:

1. The [64 highest ranked from the addition of the results in the two last years](#) Championships, irrespective of age category changes;
2. All other fencers in order of age, starting from the youngest.
3. The allocation of fencers in the pools must be made in such a way as to place fencers of the same nationality, as far as possible, in different pools, by moving them down the ranking as necessary.
4. If in any category there are fewer than ten competitors, the competition is held as a poule unique plus direct elimination.
5. If in any category there are fewer than 6 competitors, they will fence with the lower age category. A separate ranking for this category will be extrapolated from the combined categories final rankings at the end of the competition.
6. If in any category there is only one competitor, the event in that category is cancelled.
7. [No fencer is eliminated after the poules, all enter into direct elimination.](#)

o.91 Duration of the matches

The direct elimination bouts are for 10 hits or end when two periods of three minutes, with one minute rest between the periods, have passed. As an exception, at sabre, the first period ends either at the expiry of the three minutes or when one of the fencers has scored five hits.

Proposals from the Veterans Council to the Executive Committee, Proposal 5

Opinion of the Rules Commission: In favour of the proposal with the following wording (identical to the opinion of the Veteran Council):

o.92. Team championships

1. Participation

[Each country can enter one team per gender and per weapon, thus giving place to 6 competitions.](#)

2. The rules for team championships are applicable with the following exceptions:

a) [For each weapon, the teams are constituted by three fencers of the same nationality, one from category "A", one "B" and one "C" with or without one reserve for each category. A team cannot begin the match if it is not complete.](#)

b) In the case of a team being short of a fencer in a weapon the team may use a fencer who has competed in the individual championships at another weapon, but his/her ranking will be deemed to be the last ranking at that weapon plus 1.

c) The teams are placed in the poules according to the ranking of the three fencers in the individual championship, the highest place for those having the lowest total. All the fencers registered for the team event must be present at the piste before the start of the match.

d). Each team may ask to substitute a fencer before the start of the bout, except in case of injury duly recognized by the Medical delegate, when the substitution can be immediate. There can be only one replacement per match.

3. The fencer who has been replaced because of an injury may not fence again during that match. If both a fencer and the reserve, if any, are forced to retire, or if a fencer is excluded, their team has lost the match.

4. The relay system is always applied. The three fencers of a team fence against the opponent of the same category. Each fencer fences twice his/her opponent for a total of 6 bouts. The bouts are for 5 hits (5-10-15-20- etc.); the maximum time for each bout is 3 minutes.

5. The team that first reaches the maximum score of 30 hits, or that which has scored the greatest number of hits after the expiry of regular time, is the winner.

6. The order of categories for each match is established by the referee with the captains on the piste prior to the match starting: The referee will "toss a coin" and the winning captain will select the first category in the order. The losing captain will select the second category.

8. The competition consists of a round of poules of 3 or 4 teams, in which all the teams participate, and a direct elimination phase for a maximum of 16 teams, the other teams will be classified according to their place after the round of poules.

9. If there are less than 6 teams, after an unique poule, a match for the 3rd and 4th places is held, then a match for the first place between the 1st and the 2nd.

Proposals from the Veterans Council to the Executive Committee, Proposal 6

Opinion of the Rules Commission: In favour of the proposal with the following wording (identical to the opinion of the Veteran Council):

o.93 Referees

Refereeing Veteran World Championships is carried out by referees appointed by the Executive Committee of the FIE, selected by the Refereeing Commission on indication of the Organizing Committee. Fifteen of them shall be of at least eight different nationalities, being no more than two of each nationality; the other necessary referees shall be from the organizing country. In case of unavailability of sufficient national referees, they will be chosen by the Organizing Committee from nearby countries.

Referees' travel and board and lodging costs are paid by the organising committee who in return will receive all the entry fees, as stated in art. 6.2 of Administration Rules.

Referees must attend the refereeing meeting that takes place the day before the World Championships.

Proposals from the Veterans Council to the Executive Committee, Proposal 7

Opinion of the Rules Commission: In favour of the proposal with the following wording (identical to the opinion of the Veteran Council):

o.94 Invitations for international officials

1. Any proposed candidature for organising the World Championships must be studied at the venue concerned by a delegate designated by the Executive Committee, at the invitation of the candidate federation.
2. The organising committee of the World Championships, who will receive all the entry fees from the participating delegations, must, at their own expense, invite the following international officials (tourist-class return air fare, accommodation and daily allowances):
 - a) The President of the FIE or his representative, who presides over the World Championships and, in particular, controls the smooth running of the Directoire Technique.
 - b) **Four** members of the Directoire Technique appointed by the Executive Committee of the FIE, one of whom must belong to the organising country.
 - c) One member of the SEMI Committee, appointed by the Executive Committee of the FIE.
 - d) One member of the Refereeing Committee, appointed by the Executive Committee of the FIE.
 - e) One member of the Medical Committee, appointed by the Executive Committee of the FIE.

These official shall be preferably be selected from the same Zone of the Championships.

Proposals from the Veterans Council to the Executive Committee, Proposal 8

Opinion of the Rules Commission: In favour of the proposal

Proposals from the Veterans Council to the Executive Committee, Proposal 9

Opinion of the Rules Commission: In favour of the proposal with the following wording (identical to the opinion of the Veteran Council):

HANDBOOK OF REGULATIONS

1.2 DESIGNATION AND EXPENSES

The Organisation Committee will pay for the expenses of the President of the FIE or his representative (plane ticket in economy class, lodging and per diem), in accordance with article **o.89** of the FIE Organisation Rules.

Officials

According to financial arrangements stipulated in Chapter 7 of the Administrative Rules of the FIE, the following officials are designated by the Executive Committee of the FIE and reimbursed by the organisers:

- four (4) members of the Directoire technique, including **one** from the host country;
- one (1) delegate of the Refereeing Commission;
- one (1) delegate of the SEMI Commission;
- one (1) delegate of the Medical Commission.

These officials shall preferably be selected from the same Zone of the Championships.

3. Progress of rules revision work

The Commission started the study of the drafts for revised technical rules and rules for organisation. Due to the short time, this work will be completed by e-mail within the next week. The aim is to deliver the final text to the FIE by mid-August.

4. Meetings with other commissions and councils (Friday)

Women and Fencing Council: Rusni Abu Hassan, Manuel Rondon Nieves

SEMI Commission: Medhat El-Bakry, Ziad Feriani as well as a visit to the Commission from Mr. Varallo

Refereeing Commission: Manuel Belmonte, Lutz Schirrmacher

Veterans Council: Giuseppe Cafiero, Pierre Thullberg

Medical Commission: Pierre Thullberg, Ziad Feriani, Janine Lamon

Coaches' Council and Athletes' Council: Rusni Abu Hassan, Mehdat El-Bakry, Giuseppe Cafiero

5. Letter of FIE Secretary General

The Commission decided by a majority vote on an answer to the letter with a proposal for an urgent decision of the Executive Committee as in annex 1.

6. Proposition of urgent decision of the Executive Committee concerning medical breaks

The frequency of medical breaks in competitions is showing a tendency to increase. It is clear that the medical breaks in fencing are considerably longer than what is allowed in most other combat sports. It would be desirable to have a change in this respect before the start of the Olympic season. After consultation with the Medical Commission, it seems to be the case that five minutes should be sufficient for treatments in the case of injuries of such a nature that an athlete can be expected to be able to continue.

The Rules Commission supports the proposal to reduce the time allowed for medical intervention and proposes that it is changed by an urgent decision to reduce the risk of long medical breaks in the 2016 Olympic Games (see proposal below).

t.33. 1.

For an **injury or cramp** which occurs in the course of a bout and which is properly attested by the delegate of the FIE Medical Committee or by the doctor on duty, the Referee will allow a break in the fight lasting no longer than 5 ~~40~~-minutes. This break should be timed from the point when the doctor gave his opinion and be strictly reserved for the treatment of the injury or cramp which brought it about. If the doctor considers, before or at the end of the 5 ~~40~~-minute break, that the **fencer is incapable of continuing** the fight, he will decide that the fencer should retire (individual events) and/or be replaced, if possible (team events) (cf. o.44.11.a/b).

7. Proposition of urgent decision concerning consistency between m.25 and t.45

When article t.45.4 b) was changed according to the decision of the FIE congress of 21st November 2014, no similar change was made to article m.25.3 g) which has resulted in a difference between these two articles. In order to align them it is suggested to amend article m.25.3 g) to have the same wording in sub-bullets i) – iii) as in article t.45.4 b) as outlined below. To avoid any misunderstandings for the coming season it is suggested that this change is made by urgent decision.

m.25.3

g) For the following events, the wearing of national strips (logos) is **compulsory** on both legs, optional on the arm(s) (cf. t.45.4). All the logos worn by any one fencer must be identical.

i) Senior, Junior and Cadet World Championships: ~~and World Junior and Cadet Championships: every~~ all bouts, whether in the pools, in the direct elimination ~~and in~~ during a team matches;

ii) Individual: Senior World Cup competitions and in individual Senior Zonal Championships: all bouts, whether in a pool or in the direct elimination ~~bouts from the 64 onwards~~;

iii) Teams: Senior World Cup team competitions and Senior Zonal Championships: all bouts in every match.

They must be **identical** for all fencers of the same federation for the competitions i) and iii) above.

8. Miscellaneous

a) A number of suggested rule modifications have been received from the Iranian Federation. Since the rules are currently under substantial revision, the Commission agreed to examine the proposals within the framework of this project.

b) An interpretation of o.43.5 has been discussed with Referee commission
o.43.

5. Each 'lap' (bout) of the relay match consists of **five hits** (5, 10, 15, 20, etc.); the maximum time for each bout is **3 minutes**.

The opinion of the Rules commission is:

In team events, in the case a fencer receives both a hit and a red card when the score is one hit under the maximum for the relay, the score is limited to the multiple of 5 for that relay and not with an additional hit added (e.g. 35-x and not 36-x after the 7th relay).

The problem of non combativity might put fencing in a dangerous position in the next Olympic Games if not efficiently resolved. The General Secretary has asked to propose a change in the rules that could be urgently approved in the next Comex.

The present rules are no more capable to avoid the tactical choice not to fence, because of the absence of any sanction and the growing attitude of coaches and fencers to concentrate all the risk into the last moments of the match.

There is no need to emphasize that this behaviour is against the spirit of our sport and it is necessary to demonstrate that adopting it will result in a heavy penalty.

First of all we must distinguish two different situations:

- The first is a situation in which the fencers are actually fighting, more or less intensively, but they do not succeed or they do not really try to hit for at least a minute. It does not necessarily imply a voluntary intention, but for image reasons it must be eliminated.
- The second is the evidence of the unwillingness to fight by keeping an excessive distance or even lowering the weapons for some seconds (the present rule indicates 15 sec.). This case implies a voluntary common decision not to fence.
- A sanction is necessary in both cases.

In both cases, unwillingness to fight is always considered a common responsibility of both fencers.

The rules can be amended as follows:

t.87

Present text	New proposal
<p>Unwillingness to fight 4. When both fencers make clear their unwillingness to fight, the Referee will immediately call 'Halt!'</p>	<p>4. If either of the two criteria for non-combativity below is present, the referee should call halt and the following rules and sanctions will apply.</p> <p>1. Absence of hits Criterion of time: one minute of fencing without a hit; 2. Unwillingness to fight Excessive distance (greater than the distance of a step-forward-lunge) or the fencers lowering their weapons for 15 seconds.</p>
<p>Unwillingness to fight (non-combativity) If one of the two criteria below is present, there is unwillingness to fight: 1. criterion of time: approximately one minute of fencing without a hit 2. excessive distance (greater than the distance of a step-forward-lunge) during at least 15 seconds.</p>	

<p>5. Individual events</p> <p>a) If during the first two periods of a direct elimination bout both fencers make clear their unwillingness to fight, the Referee will proceed to the next period, without the minute rest.</p> <p>b) When both fencers make clear their unwillingness to fight during the third period of a direct elimination bout, the Referee will proceed to a last minute of fencing. This last minute, which must be fenced in its entirety, will be decisive and will be preceded by a drawing of lots to decide the winner should the scores be equal at the end of the minute.</p>	<p>5. Individual matches</p> <p>a) If, during the first two periods of a direct elimination bout, there is non-combativity, the Referee will sanction both of them with a yellow card and proceed to the next period, without the minute rest. If this situation is repeated during the same bout, the Referee will disqualify both fencers.</p> <p>b) If non-combativity occurs for the first time during the third period of a direct elimination bout, the Referee will sanction both of them with a yellow card and proceed to a last minute of fencing. This last minute, which must be fenced in its entirety, will be decisive and will be preceded by a drawing of lots to decide the winner, should the scores be equal at the end of the minute.</p>
<p>6. Team events</p> <p>a) If both teams make clear their unwillingness to fight during a team match, the Referee will proceed to the next bout.</p> <p>b) If both teams make clear their unwillingness to fight during the last bout, the Referee will proceed to a last minute of fencing. This last minute, which must be fenced in its entirety, is decisive and is preceded by a drawing of lots to decide the winner should the scores be equal at the end of the minute</p>	<p>6. Team events</p> <p>a) If there is non-combativity during a team match, the Referee will sanction both teams with a yellow card and proceed to the next bout. If this situation is repeated during the same team match, the Referee will disqualify both teams.</p> <p>b) If non-combativity occurs for the first time during the last bout, the Referee will sanction both teams with a yellow card and proceed to a last minute of fencing. This last minute, which must be fenced in its entirety, will be decisive and will be preceded by a drawing of lots to decide the winner, should the scores be equal at the end of the minute.</p>

PROPOSALS SUBMITTED TO THE RULES COMMISSION 2015 CONGRESS

MODIFICATIONS OF THE STATUTES Proposals of the Executive Committee

Proposal 3

Motivation: The current entry fee is too low and has not changed for years, although the costs of the organizers have been increasing.

6.2 Amounts to be paid to the organizers:

Subjet	Euros
Entry fee junior A grade tournament	15 25

Opinion of the Rules Commission: In favour.

Proposal 4

Motivation: Any competition organization should be subject to payment of an entry fee. It is not normal that an organizer perceives nothing in return for hosting a competition.

6.2 Amounts to be paid to the organizers:

Subjet	Euros
Entry fee junior team tournament	100

Opinion of the Rules Commission: In favour.

Proposal 5

Motivation: Align the text on this Commission to the text of all the other commissions, as adopted by Congress in 2014.

6.5.2 *The Rules Commission*

- a) The Rules Commission presents a report [to the Executive Committee which will be submitted to the](#) Congress on any proposal concerning the organisation and running of competitions, equipment and material (in co-operation with the

SEMI Commission), the way to fence an opponent, the rules for fighting a bout, behaviour on and around the piste, and the penalties relating to these proposals.

Opinion of the Rules Commission: In favour.

Proposals of the Legal, Medical and PP Commissions and Women and Fencing Council

Proposal:

That the minimum representation of men and women on the FIE Executive Committee and all FIE Commissions and Councils should be raised from 20% to 30%.

Rationale:

In 2007 the Olympic Charter was amended to include, for the first time in history, the following:

"The IOC encourages and supports the promotion of women in sport at all levels and in all structures, with a view to implementing the principle of equality of men and women."
Rule 2, paragraph 7, Olympic Charter in force as from 07.07.2007

The International Olympic Committee (IOC) has publically committed itself to increasing the number of women occupying leadership positions within the Olympic Movement. Twelve years ago, in 2003, the FIE Congress took the decision to require minimum representation of 20% of men and women on the FIE Executive Committee and all FIE Commission.

In line with the commitment of the IOC and best practice in organisational governance, it is now time to increase gender balance in the FIE by increasing the minimum representation of men and women on all FIE Commissions and Councils to 30%.

Proposed changes to FIE Statutes:

Proposal 1

4.3.4: In order to secure the principle of equal treatment, women and men must be represented in overall view by at least ~~20~~ 30% of the elected members of the Executive Committee. If the 15 candidates who have obtained the most votes do not include at least ~~3~~ 5 persons of each gender, the Executive Committee will consist of the ~~3~~ 5 candidates for the Executive Committee who have obtained the greatest number of votes of the gender not otherwise being so represented and the ~~12~~ 10 candidates of the other gender who have obtained the greatest number of votes.

If there are less than ~~3~~ 5 candidates of either gender, that gender will be represented by the number of candidates put forward and the remainder of the Executive Committee will consist of the candidates of the other gender who have obtained the most votes.

Opinion of the Rules Commission: : **In favour.** This measure is essential to the FIE and the Rules Commission encourages the Woman and Fencing Council to find additional means to include women into our sport at all levels.

Proposal 2

4.4.4: If the 10 first members elected do not include ~~two~~ 3 members of each gender, the Commission will consist of the first ~~8~~ 7 members elected and the ~~two~~ 3 members of the other gender who are candidates for the commission and who have obtained the greatest number of votes. If no candidate of either gender has offered herself/himself as candidates, the 10 candidates of different nationalities with the greatest number of votes are elected.

Opinion of the Rules Commission: In favour. This measure is essential to the FIE and the Rules Commission encourages the Woman and Fencing Council to find additional means to include women into our sport at all levels.

PROPOSALS SUBMITTED TO THE RULES COMMISSION 2015 CONGRESS

MODIFICATIONS TO THE RULES Proposals of the Executive Committee

Proposal 1

p.10 Position and sizes

- 1 The articles of the fencers' **equipment** may carry the following visible marks:
 - a) **mask**: one mark on the rear of the spring. Maximum size: ~~6 x 5.5 cm~~ 12.5 cm².
 - b) **jacket**: one mark at the bottom of the jacket on the hip on the side of the non-sword arm. Maximum size: ~~4.5 x 2 cm~~ 30 cm².
 - c) ~~breeches~~ trousers: one mark at the bottom ~~of the breeches~~ of the trousers, on one side only. Maximum size: ~~4.5 x 2 cm~~ 30 cm².
 - d) **stockings socks**: one mark on each ~~stocking sock~~. ~~in size 4.5 x 2 cm~~. Maximum size: 10 cm².
 - e) **shoes**: the name of the brand on each shoe. Maximum size: ~~4.5 x 2 cm~~ 10 cm² or the usual logos (e.g.: bands).
 - f) **glove**: ~~no mark~~. One mark: maximum size: 10 cm². If the mark is affixed on the glove with the help of a label (glued or sewn), the latter must be placed on the cuff.
 - g) **weapon**: ~~no mark visible at a distance~~. ~~One mark~~. Maximum size: 2.5 cm².
 - h) **electric jacket**: one mark at the bottom of the jacket on the hip of the side of the non-sword arm. Maximum size: 30 cm².

Application as follows: 1st of January 2016

Opinion of the Rules Commission: In Favour.

Proposal 2

Motivation: Allowing fencers to take advantage of potential sponsors.

p.12

2 Fencing clothing and equipment

- a) If a federation and/or a fencer have signed a **sponsorship contract** with a commercial or other company, the logo of that sponsorship partner, maximum 125 cm² in size, may be affixed at the top of the sleeve of the fencing jacket (non-sword arm), on the side of the trousers (left or right), or on the socks. At sabre, a logo may not be worn on the sleeve.
The sponsor(s) logo may be displayed on each side of the mask. Maximum size: 100 cm² on each side of the mask.
- b) The **number of logos** shall not exceed **four-five**. The **total surface** of all logos added together may not exceed a total of 500 square centimetres.

Application as follows: 1st of January 2016

Opinion of the Rules Commission: In Favour.

Proposal 3

Motivation: The following is no longer part of common practice. Furthermore, it may provoke conflicts with the sponsors of athletes or federations. Therefore, the proposal is to remove the following articles from the Publicity Code:

~~p.12.5.b) As far as possible, the **organisers** must make it clear, in the conditions of entry for the competition, the way in which advertising material worn or carried by the fencers will be permitted.~~

~~LEG-BAND OR SELF-ADHESIVE NOTICE~~

~~p.13~~

~~1 Principles~~

- ~~a) The organisers of a competition may identify the fencers by issuing them with a number on a **leg-band** or on a **self-adhesive badge**.~~
- ~~b) In such a case, the wearing of this **band** or **badge** is obligatory for the fencers.~~
- ~~c) The **self-adhesive badge** must be of a rough material which will not cause the point to slip.~~
- ~~d) The **leg-band** or **self-adhesive badge** may have on it advertising material within the limitations of the rules below.~~
- ~~e) The **circular** announcing the details of the competition must make clear what bands or badges the fencers are to wear, and what publicity will be on them.
Entering the competition implies an acceptance by the fencer of the obligation to wear the band or badge in question.~~

~~2 Position and size~~

- ~~a) The **leg-band** must be fixed to the thigh on the side of the non-sword arm. The maximum **size** of the leg-band is of 20 x 20 cm. The fencer's number must be at least 10 cm high and 15 cm in width.~~

~~.b) The self-adhesive badges must be fixed to both sides of the mask, on the side mesh.~~

~~The maximum size of the badges must be 10 cm wide by 15 cm high. The fencer's number must be no more than 8 cm high by 8 cm wide. At foil and épée only the self-adhesive badge of the competition taking place must be worn.~~

~~c) In both cases, the advertising, words or badge, must be placed below the number and must not exceed 35 mm in height.~~

~~.d) If the self-adhesive badge on the mask does not include a number, it may only be used for advertising following agreement with the FIE.~~

Application as follows: 1st of January 2016

Opinion of the Rules Commission: In Favour.

Proposal 4

Motivation: Clarifying the criteria for ranking fencers in the case of a barrage following the pools.

o.32. 2. After the round of pools, the 16 fencers ranked highest on the general index (cf. o.19) are exempt from the preliminary direct elimination table. Should there be a tie between two or more fencers for the 16th place, there will be a barrage for 5 hits to decide who is ranked 16th. **Following the barrage, the ranking of the fencers shall be determined according to V, TD-TR, TD.**

Opinion of the Rules Commission: In Favour.

Proposal 5

Motivation: Shorten the hours of competitions for the benefit of the athletes.

o.40

1 All the fencers qualifying from the round of pools are placed in a direct elimination table, complete or incomplete, according to the **indices resulting from the pools**. This table is fenced right through to the final.

2 **For the juniors World Cup competitions, from the last 32 the direct elimination bouts will take place on 4 pistes**, with each quarter of the table fenced on one piste.

For the cadets and juniors World Championships, from the last 32 the direct elimination bouts will take place on 8 pistes, with each quarter of the table fenced on 2 pistes.

Opinion of the Rules Commission: Not in favour. If this proposal is for the benefit of the athletes, it should be implemented also for junior world cups. Conditions should be the same during the season.

Proposal 6

Motivation: permitting the replacement of a fencer up until the Wednesday preceding the competition.

o.54

The entry of the names of the fencers for the competitions of the World Cup, juniors, seniors, Grand Prix competitions, juniors and seniors team World Cup, and juniors and seniors Zone Championships.

3 Substitution of a fencer

Until the ~~Tuesday~~ **Wednesday (midnight, Lausanne time)** preceding the competition, a fencer may be replaced by another. To do this, the national federation must send to the FIE, by fax or e-mail, a written request to substitute the fencer.

Application as follows: 1st of January 2016

Opinion of the Rules Commission:

In favour with the following changes due to the fact that Zonal Championships can take place any day of the week:

1. Delete the words "~~et aux Championnats de zone juniors et seniors.~~ » from article o.54
2. Modify o.53 :

ENGLISH

o.54

Entries by name for Senior and Junior World Cup competitions, Grand Prix competitions, Satellite competitions, Junior and Senior World Cup team competitions ~~and Zonal senior and junior Championships.~~

o.53

Entries for World Championships (all categories) **and junior and senior zonal championships**

o.53. 1. Three months before the start of the **World Championships events**, the federations will receive an **entry form** from the Organising Committee, on which they are required to specify the **number** of fencers and teams participating in each event of the competition's programme, two months before the start of the first event.

2. The entry of fencers and teams by name is to be made via the FIE website. This entry of the names of the fencers and all possible substitutes, and the entry of teams, must be made:

- fifteen days (by midnight, Lausanne time) before the first event of the **World Championships** at the latest.
- **seven days (by midnight, Lausanne time) before the first event of the Zonal Championships** at the latest.

3. Withdrawal of a fencer.

After the **cut-off date** for entries, there can be no further withdrawal of a name except in any case of force majeure duly justified.

Should a fencer or team who have been entered **not present themselves to fence**, their federation will be penalised by a **fine** (cf o.86, table of financial penalties and fines), payable to the FIE, except in cases of properly authenticated 'force majeure'.

4. Addition of fencer(s) after the cut-off date.

Nevertheless one or more fencers may be added, up until 10.00am (local time in the town hosting the World or Zonal Championships) on the day before the competition, after payment to the FIE of a penalty (cf o.86, table of financial penalties and fines) per fencer added. To do this the national federation must address a request to the FIE to add a fencer, together with immediate payment of the penalty.

5. Changes of names, only with the agreement of the FIE and **only for reasons of 'force majeure'**, can only be made at the latest up to 24 hours before the start of each event

Proposal 7

Motivation: For the junior World Championships, increase the number of athletes in individual events to equal the one for entries to the junior's team events.

o.72

For the cadets World Championships, entries are limited to **three fencers per nation** for the individual events.

For the juniors World Championships, the entries are limited to **four fencers per nation** for each individual event, and **one team per nation** for the team events.

Application as follows: 1st of January 2016

Opinion of the Rules Commission: In Favour.

Proposal 8

Motivation: The number of athletes that can be entered and the participation of athletes in the various FIE competitions is listed in the Organisation Rules, **except for the Zone Championships**. Consequently, the proposal is to unify the system as follows:

- article 9.4.2 of the Administrative Rules (entries for the Zone Championships) is deleted (and the subsequent articles must be renumbered).

- the registration rules for the Zone Championships are integrated in the Organisation Rules as follows: the current article o.78 becomes o.78.1, the current article o.79 becomes o.78.2, and the registration rules for the Zone Championships are integrated in article o.79.

Participation

o.78

1. For **Grand Prix competitions and Individual World Cup competitions**, both Senior and Junior, at each weapon, each national federation may enter a maximum of 12 fencers. The organising country may enter up to 20 fencers plus the number needed to make up the pools.

2. For **Individual World Cup competitions outside Europe**, the organising country may enter up to 30 fencers plus the number needed to make up the pools.

o.79

For **juniors and seniors Individual Zone Championship competitions**, for each weapon, the federations may enter up to 4 fencers.

For **juniors and seniors Team Zone Championship competitions**, for each weapon, the federations may enter 1 team (consisting of three fencers with or without replacement).

Opinion of the Rules Commission: In Favour.

Proposal 9

Motivation: Clarification of the text in order to avoid incidents due to the interpretation of the rules.

General conditions

m.25

The national uniform includes the socks, the trousers, the jacket, and the conductive jacket at foil and sabre. (Cf. m.28, m.34).

3 CHARACTERISTICS OF THE CLOTHING:

- e) **There shall be only one national uniform per country, with the exception of the manufacturer's mark and the logo of the sponsors.**

Application as follows: 1st of January 2016

Opinion of the Rules Commission:

In favour, with the exception that the conductive jacket at foil and sabre should not be included in the national uniform and that the translation of the new text in m.25.3.e in English should be improved:

General conditions

m.25

The national uniform includes the socks, the trousers, **and** the jacket, ~~and the conductive jacket at foil and sabre. (Cf. m.28, m.34).~~

3 CHARACTERISTICS OF THE CLOTHING:

- e) There shall be only one national uniform per country, with the exception that the manufacturers' marks and sponsors' logos may be different. ~~with the exception of the manufacturer's mark and the logo of the sponsors.~~

Application as follows: 1st of January 2016

Proposal 10

Motivation: During the last two seasons, there have been several incidents involving masks which failed to properly secure the position of the mask on the fencer's head, in violation of the standard included in Annex 2.2.4 and of the urgent letter of the Executive Committee # 14 of 15 July 2014. The following modifications are therefore proposed, as well as the correction of a typing error in the French text.

m. 25.7 MASK:

- a) The **mask** must be made with meshes (space between the wires) of maximum 2.1 mm and from wires with a minimum gauge of 1 mm diameter. The mask must include ~~a safety strap at the rear~~ two different safety systems at the rear.
- f) The mask must contain ~~a horizontal safety strap~~ two different safety systems at the rear of the mask, with the two ends of ~~the strap~~ the straps of the systems firmly affixed to the two sides of the mask. ~~This strap may~~ These straps may be elastic or of any other material that is approved by ~~the~~ the S.E.M.I. Commission.

Please refer to the examples in the drawings below:

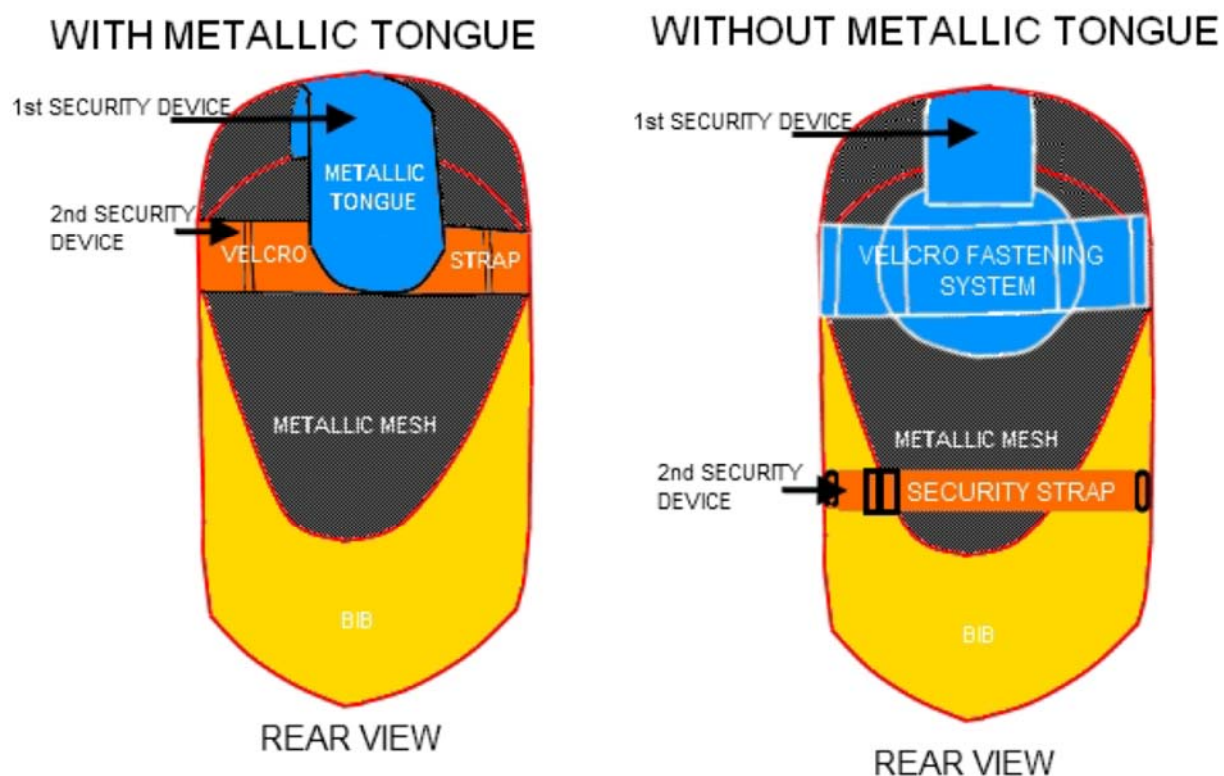

These images are only provided for information. When in doubt, the wording of the relevant text shall prevail.

EQUIPMENT

2. STANDARDS FOR THE MANUFACTURING OF MASKS

2.2

4 - Essential constituent elements

In particular, ~~the rear fixing device must ensure~~ the rear fixing devices must make sure that the mask is located in the correct position on the fencer's head and that it remains in a perfect position, even after blows or shocks.

Application as follows: 1st of January 2016

Opinion of the Rules Commission: In Favour.

Proposal 11

Motivation: During tests performed in 2009, it was established that the adequate blocking time allowing for spectacular actions, such as the parry and the riposte, is situated between 160 and 180 milliseconds. It has been, therefore, proposed to change the current time to 170 milliseconds.

ANNEX B

CHARACTERISTICS OF EQUIPMENT

C) SABRE

a) Principles

1) to 7), no change.

8) After a hit has been registered, a subsequent hit made by the other fencer will only be registered if it occurs within a maximum of ~~120~~**170 milliseconds** (± 10 ms tolerance).

9) and 10), no change.

Application as follows: vote during the 2015 Congress and, if the change is adopted, application starting with the season 2016-2017.

Opinion of the Rules Commission: In favour of the proposal as modified by the SEMI Commission. Pierre Thullberg and Lutz Schirmacher made a reservation against the decision.

Proposal 12

Motivation: Reintroducing the fleche for the sabre, because it is a spectacular action and it should be allowed for this weapon, as long as it is perfectly explained to referees so that they don't equate it to another action.

t.75

5 - The step forward, ~~the fleche~~ and any forward movement in which the rear foot completely passes the front foot is forbidden. Any offence will be penalised as specified for penalties in the 1st group (cf. t.114, t.116 and t.120). Any hit scored by the fencer at fault will be annulled. However, any hit correctly executed by his opponent is valid.

Application as follows: vote during the 2015 Congress and, if the change is adopted, application starting with the season 2016-2017.

Opinion of the Rules Commission: Not in favour.

Proposal 13

It would be helpful for the fencing world to consider a new sensor for the sabre, using available technologies.

The old sensor was a mechanical sensor (physical contact).

A small steel ball was held by two springs in a small metal pipe. When the hit reached its target with sufficient force (500 g), the ball moved and closed the circuit.

Numerous problems were immediately identified:

- If the movement was perfectly linear, the ball did not touch the pipe and did not close the circuit.
- The 500 g varied depending on the springs used by the manufacturer and their age, therefore, there could be differences from one weapon to the other.
- The greater the tilt of the blade, the less the sensor worked.

With the new, inexpensive technology derived from the automotive industry, we are able to start considering the production of a new electronic sensor using MEMS.

The **MEMS (Microelectromechanical Systems)** technology is the technology of very small devices; we are talking of the nanometric scale of nanoelectromechanical systems (NEMS) and of nanotechnology.

Today, the MEMS are mainly used to detect movement inside mobile elements, for example, air bags, smartphones, GPS. In sports, they are used in tennis, golf, and baseball.

The final product will be a square with sides of approximately 25 mm and 4/6 mm thickness. It will include a battery, one or two MEMS, and electronic circuits for power supply and the MEMS. It will be easy to place in the sabre guard.

The project will have to involve a specialised company and/or a university laboratory as the 1st trial. The development phase of the software is long and complicated, as is always the case when developing low level software.

The SEMI Commission may coordinate the sports aspects of the project (specification of data to be collected, and trials on the piste).

STAGES OF THE PROJECT

- ▶ Measurement of loads, limitations, speed, and energy absorbed during typical real attacks, using adapted sabres. HD video recording of attacks. Data analysis. Determining the minimum force of the hit (500 g) and possible decisions to prevent hits in certain specific directions (for example, rectilinear, with only the button).
- ▶ Selection of suitable MEMS (1 or 2). Development of a prototype and verification of the utility of output data. Development of a software to control the MEMS. Creating a sample for the performance of limited tests (10/12 trials) on the piste. Correction of any software errors.
- ▶ Resistance test with the production of 200/250 samples to be given to one nation for a period of at least 6 months (preferably an entire season). Correction and improvement of final software.

Opinion of the Rules Commission: In favour. The Commission agrees in principle and awaits a formal proposal from the SEMI Commission.

Proposals of the Refereeing Commission

The Referees Commission is proposing follow modifications

Proposal 1

Material Rules:

Modification m.27.3.1 / m.32.5.4

FOIL

m.27.3.1

3. The electrical contact between the conductive jacket and the bib of the mask must be ensured by means of a white-colored or clear covered wire with two crocodile clips. The wire must be attached to the bib of the mask with one crocodile clip and to the jacket with the other. This wire must be between 30cm and 40cm long. ~~In the case of a coiled wire, the maximum length of the free cable must not exceed 25cm with a tolerance of +/- 5cm.~~ A coiled mask wire is not allowed.

Opinion of the Rules Commission: In Favour.

Proposal 2

SABRE

m.32.5.4

4. The **electrical contact** between the conductive jacket and the mask must be ensured by means of a wire and one or two crocodile clips. ~~In the case of a coiled cable, the maximum length of the free cable must not exceed 25 cm in length, with a tolerance of ± 5 cm.~~ A coiled mask wire is not allowed.

Reason:

This wire is covering at times during the match a considerable part of the valid target.

Opinion of the Rules Commission: In favour but with the same wording as for foil:

4. The electrical contact between the conductive jacket and the mask must be ensured by means of a white-colored or clear covered wire with one or two crocodile clips. The wire must be attached to the mask with one crocodile clip or by soldering and to the jacket with a crocodile clip. This wire must be between 30cm and 40cm long. A coiled mask wire is not allowed.

Proposal 3

Technical Rules:

t.18.5. The order 'Halt!' is also given if the play of the competitors is **dangerous, confused, or contrary to the Rules**, if one of the competitors is **disarmed** or **steps off the piste**, or if, while retiring, he approaches too near the spectators or the Referee (cf. t.26, t.54.5 and t.73.4.j).

At foil it is forbidden, during the course of fencing, to advance the shoulder of the non-sword arm in front of the shoulder of the sword-arm (cf.t.19). Any hits scored by the fencer at fault while committing this offence will annulled.

Opinion of the Rules Commission: In favour with the following wording:

Technical Rules:

t.18.5. The order 'Halt!' is also given if the play of the competitors is **dangerous, confused, or contrary to the Rules**, if one of the competitors is **disarmed** or **steps off the piste**, or if, while retiring, he approaches too near the spectators or the Referee (cf. t.26, t.54.5 and t.73.4.j).

At foil it is forbidden, during the course of fencing, to advance the shoulder of the non-sword arm in front of the shoulder of the sword-arm (cf.t.19). If a competitor does so he is liable to incur the penalties enumerated in Articles t.114, t.116, t.120. Any hits scored by the fencer at fault while committing this offence will annulled.

Proposal 4

t.120 cat 1: Reversing the line of the shoulders.

Reason:

- This modification would made more clear the decisions of the referee. It is mostly a "grey zone" and an interpretation whether the non-sword arm is covering the valid target.
- If the fencer is turning in the non-sword shoulder so in same time is not more visibly by the camera what he is doing with his non-sword hand.

For RC Claus Janka

Opinion of the Rules Commission: In Favour.

Deferred Proposals

1. Deferred proposal of the Hungarian Fencing Federation

Motivation:

It is merely a clarification of an existing rule, more precisely that the fencer must not be penalised by one meter unless he crosses the lateral boundaries of the piste with two feet.

t. 17.9

The return on guard, at a distance, for a **lateral exit of the two feet** may place the opponent committing the error on the other side of the rear line and lead to a hit.

Opinion of the working group 2015 (Rules, Refereeing, Promotion Commissions, Coaches Council, Athletes Commission) in charge of reviewing the proposal deferred in 2014:

The text proposed by the Rules Commission in English is preferable, but the English text will have to be adapted for application in French. The new French text proposed is the following:

If a fencer crosses the lateral boundaries of the piste, with one or two feet, he must be placed on guard at the correct distance, even if this means that he is placed behind the rear line and causes a hit to be awarded against him. (cf t.28, t.102).

Opinion of the Rules Commission: In favour of the proposal of the working group with the following wording in French and English:

Eng

If a fencer crosses the lateral boundaries of the piste, with one or both feet, he must be placed on guard at the correct distance, even if this means that he is placed behind the rear line and thus causes a hit to be awarded against him. (cf t.28, t.102).

2. Deferred proposal of the Russian Fencing Federation

Motivation:

Reducing the number of simultaneous attacks for sabre. Increasing the number of actions in order to make matches more spectacular.

t.17.

1. For foil and épée, ~~the~~ **The Referee places** each of the two competitors in such a way that the front foot of each is 2 metres from the centre line of the piste (that is, behind the 'on-guard' lines).

2. For sabre, the referee places each of the two competitors in such a way that the back foot of each is 2 m from the centre line of the piste (that is, in front of the "on-guard" lines).

Opinion of the working group 2015 (Rules, Refereeing, Promotion Commissions, Coaches Council, Athletes Commission) in charge of reviewing the proposal deferred in 2014:

The object of this proposal is to reduce simultaneous attacks at sabre. An ad hoc commission must be nominated by the Executive Committee as soon as possible, with the task to obtain statistics regarding simultaneous attacks during the rest of the 2015-16 season.

The working group is in favour of the proposal to organise tests, by introducing the rules proposed by the Russian Federation as temporary rules for all categories at sabre, men and women, during the period from the start of the 2016-2017 season until 31 December 2016.

The ad hoc commission will study the tests through comparisons with the statistics from the previous season. It will deliver its opinion at the end of 2016 to the Executive Committee, which will decide if the rule will be applied for the rest of the 2016-17 season.

The correct numbering of the articles in the proposal is t.17.2.a and t.17.2.b

Opinion of the Rules Commission: Not in favour. The new sensor should be introduced before any more reforms are tried in sabre.

3. Deferred proposal of the Swedish Fencing Federation

Adjustment of calculation procedure for individual and teams world ranking during the year following the Olympic Games (o.83 and o.84)

Motivation:

Participation in the Olympic Games is very limited. However, the multiplying factor for points attributed during the Olympic Games is of 3 for the individual competition and 2 for the teams competition (World Cup: 1; Grand Prix: 1.5; and World Championships: 2). This leads to an imbalance in the world rankings during the year following the Olympic Games, which is not corrected prior to the next World Championship, which can have even more lasting consequences on the ranking.

Opinion of the working group 2015 (Rules, Refereeing, Promotion Commissions, Coaches Council, Athletes Commission) in charge of reviewing the proposal deferred in 2014:

The working group recognises that there is a problem with the official FIE rankings during the season following the Olympic Games. In particular, in all Olympic teams competition participation is very low, which gives too much protection to participating teams and causes immobility in the rankings during the season following the Games.

The intention of the proposal formulated by the Swedish Federation to find a solution to this problem has also been mentioned by the Athletes Commission. However, the Athletes Council and the working group do not consider it appropriate to entirely cancel the results of the Games in the rankings of the new season.

The working group proposes that the multipliers be adjusted in order to reduce the consequences of the limited participation to the Games, and to improve the initial rankings of the competitions during the new season following the Olympic Games. The opinion of the working group is that the following multipliers are suitable:

The group proposes the following text in the Rules:

o.83.2 Individual ranking

b) The different competitions are attributed the following multipliers

Competition	Individual competitions
Olympic Games	2

World Championships	2
Grand Prix	1.5
Zonal Championships	1
World Cup	1

~~b) Points obtained in an individual A Grade World Cup competition have a multiplying factor of 1.~~

~~c) Points obtained in a Grand Prix competition of the FIE and a Zonal Championship are multiplied by a factor of 1.5.~~

~~d) Points obtained in the individual events of the Senior World Championships and in the Junior World Championships are multiplied by a factor of 2.5.~~

~~c) e) Points obtained in the individual events of the Olympic Games are multiplied by a factor of 3.0.~~ At the **Olympic Games**, the 4th is awarded ~~54~~ **36** points.

~~d) f)~~ Only fencers who have **actually participated** in a direct elimination table can receive any points.

Opinion of the Rules Commission: In favour of the proposal of the working group with the following change: The multiplier for individual zonal championships should be 1,5.

4. Deferred proposal of the Swedish Fencing Federation

o.84.2 Team scale of points

b) The different competitions are attributed the following multipliers

Competition	Multiplier
Olympic Games	1.5
World Championships	1.5
Zonal Championships	1
World Cup	1

~~b) For the World Team Championships, the points indicated above are multiplied by two.~~

~~c) Points obtained in a Zonal Team Championship have a factor of 1.0.~~

Opinion of the Rules Commission: In favour of the proposal of the working group

5. Deferred proposal of the Swedish Fencing Federation

Creating a cycle for the Olympic programme, based on the principle of gender equality and equality between the different weapons (o.48.1)

Motivation:

The situation in which there are ten gold medals attributed to fencing at the Olympic Games continues since 2004, and there is no sign that the number of medals will increase. To this day, the Congress has taken decisions in what regards the Olympic programme three years in advance (for example, in November 2013 for the Olympic Games in Rio in 2016). It is clearly too late to allow athletes and national federations to prepare and plan their activities in a structured manner.

Consequently, it is desirable to clearly establish in our rules the Olympic programme cycle, in order to ensure stability and equity between the genders and the different weapons.

The Swedish Fencing Federation proposes the continuation of the cycle applied for the Olympic Games in Beijing, London, and Rio de Janeiro.

Opinion of the working group 2015 (Rules, Refereeing, Promotion Commissions, Coaches Council, Athletes Commission) in charge of reviewing the proposal deferred in 2014:

The working group is in favour of the proposal, but there seems to have been a misunderstanding concerning the structure of the proposed cycle. This proposal provides balance between the weapons and the genders in the current situation, even if it is very important to obtain two additional medals. The working group proposes the following cycle:

Programme of competitions

o.48

1. The programme of fencing events at the **Olympic Games** currently comprises 10 events. Given that the situation does not allow for organising 12 events, the programme of team events at the Olympic Games varies so that two weapons per team are not included during each Olympic year. For events not included in the Olympic programme, the FIE will organise World Championships.

The team competitions cycle at the Olympic Games will be:

Olympic Games 2016: Men's foil, men's épée, women's épée, women's sabre. (In the case of women's foil and men's sabre, the FIE will organise World Championships.)

Olympic Games 2020: Women's foil, men's épée, women's sabre, men's sabre. (In the case of men's foil and women's épée, the FIE will organise World Championships.)

Olympic Games 2024: Women's foil, men's foil, women's épée, men's sabre. (In the case of women's sabre and men's épée, the FIE will organise World Championships.)

The cycle described above is continued for the following Olympic Games (2028, 2032, ...)

Any change to the above cycle or to the number of events must be approved by the Congress.

Opinion of the Rules Commission: In favour of the proposal of the working group

Proposals from the Veterans to Council to the Executive Committee

Proposal 1

o.87

1. The organisers must submit the programme of events to the Executive Committee for its approval.
2. The programme must be arranged in such a way to allow any fencer to participate to all weapons and team events must be held on a day following the championships of the three categories of each weapon.
3. No changes of days are allowed for each competition, after the release of the programme.
4. Each competition must be held in one single day, possibly avoiding long inactive time along the progress of it.

Opinion of the Rules Commission: In favour of the proposal with the following wording (identical to the opinion of the Veteran Council):

o.87

1. The organisers must submit the programme of events to the Executive Committee for its approval.
2. The programme must be arranged in such a way to allow any fencer to participate to all weapons. Team events must be held on the day following the last championship of the three categories of each weapon.
3. No changes of days are allowed for each competition, after the release of the programme.
4. Each competition must be held in one single day, avoiding long inactive time along the progress of it.

Proposal 2

o.88 Entries for competitions

1. Entries must be sent to the organisers by the competitors' national federation. Numerical entries shall be sent not later than one month before the beginning of the championships; entries by names not later than two weeks before.
2. However, until two days before the competition at noon (local time), fencers may be added by their national federation after payment to the Organizing Committee of a penalty equal to 50 % of the registration fee.
3. Entries for team championships must be forwarded to the Directoire technique not later than 4.00 pm (local time) of the day before the competition.

Opinion of the Rules Commission: In favour of the proposal with the following wording (identical to the opinion of the Veteran Council):

o.88 Entries for competitions

1. Entries must be sent to the organisers by the competitors' national federation. Entries shall be sent not later than one month before the beginning of the championships.

2. However, until two days before the competition at noon (local time), fencers may be added by their national federation after payment to the Organizing Committee of a penalty equal to 100 % of the registration fee.

3. Entries for team championships must be forwarded to the Directoire Technique not later than 4.00 pm (local time) of the day before the competition.

Proposal 3

o.89

At the Veterans World Championships, entries for the individual events are limited to four fencers in each category per gender, per weapon and per nation. The names must be consistent with FIE licences.

Opinion of the Rules Commission: In favour.

Proposal 4

o.90 Composition of the pools for individual championships

When drawing the pools, the Directoire Technique will take into account the following orders of strength:

1. The 64 highest ranked from the addition of the results in the two last years Championships, irrespective of age category changes;
2. The 64 highest ranked in the last Zone championships, irrespective of age Category changes, if available; the order of Zones is based on the number of athletes of each category present in the last World Championship from each Zone.
3. All other fencers in order of age, starting from the youngest.
4. The allocation of fencers in the pools must be made in such a way as to place fencers of the same nationality, as far as possible, in different pools, by moving them down the ranking as necessary.
5. If in any category there are fewer than ten competitors, the competition is held as a poule unique.
6. If in any category there are fewer than 6 competitors, they will fence with an adjacent age category. A separate ranking for this category will be extrapolated from the other category at the end of the competition.
7. If in any category there is only one competitor, the event in that category is cancelled.
8. No fencer is eliminated after the poules, all enter into direct elimination.

o.91 Duration of the matches

The direct elimination bouts are for 10 hits or end when two periods of three minutes, with one minute rest between the periods, have passed. As an exception, at sabre, the first period ends either at the expiry of the three minutes or when one of the fencers has scored five hits.

Opinion of the Rules Commission: In favour of the proposal with the following wording (identical to the opinion of the Veteran Council):

o.90 Composition of the pools for individual championships

When drawing the pools, the Directoire Technique will take into account the following orders of strength:

1. The 64 highest ranked from the addition of the results in the two last years Championships, irrespective of age category changes;
2. All other fencers in order of age, starting from the youngest.
3. The allocation of fencers in the pools must be made in such a way as to place fencers of the same nationality, as far as possible, in different pools, by moving them down the ranking as necessary.
4. If in any category there are fewer than ten competitors, the competition is held as a poule unique plus direct elimination.
5. If in any category there are fewer than 6 competitors, they will fence with the lower age category. A separate ranking for this category will be extrapolated from the combined categories final rankings at the end of the competition.
6. If in any category there is only one competitor, the event in that category is cancelled.
7. No fencer is eliminated after the poules, all enter into direct elimination.

o.91 Duration of the matches

The direct elimination bouts are for 10 hits or end when two periods of three minutes, with one minute rest between the periods, have passed. As an exception, at sabre, the first period ends either at the expiry of the three minutes or when one of the fencers has scored five hits.

Proposal 5

o.92. Team championships

1. Participation

Each country can enter one team per sex and per weapon, thus giving place to 6 competitions.

2. The rules for team championships are applicable with the following exceptions:

3. For each weapon, the teams are constituted by three fencers of the same nationality, one from category "A", one "B" and one "C" with or without one reserve for each category. A team cannot begin the match if it is not complete.

4. In the case of a team being short of one fencer in a weapon the team may use a fencer who has competed in the individual championships at another weapon or that did not participate in the individual championships, but his/her ranking will be deemed to be the last ranking at that weapon plus 1.

5. The teams are placed in the poules according to the ranking of the three fencers in the individual championship, the highest place for those having the lowest total. Fencers that did not participate to the individual championship are ranked with the worst result plus 1.

6. Each team may ask to substitute a fencer before the start of the bout, except in case of injury duly recognized by the Medical delegate, when the substitution can be immediate. There can be only one replacement per match.

7. The fencer who has been replaced because of an injury may not fence again during that match.

If both a fencer and the reserve, if any, are forced to retire, or if a fencer is excluded, their team has lost the match.

8. The relay system is always applied. The three fencers of a team fence against the opponent of the same category. Each fencer fences twice his/her opponent for a total of 6 bouts. The bouts are for 5 hits (5-10-15-20- etc.); the maximum time for each bout is 3 minutes.

9. The team that first reaches the maximum score of 30 hits, or that which has scored the greatest number of hits after the expiry of regular time, is the winner.

10. The order of categories for each match is established by drawing lots with the presence of the team captain.

11. The competition consists of a round of poules of 3 or 4 teams, in which all the teams participate, and a direct elimination phase for a maximum of 16 teams, the other teams will be classified according to their place after the round of poules.

12. If there are 3, 4 teams: the teams fence in a poule unique only and the ranking is as indicated in art. o.19, without direct elimination. If there are 5 teams, after an unique poule, a match for the 3rd and 4th places is held, then a match for the first place between the 1st and the 2nd.

Opinion of the Rules Commission: In favour of the proposal with the following wording (identical to the opinion of the Veteran Council):

o.92. Team championships

1. Participation

Each country can enter one team per gender and per weapon, thus giving place to 6 competitions.

2. The rules for team championships are applicable with the following exceptions:

a) For each weapon, the teams are constituted by three fencers of the same nationality, one from category "A", one "B" and one "C" with or without one reserve for each category. A team cannot begin the match if it is not complete.

b) In the case of a team being short of a fencer in a weapon the team may use a fencer who has competed in the individual championships at another weapon, but his/her ranking will be deemed to be the last ranking at that weapon plus 1.

c) The teams are placed in the poules according to the ranking of the three fencers in the individual championship, the highest place for those having the lowest total. All the fencers registered for the team event must be present at the piste before the start of the match.

d) Each team may ask to substitute a fencer before the start of the bout, except in case of injury duly recognized by the Medical delegate, when the substitution can be immediate. There can be only one replacement per match.

3. The fencer who has been replaced because of an injury may not fence again during that match. If both a fencer and the reserve, if any, are forced to retire, or if a fencer is excluded, their team has lost the match.

4. The relay system is always applied. The three fencers of a team fence against the opponent of the same category. Each fencer fences twice his/her opponent

for a total of 6 bouts. The bouts are for 5 hits (5-10-15-20- etc.); the maximum time for each bout is 3 minutes.

5. The team that first reaches the maximum score of 30 hits, or that which has scored the greatest number of hits after the expiry of regular time, is the winner.

6. The order of categories for each match is established by the referee with the captains on the piste prior to the match starting: The referee will “toss a coin” and the winning captain will select the first category in the order. The losing captain will select the second category.

8. The competition consists of a round of poules of 3 or 4 teams, in which all the teams participate, and a direct elimination phase for a maximum of 16 teams, the other teams will be classified according to their place after the round of poules.

9. If there are less than 6 teams, after a unique poule, a match for the 3rd and 4th places is held, then a match for the first place between the 1st and the 2nd.

Proposal 6

o.93 Referees

Refereeing Veteran World Championships is carried out by referees appointed by the Executive Committee of the FIE, selected by the Refereeing Commission on indication of the Organizing Committee. Fifteen of them shall be of at least eight different nationalities, being no more than two of each nationality; the other necessary referees shall be from the organizing country. In case of unavailability of sufficient national referees, they will be chosen by the Organizing Committee from nearby countries.

Referees' travel and board and lodging costs are paid by the organising committee who in return will receive all the entry fees, as stated in art. 6.2 of Administration Rules.

Participating countries must notify at least one month in advance whether they will either bring the required number of referees or pay the penalty, in order to allow enough time to the organizers to recruit other referees.

Referees must attend the refereeing meeting that takes place the day before the World Championships

Opinion of the Rules Commission: In favour of the proposal with the following wording (identical to the opinion of the Veteran Council):

o.93 Referees

Refereeing Veteran World Championships is carried out by referees appointed by the Executive Committee of the FIE, selected by the Refereeing Commission on indication of the Organizing Committee. Fifteen of them shall be of at least eight different nationalities, being no more than two of each nationality; the other necessary referees shall be from the organizing country. In case of unavailability of sufficient national referees, they will be chosen by the Organizing Committee from nearby countries.

Referees' travel and board and lodging costs are paid by the organising committee who in return will receive all the entry fees, as stated in art. 6.2 of Administration Rules.

Referees must attend the refereeing meeting that takes place the day before the World Championships.

Proposal 7**o.94** Invitations for international officials

1. Any proposed candidature for organising the World Championships must be studied at the venue concerned by a delegate designated by the Executive Committee, at the invitation of the candidate federation.
2. The organising committee of the World Championships, who will receive all the entry fees from the participating delegations, must, at their own expense, invite the following international officials (tourist-class return air fare, accommodation and daily allowances):
 - a) The President of the FIE or his representative, who presides over the World Championships and, in particular, controls the smooth running of the Directoire Technique.
 - b) **Four** members of the Directoire Technique appointed by the Executive Committee of the FIE, one of whom must belong to the organising country.
 - c) One member of the SEMI Committee, appointed by the Executive Committee of the FIE.
 - d) One member of the Refereeing Committee, appointed by the Executive Committee of the FIE.
 - e) One member of the Medical Committee, appointed by the Executive Committee of the FIE.

Opinion of the Rules Commission: In favour of the proposal with the following wording (identical to the opinion of the Veteran Council):

o.94 Invitations for international officials

1. Any proposed candidature for organising the World Championships must be studied at the venue concerned by a delegate designated by the Executive Committee, at the invitation of the candidate federation.
2. The organising committee of the World Championships, who will receive all the entry fees from the participating delegations, must, at their own expense, invite the following international officials (tourist-class return air fare, accommodation and daily allowances):
 - a) The President of the FIE or his representative, who presides over the World Championships and, in particular, controls the smooth running of the Directoire Technique.
 - b) **Four** members of the Directoire Technique appointed by the Executive Committee of the FIE, one of whom must belong to the organising country.
 - c) One member of the SEMI Committee, appointed by the Executive Committee of the FIE.
 - d) One member of the Refereeing Committee, appointed by the Executive Committee of the FIE.
 - e) One member of the Medical Committee, appointed by the Executive Committee of the FIE.

These official shall be preferably be selected from the same Zone of the Championships.

Proposal 8**ADMINISTRATIVE RULES****6.2 Amounts to be paid to the organisers:**

Subject	Euros
---------	-------

Individual entry fee Cadets, Juniors, Seniors, Veterans World Championships	55
Team entry fee Juniors, Seniors, Veterans World Championship	140
Referee fee Individual Veterans World championships	45
Referee fee Team Veterans World championships	45

Opinion of the Rules Commission: In favour

Proposal 9

HANDBOOK OF REGULATIONS

1.2 DESIGNATION AND EXPENSES

The Organisation Committee will pay for the expenses of the President of the FIE or his representative (plane ticket in economy class, lodging and per diem), in accordance with article **o.89** of the FIE Organisation Rules.

Officials

According to financial arrangements stipulated in Chapter 7 of the Administrative Rules of the FIE, the following officials are designated by the Executive Committee of the FIE and reimbursed by the organisers:

- three (3) members of the Directoire technique, including ~~one~~ **two** of the host country;
- one (1) delegate of the Refereeing Commission;
- one (1) delegate of the SEMI Commission;
- one (1) delegate of the Medical Commission.

These official shall be preferably selected from the same Zone of the Championships.

Opinion of the Rules Commission: In favour of the proposal with the following wording (identical to the opinion of the Veteran Council):

HANDBOOK OF REGULATIONS

1.2 DESIGNATION AND EXPENSES

The Organisation Committee will pay for the expenses of the President of the FIE or his representative (plane ticket in economy class, lodging and per diem), in accordance with article **o.89** of the FIE Organisation Rules.

Officials

According to financial arrangements stipulated in Chapter 7 of the Administrative Rules of the FIE, the following officials are designated by the Executive Committee of the FIE and reimbursed by the organisers:

- four (4) members of the Directoire technique, including **one** from the host country;
- one (1) delegate of the Refereeing Commission;
- one (1) delegate of the SEMI Commission;
- one (1) delegate of the Medical Commission.

These official shall preferably be selected from the same Zone of the Championships.

Minutes of the SEMI Commission meeting

30 July 2015

Meeting Opened at 11.12hrs

The representative from COMEX - Jacek Bierkowski welcomed the Commission members to Bucharest and wished us good luck in our meeting.

He suggested that the main areas for our consideration were

- Masks
- Blades
- Certification
- Sabre sensors

He informed us that the FIE President had the goals of obtaining 2 additional fencing medals for the Olympic Games in Tokyo and increasing the numbers and quality of our Referees.

Fie Sports Director Krisztian KULSAR addressed the meeting and said it was his pleasure to attend part of our discussions. His main points for our consideration were.

- Safety
- Re introduction of sensors for sabre which has already been approved by Comex on the premise that a new sensor will improve sabre fencing. So the SEMI Commission must promote development and implementation.

Item 1. The meeting then dealt with the Proposals for the 2015 Congress

See separate document. Appendix

Additional information

Proposal 13 Sabre sensor

The SEMI Commission are in favour of a new sensor for sabre. The technical criteria should be flexible to allow for innovation allowing several solutions to be examined. The exact figure of 500g should be ascertained by testing. Gamil ELZEFTAWI and Daniel DE CHAINE will co-ordinate this.

Item 2. Gudjon Ingi GESTSSON

i) Safety in sabre. Increased accidents in sabre; changed timing in scoring machines and stiffening of the blades, possible new point.

The change in timing for sabre should reduce the incidence of point hits and reduce the number of penetration incidents with the point.

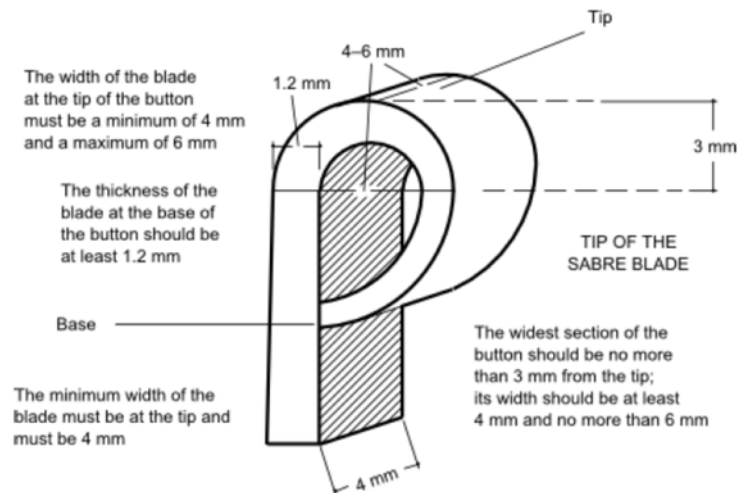

Fig 1 existing point – point width 4mm-6mm

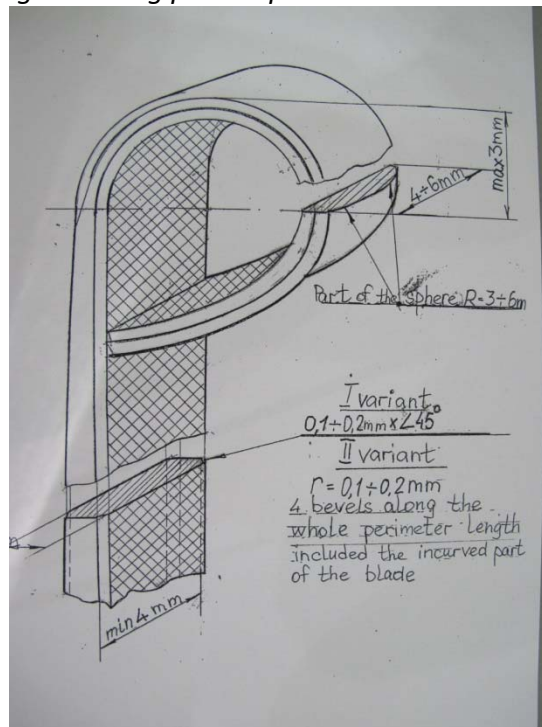

Fig 2 suggested new point – point width 5mm – 7mm plus chamfered edge Point surface area would remain unchanged

The SEMI Commission would like to approach manufacturers to produce some sabre blades for trial with a point as in figure 2.

*Also suggesting that the flexibility be changed from a minimum bend of 4cm to a maximum of 7cm to
6cm to a maximum of 9cm*

ii) Consider changing the rules for homologation, so that homologation is only given to equipment for a limited period of time. The manufacturer can apply for renewal, and SEMI decides if new tests are necessary.

This was discussed but no firm decision made.

SEMI Commission decided that the Legal Commission should be consulted for advice on sanctions that could be enforced on manufacturers who's equipment was found to be non-conforming to the material rules or where changes to had occurred after the original homologation.

Item 3. Janet HUGGINS

i) Source of Electricity for Apparatus. Suggested modifications to the rules pertaining to electrical judging equipment which is provided by the organisers

After discussion it was decided that because the majority of m.58 was no longer practical it should be rewritten to reflect how the electrical supply is now provided. This will be undertaken by ELZEFTAWI Gamil and a rule change proposed at the next opportunity.

ii) Unbroken sabre blades breaking a seam at the side of a PBT Sabre mask and the blade has penetrated inside the mask. Mask design now changed but should we advise fencers of potential problem with old style masks.

PBT have changed the bib on their sabre masks and attended the World Championships in Moscow replacing masks without charge.



iii) Rules m.28.1 and m.34.1 were changed regarding conductive jacket fit to entirely and without omission when in the on-guard position. However rule t.43.1 still shows the old wording is standing upright, is on guard and is in the lunge position and should be amended so that there is no conflict

It is understood that the Rules Commission is currently carrying out a revision of the rules to pick up such anomalies and it was agreed to bring this example to their attention.

iv) Change of wording suggested for m.25.3.c that the word clothing is replaced by the phrase. "Jackets, Breeches and Plastron" must be entirely in cloth able to resist a pressure of 800 Newton because Socks and gloves although clothing do not have to be 800N with the exception of the sabre glove which is specifically dealt with in m.33.1.

Agreed that the SEMI Commission would formulate a rule change proposal at the next opportunity

Item 4 VARALLO Giandomenico – **ITA**

i) Modernization of the white clothing (G Varallo & J Huggins)

Janet HUGGINS and Giandomenico VARALLO gave a presentation on the Modernization of Fencing clothing. There have been 3 meetings the set up meeting with The EPFL Team (The Ecole Polytechnique Federale de Lausanne), the second via SKYPE. The third in Lausanne which was attended by FIE personnel and representatives from the major manufactures of the raw materials and finished garments.

The focus of the group has moved towards the comfort of the athletes and providing education on the type of next to body wear that can improve heat dissipation and transpiration of moisture away from the skin.

In addition new technologies for the improvement are being investigated into the fabrics used, in order to lighten them but retain their strength perhaps by the introduction of "Nano particle" technology.

ii) Homologation data base

Giandomenico VARALLO informed the meeting that the data base for all FIE Homologated items to include Video Refereeing , Competition Software, Equipment and Clothing is now established.

We should now consider some system of regular re-testing starting with items with the oldest dated homologation and then run on a re-testing program on a continuing cycle.

- iii) The current Homologation Blade list shows the original homologation dates and the dates of the periodic re-tests.

The way that the present list is written has given rise to different interpretations of whether some blades are outside the period of the required re tests. Blades from StM Allstar and Viniti appear to be outside the re-test dates.

SEMI Commission requests a change in the schedule of required re-tests. It is suggested that tests should be made every 2 years with testing taking place between October and November, in order to standardize the re-testing procedure.

To start this process it was agreed that all dates up to now will be automatically be valid up to at least 1 January 2016.

Blades that have been tested before 2014 must be submitted for re-test no later than October/November 2016.

If the periodic test is not completed no blade after the due date can be deemed as homologated, however the blades manufactured before the required re-test date retain their homologation.

[Vote all in favour](#)

- iv) White clothing

At present there is no list on the FIE web site of homologated clothing.

Giandomenico VARALLO informed the meeting that he has collected together all the available information on homologated clothing in order to compile a list for publication on the FIE website.

There are some manufacturers who received homologation for their clothing before the "CEN" testing came into force and therefore do not have all the required documentation to comply with current FIE Homologation protocol.

It was agreed by the SEMI at this meeting that the clothing of these manufacturers would temporarily remain homologated and they would be given 2 years to complete full homologation of these items

v) Mask (see Comex decision)

Semen RIKHTMAN told the Commission that he believed that the Leon Paul “Contour Fit” and “Exchange Masks” were not Homologated and did not have the correct documentation and should receive an immediate ban and that only masks with a metal tongue and a fixed elastic back strap should be allowed.

Because of this were unable to take a vote on the Proposed Rule changes item no 10.

Janet Huggins gave a statement to the commission

She believed that although a homologation certificate cannot be traced for these masks there is a strong case of historic acceptance of them by the 2 previous heads of the FIE SEMI Commission.

Leon Paul have addressed the recent safety issues by the addition of a neck back strap and have changed to a double Velcro system for attaching the elastic back strap. These modifications were accepted last year and have been incorporated into the FIE Rules.

New allegations regarding the safety of these masks have been raised but no independent scientific analysis has been sought, the allegations seem to be based solely on personal opinions. I feel that substantive proof of any safety issues would need to be forthcoming before any action to ban these masks is undertaken. In fact the most recent example of a mask falling off was not a Leon Paul mask but one with a back tongue.

The masks we are informed have been CEN tested to level 2 requirements but the question of compliance to the FIE Rules has also been raised I would again refer to the historical acceptance.

The Commission agreed to delay the voting on this issue until the following day.

The morning session on Saturday 1 August 2015 was attended by Nathalie RODRIGUEZ, Krisztian KULSAR and Georgina USHER (Chief Executive Officer of British Fencing).

Georgina USHER gave a statement from Leon Paul saying they would prepare a dossier of information for the Commission.

After discussion it was agreed that within 2 weeks of this meeting a letter would be sent to Leon Paul Equipment Company informing them of the decision that their "Contour" and "Exchange Bib" masks must be submitted for Homologation.

The letter will contain the list of Test-Houses that are acceptable to the FIE. If they do not complete the homologation process by 31 May 2016 the masks "Contour Fit" and "Exchange Bib" will be banned from use at FIE Competitions from the 1 June 2016.

vi) m.25.4.c Specifications and testing procedures for covering for chest protectors implementation date September 2015 so urgent decision needed.

A report from Giandomenico VARALLO regarding the implementation of this was presented.

See Appendix

"The hardness of the outside of the material must be 20-30% hardness. This is the typical hardness of wet suit material for scuba diving (neoprene)"

After testing the variability and discovering some adverse properties of the suggested Neoprene, a more durable alternative was investigated. Giandomenico VARALLO has researched alternative coverings. The main manufacturers of the Chest Guards were approached and they can using the same mold as the plastic guard, create an outer covering of rubber, which would fit exactly over the existing chest guards.

This information has only recently been confirmed and further tests must be undertaken and it is not possible that the production of the chest guards by the manufacturers can be completed by the original start date 1 September 2015. The SEMI Commission would therefore suggest that a delay of at least 6 months before implementation and a possible delay until after the Olympic Games in Rio.

Consideration would also have to be given as to homologation of the chest guards.

vii)) Chrono during the last 10 seconds

The use of the clock changing to 10^{ths} of a second during the last 10seconds of the bout is now in use at FIE events and is working well. However at the recent World Championships in Moscow it was still not possible for the referee to operate the stop control button himself.

Item 5. Sarkis ASSADOURIAN

i) m.27.3. Revision regarding the coiled mask wire.

Previously discussed in Proposals and agreed to remove the use of coiled masks wires

ii) m.32.4. Revise wording for Foil and Sabre, the same mask wires are used we should use the same sentences.

Agreed that the wording used for m.27.3 should be the same for sabrem.32.4

iii) Annex A 3.2. Proposal: Suggested changes regarding the shape of plastron.

Agreed a diagram of the requirements of the plastron should be added to this section. DE CHAINE Daniel – USA will draft new diagram.

iv) m.57.3.b Suggested changes to podium dimensions

Suggested reduction in Max height of Podium for safety of fencers. Opinion of Referees and Medical Commission to be sought

Item 6. SEMI Standard 1.0 and applications

Semen RIKHTMAN presented his document on

Global Information System of Fencing Competitions

This introduces the united principle of organization and interacting of all information systems used during the holding of fencing competitions

The meeting agreed to accept this document.

Gudjon Ingi GESTSSON offered to read and do any minor corrections.

See Appendix

Item 7. Reports on the finished competitions.

The SEMI Commission Delegates
Presented their reports FIE Championships
See Appendix

Universiade

Pan-Am Games

World Championships Cadet & Juniors

World Championships Seniors

World Championships Veterans

During the presentation of these reports a question was raised about the use of "Kabcom" score units at FIE events because they did not have the required homologation. After the meeting the Homologation Certificate was found.
See Appendix

Item 8. Homologation of the competition software.

The meeting was addressed by Julius Kralik and Gudjon Gestsson regarding the homologation of competition software.

It was agreed that because this area of technology is constantly improving it would advantageous to maintain up to date versions of the systems.

To this end a new procedure requiring all manufacturers of system software to submit their systems for periodic re-homologation, should be introduced.

New or re-tested systems should take into account any changes in the rules and the handbook of specifications.

Item 9. Test list for homologation of video refereeing system.

During the World Championships in Moscow the Video Refereeing System Lammet OKO-F was retested. The system had previously been tested in St. Petersburg and following adjustments was now found to be in compliance with the program in the Checklist for Video Arbitrage.

It was passed by the SEMI and Refereeing delegate as compliant with the specifications required for certification.

Item 10. Instruction for the volunteers.

A new document compiled for the SEMI Commission entitled WEAPON CONTROL GUIDELINES see Appendix has been posted on the FIE web site under Documents of Commissions and Councils.

Item 11. Control of the individual body wires at FIE competitions.

Proposal from Semen RIKHTMAN

At FIE Competitions a large number of staff is required to check the body and mask wires at the initial weapon control stage. The fencer then uses the wires during training and this can result in the wires becoming broken or outside the electrical tolerances.

It is suggested that the checking of body and mask wires be discontinued at the initial weapon control stage. They would however be checked and marked in the call room.

Item 12. Preparation for RIO.

A presentation was given by Krisztian KULSAR and Giandomenico VARALLO on the preparations for the Olympic Games in Rio. They were able to show detailed drawings of the lay out of the venue and the competition set up.

Item 13. Designation of the delegates to competitions.

Olympic Games Rio – Technical Director - Giandomenico VARALLO

SEMI Delegates	Semen RIKHTMAN Janet HUGGINS Sarkis ASSADOURIAN
World Championships Junior and Cadets	Gamil ELZEFTAWI Tarek BEN REJEB Maria Wilda EBERL LOPEZ
Veteran Worlds	Gudjon Ingi GESTSSON
World Championships Team Rio Other Business	Daniel DE CHAINE

Item 14. Any

- i) Suggested new FIE Homologation logo
Semen RIKHTMAN presented a new design for FIE Homologation Label.

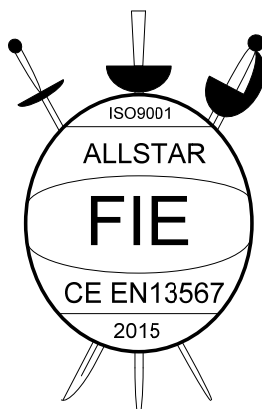

However after information from Giandomenico VARALLO concerning the acceptance of the label by the IOC it was suggested that the design be modified to remove the swords and the label must be circular not oval.

- ii) Chipping of clothing and homologated equipment

The Executive of the FIE has given approval for Electronic Chips to be inserted into Homologated items of equipment and clothing.

Prototype chips have been developed and during the World Championships in Moscow a meeting was held with representatives from Allstar, Leon Paul, Absolute and PBT. It's introduction is expected to be in 2017.

The manufacturers have been asked to forecast the number of each type of chip they will need. These will be purchased via the FIE and will be individually unique. Information for each chip will be stored on a data base held by the chipping manufacture.

The data can be read by means of a hand held scanner during weapon control.

- ii) CEN Regulation revisions due 2017

Semen RIKHTMAN suggested that FIE SEMI Commission should be represented on this body.

He proposed we put forward

The Chair of the SEMI Commission and the person responsible for the material tests at present this is Giandomenico VARALLO

- iii) An enquiry was received from Helen SMITH AUS regarding Country Logos on uniforms.

She asked if the Country Logo used on the fencing breeches could be embroidered on a piece of fabric which is then sewn onto the breeches. After a brief discussion the SEMI confirmed that this method is already used by several countries and provided the patch of fabric is well sewn (not leaving an uneven edge or trapping hazard) there should be no objection to this method.

- iv) A discussion was also held on the use of slip meters for measuring the pistes. It was confirmed that the FIE has purchased these and they will be available for use at FIE championships.

03/08/2015

PROPOSALS SUBMITTED TO THE SEMI COMMISSION 2015 CONGRESS

MODIFICATIONS OF THE STATUTES

Proposals of the Legal, Medical and PP Commissions and Women and Fencing Council

Proposal:

That the minimum representation of men and women on the FIE Executive Committee and all FIE Commissions and Councils should be raised from 20% to 30%.

Rationale:

In 2007 the Olympic Charter was amended to include, for the first time in history, the following:

"The IOC encourages and supports the promotion of women in sport at all levels and in all structures, with a view to implementing the principle of equality of men and women."
Rule 2, paragraph 7, Olympic Charter in force as from 07.07.2007

The International Olympic Committee (IOC) has publically committed itself to increasing the number of women occupying leadership positions within the Olympic Movement. Twelve years ago, in 2003, the FIE Congress took the decision to require minimum representation of 20% of men and women on the FIE Executive Committee and all FIE Commission.

In line with the commitment of the IOC and best practice in organisational governance, it is now time to increase gender balance in the FIE by increasing the minimum representation of men and women on all FIE Commissions and Councils to 30%.

Proposed changes to FIE Statutes:

Proposal 1

4.3.4: In order to secure the principle of equal treatment, women and men must be represented in overall view by at least ~~20~~ 30% of the elected members of the Executive Committee. If the 15 candidates who have obtained the most votes do not include at least ~~3~~ 5 persons of each gender, the Executive Committee will consist of the ~~3~~ 5 candidates for the Executive Committee who have obtained the greatest number of votes of the gender not otherwise being so represented and the ~~12~~ 10 candidates of the other gender who have obtained the greatest number of votes.

If there are less than ~~3~~ 5 candidates of either gender, that gender will be represented by the number of candidates put forward and the remainder of the Executive Committee will consist of the candidates of the other gender who have obtained the most votes.

Opinion of the SEMI Commission: In Favour

Proposal 2

4.4.4: If the 10 first members elected do not include ~~two~~ 3 members of each gender, the Commission will consist of the first ~~8~~ 7 members elected and the ~~two~~ 3 members of the other gender who are candidates for the commission and who have obtained the greatest number

of votes. If no candidate of either gender has offered herself/himself as candidates, the 10 candidates of different nationalities with the greatest number of votes are elected.

Opinion of the SEMI Commission: In Favour

PROPOSALS SUBMITTED TO THE SEMI COMMISSION 2015 CONGRESS

MODIFICATIONS TO THE RULES Proposals of the Executive Committed

Proposal 9

Motivation: Clarification of the text in order to avoid incidents due to the interpretation of the rules.

General conditions

m.25

The national uniform includes the socks, the trousers, the jacket, and the conductive jacket at foil and sabre. (Cf. m.28, m.34).

3 CHARACTERISTICS OF THE CLOTHING:

- e) There shall be only one national uniform per country, with the exception of the manufacturer's mark and the logo of the sponsors.

Application as follows: 1st of January 2016

Opinion of the SEMI Commission: In Favour

Proposal 10

Motivation: During the last two seasons, there have been several incidents involving masks which failed to properly secure the position of the mask on the fencer's head, in violation of the standard included in Annex 2.2.4 and of the urgent letter of the Executive Committee # 14 of 15 July 2014. The following modifications are therefore proposed, as well as the correction of a typing error in the French text.

m. 25.7 MASK:

- a) The mask must be made with meshes (space between the wires) of maximum 2.1 mm and from wires with a minimum gauge of 1 mm diameter. The mask must include ~~a safety strap at the rear~~ two different safety systems at the rear.
- f) The mask must contain ~~a horizontal safety strap~~ two different safety systems at the rear of the mask, with the two ends of ~~the strap~~ the straps of the systems firmly affixed

to the two sides of the mask. ~~This strap may~~ **These straps may** be elastic or of any other material that is approved by ~~the~~ **the** S.E.M.I. Commission.

Please refer to the examples in the drawings below:

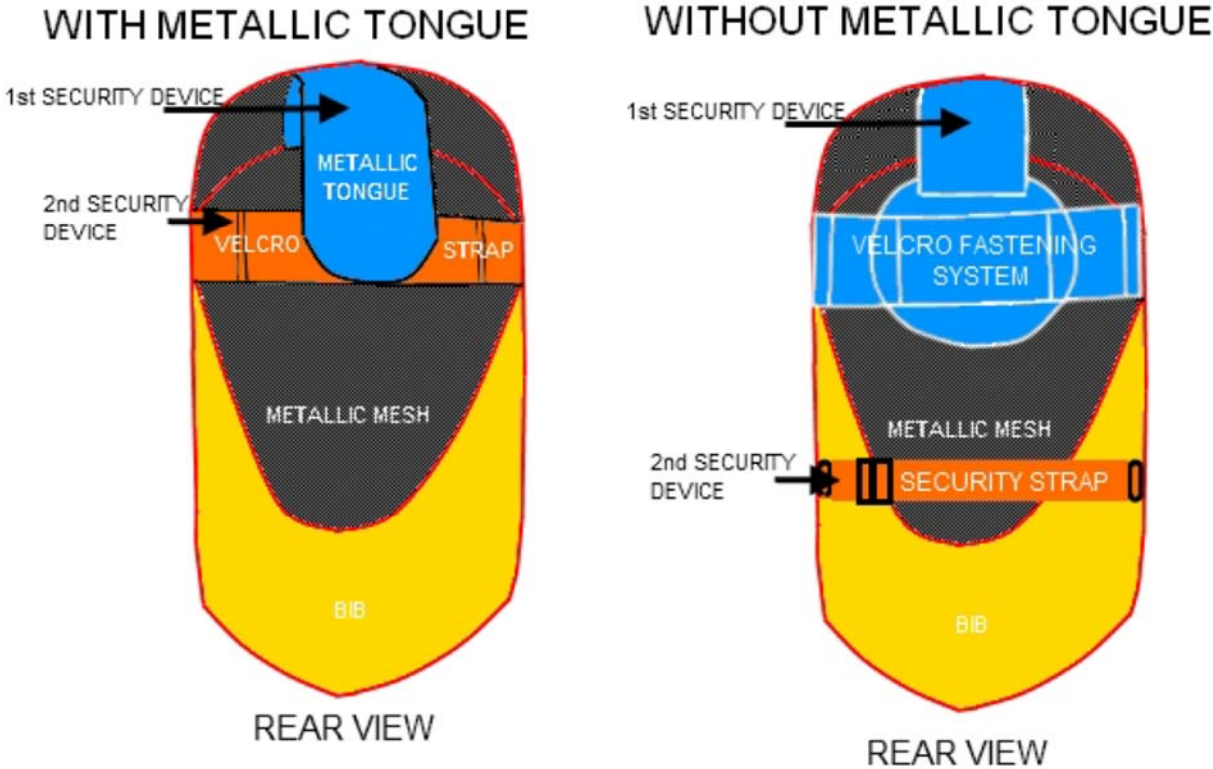

These images are only provided for information. When in doubt, the wording of the relevant text shall prevail.

EQUIPMENT

2. STANDARDS FOR THE MANUFACTURING OF MASKS

2.2

4 - Essential constituent elements

In particular, ~~the rear fixing device must ensure~~ **the rear fixing devices must** make sure that the mask is located in the correct position on the fencer's head and that it remains in a perfect position, even after blows or shocks.

Application as follows: 1st of January 2016

Opinion of the SEMI Commission: Did not vote on this Amendment- Because we are working with the European Standards working group for safety in sports in order to achieve a standardization of the rules concerning the mask.

Proposal 11

Motivation: During tests performed in 2009, it was established that the adequate blocking time allowing for spectacular actions, such as the parry and the riposte, is situated between 160 and 180 milliseconds. It has been, therefore, proposed to change the current time to 170 milliseconds.

ANNEX B

CHARACTERISTICS OF EQUIPMENT

C) SABRE

a) Principles

1) to 7), no change.

8) After a hit has been registered, a subsequent hit made by the other fencer will only be registered if it occurs within a maximum of ~~120~~**170 milliseconds** (± 10 ms tolerance).

9) and 10), no change.

Application as follows: vote during the 2015 Congress and, if the change is adopted, application starting with the season 2016-2017.

Opinion of the SEMI Commission: In Favour. But would suggest that from a technical point of view 180 milliseconds (± 10 ms tolerance) would be advisable.

Proposal 13

It would be helpful for the fencing world to consider a new sensor for the sabre, using available technologies.

The old sensor was a mechanical sensor (physical contact).

A small steel ball was held by two springs in a small metal pipe. When the hit reached its target with sufficient force (500 g), the ball moved and closed the circuit.

Numerous problems were immediately identified:

- If the movement was perfectly linear, the ball did not touch the pipe and did not close the circuit.
- The 500 g varied depending on the springs used by the manufacturer and their age, therefore, there could be differences from one weapon to the other.
- The greater the tilt of the blade, the less the sensor worked.

With the new, inexpensive technology derived from the automotive industry, we are able to start considering the production of a new electronic sensor using MEMS.

The **MEMS (Microelectromechanical Systems)** technology is the technology of very small devices; we are talking of the nanometric scale of nanoelectromechanical systems (NEMS) and of nanotechnology.

Today, the MEMS are mainly used to detect movement inside mobile elements, for example, air bags, smartphones, GPS. In sports, they are used in tennis, golf, and baseball.

The final product will be a square with sides of approximately 25 mm and 4/6 mm thickness. It will include a battery, one or two MEMS, and electronic circuits for power supply and the MEMS. It will be easy to place in the sabre guard.

The project will have to involve a specialised company and/or a university laboratory as the 1st trial. The development phase of the software is long and complicated, as is always the case when developing low level software.

The SEMI Commission may coordinate the sports aspects of the project (specification of data to be collected, and trials on the piste).

STAGES OF THE PROJECT

- ▶ Measurement of loads, limitations, speed, and energy absorbed during typical real attacks, using adapted sabres. HD video recording of attacks. Data analysis. Determining the minimum force of the hit (500 g) and possible decisions to prevent hits in certain specific directions (for example, rectilinear, with only the button).

- ▶ Selection of suitable MEMS (1 or 2). Development of a prototype and verification of the utility of output data. Development of a software to control the MEMS. Creating a sample for the performance of limited tests (10/12 trials) on the piste. Correction of any software errors.

- ▶ Resistance test with the production of 200/250 samples to be given to one nation for a period of at least 6 months (preferably an entire season). Correction and improvement of final software.

Opinion of the SEMI Commission: Vote In Favour that a new sensor should be developed. The technical Criteria should be flexible enough for innovation in it's development allowing several solutions to be examined. The exact figure of 500g should be ascertained by testing.

Proposals of the Refereeing Commission

The Referees Commission is proposing follow modifications

Proposal 1

Material Rules:

Modification m.27.3.1 / m.32.5.4

FOIL

m.27.3.1

3. The electrical contact between the conductive jacket and the bib of the mask must be ensured by means of a white-colored or clear covered wire with two crocodile clips. The wire must be attached to the bib of the mask with one crocodile clip and to the jacket with the other. This wire must be between 30cm and 40cm long. ~~In the case of a coiled wire, the maximum length of the free cable must not exceed 25cm with a tolerance of +/- 5cm.~~ A coiled mask wire is not allowed.

Opinion of the SEMI Commission: In Favour.

Proposal 2

SABRE

m.32.5.4

4. The **electrical contact** between the conductive jacket and the mask must be ensured by means of a wire and one or two crocodile clips. ~~In the case of a coiled cable, the maximum length of the free cable must not exceed 25 cm in length, with a tolerance of ± 5 cm.~~ A coiled mask wire is not allowed.

Reason:

This wire is covering at times during the match a considerable part of the valid target.

Opinion of the SEMI Commission: In Favour.

Global Information System of Fencing Competitions (Standard SEMI 1.0)

Introduction

The Present Standard introduces the united principle of organization and interacting of all information systems used during the holding of fencing competitions

The use of the present standard guarantees the compatibility of the sub-systems of different manufactures what allows the Organizers of the competitions to choose the best products and join them in the global information system of the competitions.

The use of the global information system at the competitions opens the new opportunities in modern covering of the competitions. Spectators can have an access to the latest, statistic and historic information while being at the venue or in any part of the world. The nodes of Global Information system, their functions and interaction mechanisms are described in the present standard.

The formulated demands for configurations of the Global Information system fencing competitions, its settings and functioning in the present standard are obligatory for all the FIE competitions. The service companies, providing service at the competitions can use their own technologies and solutions in this sphere if the two conditions are fulfilled. Firstly, they have to provide steady work of all the nodes of a Green level (see below) Global Information system fencing competitions according to the demands of the present standard. Secondly, their applied technologies and solutions should not disturb the work of the unfolded Global Information system of fencing competitions according to the present standard. Secondly, their applied technologies and the decisions should not disturb the work according the present standard.

Terms and Definitions

Node – (system or device) Global Information System of Fencing Competitions

Master – The Main Apparatus on the piste

Master Status– the formal description of the current status of the bout which the apparatus keeps at each moment of the time. Master Status includes:

- Piste number;
- Weapon: epee, foil, sabre;
- Information about the participants (last names, country codes/regions/clubs e.t.c.);
- Bout scores;
- Status of the bout: no participants, non-activated, activated, finished;
- Status of the bout timer (time of the bout)
- Bout timer is on/off;
- Type of the timer value: bout; pause: medical pause;
- Duration of the round by default;
- The meaning of the lamps (colored and white ones)
- Cards: yellow, red, black;
- Meaning of the priority;

Number of the requested video replays by athlete/coach

Master Status can include additional information which is defined by the information/service opportunities of the apparatus and the protocols of their interaction.

Action on the piste – an action which leads to the changing of the Master Status. The list of the most important actions requiring a special processing is in Appendix C. Important events on the piste.

Slave – an additional apparatus or other device which repeats the actions on the piste for spectators (e.g, lamps repeaters or stands with score, remote timers). Slave connects to the Master and receives all the information about the events on the piste from it.

Additional devices(additional devices on the piste)– devices or systems which are connected directly to the main apparatus (Master) and receive data directly from it (without use of any intermediate nodes). As the additional devices it is recommended to use only those devices and systems where the efficiency of receiving the Master's condition is critically important for the athletes on the piste and the referee.

Additional devices include, for example, slave, video refereeing system, e,t,c,

Additional devices can be connected to the apparatus, directly to the Master (e.g., via RS-485 interface) and through network circuits of Global Information System Fencing of Competitions (e.g, by protocol UDP/TCP).

Video Referee – video refereeing system is on the most important additional devices of the piste.

Scoring machines Server – system which joins all the main apparatus (Masters) and provides communication between them and other Nodes in a real-time mode.

Management of fencing competition – homologated FIE program-apparatus set which manages the competitions, forms the lists of participants, groups, classification, protocols of the bouts, reports e.t.c. Besides, Management of fencing competition forms official results of the competitions.

Manager(s) – node with Management of fencing competition software.

Server of the results – system of distribution of the current status of the competitions between nodes. Server of the results of Green and Yellow levels provide the information about the tournament in a real-time mode. It saves and distributes the information about the participants (lists, photos, pictures with the flags, e.t.c), lists of the groups and tables, current status of all the bouts at all the pistes; intermediate and official results, e.t.c.

Local information service – is an open web-server (or other service) for receiving the full information about the tournament for spectators through public network of the competitions.

Information screens – information screens at the pistes and at the arena, projector screens, e.t.c. Information screens – are used for the direct and visual informing of the spectators at the arena.

Live – is a system of direct video or text streaming of the results of the competitions to the Internet (to the remote public resources).

Weapon control information system (Weapon control) – information system of weapon control Zone.

Client – is a system or a device which is registered in the server (server of hits registration or at the results server) in order to get the information about the situation on the pistes or the results of the competitions in a real-time mode.

Abstract commands (commands) - general commands which are used during organization of communication of several nodes. The name and characteristic of the command are indicated while giving the abstract command. Instructions on its type and possible values are indicated for each parameter. All the protocols (Cyrano 2.0, USNP 1.0 and future ones) must implement the mentioned abstract commands. The list of the all using abstract commands see in Appendix B. Abstract commands.

Abstract description of the interaction mechanism¹ – general description of the order of interaction of different nodes with the use of the abstract commands.

Retransmission of the command – sending of the given abstract command from one Node to another one without the changing of the content.

Activation of the bout Активация боя – a special operation with the buttons of the apparatus (Master) which referee presses. The performance of this operation means that the referee has checked the correctness of the last names of the participants and their allocation on the pistes.

Request for ending the of bout Запрос на завершение боя – a special operation with the buttons of the apparatus (Master) which the referee presses. The performance of

this operation means that the referee has checked and confirms the status of the apparatus with the actual result of the bout.

Deactivation of the bout -Деактивация боя – a special operation with the buttons of the apparatus (Master) which the referee or technician performs. The performance of the current operation means that it is necessary to set the apparatus in the initial position which it had before the activation of the bout¹.

¹ The current operation is performed when the activation of the bout had taken place and later it was known that it was necessary to make changes in the indicated pairs. E.g. to swap the athletes..

Structure of the Global Information System Fencing Competitions

Structure of Global Information system fencing competitions is shown on the scheme:

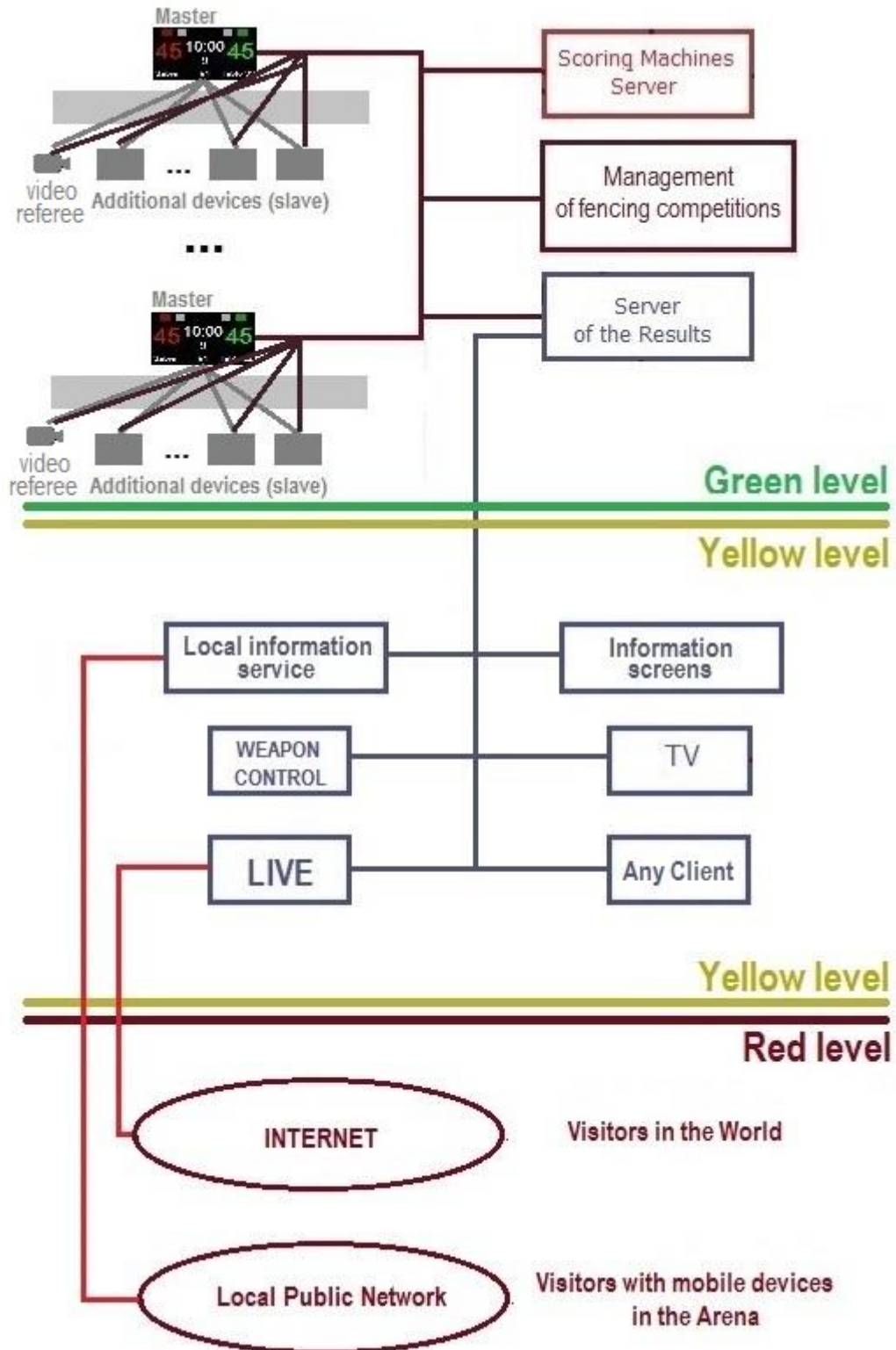

Global Information System of Fencing Competitions is divided into three part in order of importance.

Green Level consists of the devices and systems, reliable service and intercommunication between them are of critical importance for holding of the competitions.

The Green Level includes:

- The main hits registers (Master) of all the competition pistes;
- Additional devices (repeaters of signalization, video refereeing system, e.t.c.) on all the pistes;
- Server of hits registers;
- Secretarial server (Management of fencing competition)
- Results Server.

Only the systems having FIE Homologation, FIE (or SEMI) recommendations of the use are allowed for connection at Green level.

All the Green level nodes must be unrolled at any FIE competitions.

The direct connection of the networks of the Green level to the Internet is not allowed.

Yellow level consists of the devices and systems which do not affect on holding of the competitions. Generally, on this level there are systems for informing spectators about the competitions. Besides, the extended systems of holding of the competitions as a Zone of weapon control information system are connected on this level.

All the devices of Yellow level can receive the information only from each other or from the Results Server. The direct connection of the systems from the Yellow level to the Green level (apart from the Results Server) is not allowed.

It is recommended to divide physically or logically the networks of Green or Yellow levels with the means of information protection (e.g.routers with inter-network screens function).

Only the systems having FIE Homologation, FIE (or SEMI) recommendations of the use, Organizers' of the competitions recommendation with consent of TD and SEMI

The nodes of the Yellow level are not necessary. The Organizers define the necessity of the use of one or another node.

The direct connection of the networks of Yellow level to the Internet is not allowed.

Red level - consists of the devices and systems of general use as public local networks or Internet.

The access of the systems and devices to the Red level is not limited.

The direct connection of the systems and devices of the Red level to the Yellow or Green level is not allowed. Any system or device from the Red level can be connected only to the system or device of Yellow level which must provide the protection of the information both on Yellow and Green levels from possible attacks from Red level.

Network configuration of the Global Information System of Fencing Competitions

All Global Information System of Fencing Competitions nodes are joined in a single local network based on the number of protocols TCP/IP.

Address space 172.20.x.x is used with the mask of sub-network (255.255.0.0).

The detailed allocation of IP addresses is given in **Appendix A. IP addresses map**

Master scoring machine and additional devices

One main apparatus (Master) providing hits registration and signalization should be placed on each piste.

Master should comply with all the requirements of FIE regulations on holding of fencing competitions. Besides, Master should comply with the additional requirements of the present standard.

Master is the Global Information System of Fencing Competitions nodes, i.e. it must provide the connection to Interface Ethernet (RJ-45). Master must realize the functional of a command of the number of the piste and provide the IP address according to the present standard.

Master must support the direct connection to itself through Interface RS-485 (slot - D-SUB-9F).

Any Additional device, connected to Master with the use of RS-485 interface must have both input and output with (slot - D-SUB-9F) interface. Any information which comes on the input of the device must retransmit on the output without any distortion. The delay between the arrival of any byte on input and its retransmission on output should not exceed 50ms.

Master must support the following protocols:

- for Interface Ethernet (RJ-45)
 - Cyrano 1.0.
 - Cyrano 2.0
 - USNP 1.0
- for Interface RS-485
 - USNP 1.0

Master must allow to perform the connections to itself only for the devices with IP 172.20.x.y, where x-is a number of the piste Master and $y \in \{1, \dots, 255\}$, and also Scoring machine Server. The direct connection to Master of the systems and devices with IP 172.20.0.y, где $x \in \{1, \dots, 255\}$ is not allowed.

The addressing of the Master to Server of the results(172.20.0.2:50100) is allowed in order to get the photos of the athletes, pictures of the national flags, composition of the groups e.t.c. to display the present information on all the information indicators (monitors, screens, e.t.c.). In that case Master acts as a Client for Server of the results. Mechanism of the current connection is described in "Server of the Results" chapter.

The connection of all other IP addresses to Master is categorically prohibited. The present ban must be implemented in Master software.

Master must pass the time of the bout within the accuracy of cent second.

Master must realize the option of manual correction of the timer by a referee, including centiseconds.

Master must realize the mechanisms of activation, deactivation and ending of the bout. The current events must be displayed in its condition.

Independently whether or not the Master has indicators for displaying the names of the athletes it must keep (in its internal storage) the received data from the Server and include them in its condition.

Master must realize the option of calling of the technician, doctor, video refereeing system specialist and TD representative on the piste according to the protocols of Cyrano and USNP.

Master must realize the following functioning mode with Global Information System of Fencing Competitions:

- **Registration in the system** – a mode, when Master sends the request for registration in the system to Scoring machines Server;
- **Operating mode** – a mode, when Master sends its condition (command. INFO) to Scoring machines Server. Master sends its condition under any event from the list of specially registered events (see Appendix C. Important events on the piste).

The operating procedures of any mode is described in **Appendix D. Scoring machines Server**

Scoring machines Server

Scoring machines Server is the Global Information System of Fencing Competitions nodes and must be started on the node with IP 172.20.0.1.

Scoring machines Server is used to organize the interactions of the hits registers with the other nodes.

Scoring machines Server are provided by the Masters producer which are used on the piste for finals or color pistes.

Scoring machines Server keeps all the information about the arena configuration (activeness of the hits registers and their condition).

For more detailed information see Appendix D. Description of algorithms of work of Scoring machines Server.

Server of the results

Server of the results is the Global Information System of Fencing Competitions nodes and must be started on the node with IP 172.20.0.8.

On the Server of the results FTP and HTTP servers must be started additionally. . Whereas the FTP and HTTP folders must be set up in such a way that if using FTP it would be possible to change the composition of HTTP folders. The structure of the folders and their meaning is described in Appendix FTP and HTTP folders in the Server of the results.

Server of the results using at the present competitions is provided by the producer Management of fencing competition.

Server of the results must connect to the Server of hits registers and receives its condition, register its clients and sends them the condition of the registers.

More detailed information about the functioning of the mechanisms is given in Appendix E. The description of the algorithms of work of Server if the results

Management of fencing competition software

Management of fencing competition software is aimed to hold competitions and to form the official results.

Management of fencing competition software must undergo FIE homologation for accordance of FIE Regulations of holding of the competitions.

Management of fencing competition software must independently provide a storage and protection of the official results of the competitions. And also provide independent functioning from Global Information System of Fencing Competitions.

The breakdown of the Servers of Серверов Global Information System Fencing Competitions should not fail the work of Management of fencing competition software.

Management of fencing competition software must connect to the Global Information System Fencing of Competitions with use of devices with IP addresses 172.20.0.9-172.20.0.32

Management of fencing competition must provide the simultaneous service up to 8 independent competitions at the Arena.

Direct interaction between Management of fencing competition and Masters is not allowed

Direct interaction between Management of fencing competition and systems of Yellow and Red levels is not allowed.

Manager is responsible for control of coincidence of the information, sent to the piste..

Uploaded information must be full. E.g. there should be all the pairs in the table, even those which have qualified.

Video referee

Video refereeing is one of the most important systems out of the additional ones, installed on the piste.

Video refereeing system on the piste must comply with all the requirements of the Regulation of the competitions and regulations of the present standard.

Video refereeing system must be in Global Information System of Fencing Competitions nodes i.e. must provide the connection to Interface Ethernet (RJ-45) with the use of Cyrano 2.0 и USNP 1.0. protocols

Besides, video refereeing system can be connected to Master with the use of RS-485 interface and USNP 1.0. protocol.

Video recording should be in HD (1280x720) format, and starting with 2015 in FullHD (1920x1080) format.

Video record must contain the information about the names of the athletes, Master condition and the value of the geographical time of the place of holding of the competitions. The value of the timer of the time of the bout must be within the accuracy of centiseconds.

The value of the geographical time must be within the accuracy of 1000 fraction of the second.

Upon the end of each day the video refereeing system must form an archive disk with the video record of all the bouts recorded in a unified open format VideoRD 1.0 (for the description of the format see **Appendix G . Standart VideoRD 1.0. Format of the disk with video referee results.**).

The formed archive disk must be handed to the authorized body (appointed by FIE) which distributes it among the National fencing federations.

Control keys of the video refereeing system (buttons on a keyboard) must conform with the requirements (see **Appendix H. Videorefreee controls keys**).

Video refereeing system must provide to the Technical Directorate the monitor with the option of choosing and playing of video record of any episode from any out of 5 pistes.

In order to control the operator's work, the referee's monitor should display everything what the video camera records.

Video refereeing system must support the streaming to the Internet from all the five pistes with the quality necessary for TV broadcasting.

Appendix A. IP addresses map.

Range of the addresses 172.20.0.x (255 addresses) are used by nodes with the control systems only at the Green level. In this case, the addresses are::

- 172.20.0.1 – 172.20.0.32 – are used by the Servers and (Management of fencing competitions)
- 172.20.0.33 – 172.20.0.128 – reserved by SEMI and distributed on request from the Producers of the apparatus and software. No address from this range can be statically busy of a system or device without the SEMI consent.
- 172.20.0.129 – 172.20.0.240 – dynamically distributes by DHCP server. No address of the given range can be statically busy.
- 172.20.0.241 – 172.20.0.255 –free addresses.

Range of the addresses 172.20.1.x ... 172.20.64.x is reserved for the main hits registers (Masters) and additional devices on the pistes and can be used only by them. In this case, the addresses are:При этом адреса:

- 172.20.x.1 - are given only to Master hits registers on piste x присваиваются только Master фиксаторам уколов на дорожке x.
- 172.20.x.2 – 172.20.x.16 - are given only to hits registers - repeaters (slave) on the piste x.
- 172.20.x.17 – 172.20.x.32 - are given only to the refereeing systems, working on the piste x (e.g. video refereeing system).
- 172.20.x.33 – 172.20.x.48 - are given only to the system of live-streaming to the Internet from the piste x.
- 172.20.x.49 – 172.20.x.128 - are reserved for SEMI and distributes on request from the Producers of the apparatus and software. No address from this range can be statically busy of a system or device without the SEMI consent.
- 172.20.x.128– 172.20.x.255 - free for use

Signal table between the piste number and the used IP addresses on them is given below in the table **IP addresses map**.

Range of the addresses 172.20.65.x .. 172.20.128.x is reserved and can not be used without SEMI consent. Any producer of the systems or devices can address to SEMI and ask to allocate one or several IP addresses from the reserved range.

In case of the SEMI positive answer the allocated address (addresses) is reserved to the Producer and the notes are made in the IP addresses register.

Range of the addresses 172.20.128.x .. 172.20.254.x are dynamically distributes by DHCP server between nodes at the Yellow level. No address can be statically busy of the system or device.

Range of the addresses 172.20.255.x – is free for any use

Таблица. IP addresses map

Node name/type	IP addresses
----------------	--------------

Important nodes

Scoring Machines Server	172.20.0.1
Backup Scoring Machines Server	172.20.0.2
Free for special servers	172.20.0.3-172.20.0.6
Backup Server of the results	172.20.0.7
Server of the results	172.20.0.8
Devices with Management fencing competitions system	172.20.0.9 - 172.20.0.32
Reserved SEMI	172.20.0.33 - 172.20.0.128
Dynamically allocated by DHCP server	172.20.0.129 - 172.20.0.240
Free	172.20.0.241 - 172.20.0.255

Pistes

FINAL	172.20.60.1 172.20.60.2 - 172.20.60.15 172.20.60.16 - 172.20.60.32 172.20.60.33 - 172.20.60.48 172.20.60.49 - 172.20.60.128 172.20.60.129 - 172.20.60.255	Master scoring machine Slave scoring machines Referees systems (video referee) Live reserved for SEMI free
BLUE	172.20.61.1 172.20.61.2 - 172.20.61.15 172.20.61.16 - 172.20.61.32 172.20.61.33 - 172.20.61.48 172.20.61.49 - 172.20.61.128 172.20.61.129 - 172.20.61.255	Master scoring machine Slave scoring machines Referees systems (video referee) Live reserved for SEMI free
YELLOW	172.20.62.1 172.20.62.2 - 172.20.62.15 172.20.62.16 - 172.20.62.32 172.20.62.33 - 172.20.62.48 172.20.62.49 - 172.20.62.128 172.20.62.129 - 172.20.62.255	Master scoring machine Slave scoring machines Referees systems (video referee) Live reserved for SEMI free
GREEN	172.20.63.1 172.20.63.2 - 172.20.63.15 172.20.63.16 - 172.20.63.32 172.20.63.33 - 172.20.63.48 172.20.63.49 - 172.20.63.128 172.20.63.129 - 172.20.63.255	Master scoring machine Slave scoring machines Referees systems (video referee) Live reserved for SEMI free
RED	172.20.64.1 172.20.64.2 - 172.20.64.15 172.20.64.16 - 172.20.64.32 172.20.64.33 - 172.20.64.48 172.20.64.49 - 172.20.64.128 172.20.64.129 - 172.20.64.255	Master scoring machine Slave scoring machines Referees systems (video referee) Live reserved for SEMI free
Piste 1	172.20.1.1 172.20.1.2 - 172.20.1.15	Master scoring machine Slave scoring machines

	172.20.1.16 - 172.20.1.32 172.20.1.33 - 172.20.1.48 172.20.1.49 - 172.20.1.128 172.20.1.129 - 172.20.1.255	Referees systems (video referee) Live reserved for SEMI free
Piste 2	172.20.2.1 172.20.2.2 - 172.20.2.15 172.20.2.16 - 172.20.2.32 172.20.2.33 - 172.20.2.48 172.20.2.49 - 172.20.2.128 172.20.2.129 - 172.20.2.255	Master scoring machine Slave scoring machines Referees systems (video referee) Live reserved for SEMI free
....		
Piste N	172.20.N.1 172.20.N.2 - 172.20.N.15 172.20.N.16 - 172.20.N.32 172.20.N.33 - 172.20.N.48 172.20.N.49 - 172.20.N.128 172.20.N.129 - 172.20.N.255	Master scoring machine Slave scoring machines Referees systems (video referee) Live reserved for SEMI free
....		
Piste 59	172.20.59.1 172.20.59.2 - 172.20.59.15 172.20.59.16 - 172.20.59.32 172.20.59.33 - 172.20.59.48 172.20.59.49 - 172.20.59.128 172.20.59.129 - 172.20.59.255	Master scoring machine Slave scoring machines Referees systems (video referee) Live reserved for SEMI free
Other		
Reserved SEMI	172.20.65.x – 172.20.127.x	
Reserved for Wi-Fi access point.	172.20.128.x	
Dynamically allocated by DHCP server	172.20.129.x – 172.20.254.x	
Free	172.20.255.x	

SEMI COMMISSION

WEAPON CONTROL GUIDELINES

This set of Guidelines is divided into eight areas with four associated Appendices:-

1. Introduction,
2. Duties of the Weapon Control Team,
3. Location and Size of Weapon Control Areas,
4. Weapon Control Team,
5. Equipment required,
6. Submission and Return Protocols,
7. Documentation,
8. Security

Appendix 1 Example Plan of a Weapon Control Area

Appendix 2 Example of a Submissions and Returns Protocol

Appendix 3 Examples of Weapon Control Documents

Appendix 4 Examples of Weapon Control Report Documents

1. INTRODUCTION

What is weapon check?	A pre competition check <i>of</i>
What is controlled?	athletes' personal fencing kit <i>in order</i>
Why is it carried out?	to ensure a level playing field in relation to technical performance, legality and safety.

The authority to carry out a Weapon Check is provided in the 'Materials' section of the FIE Rules for Competitions.

Article m.36 states that for World Championships and the Olympic Games the weapon check must be supervised by the FIE SEMI Committee (Commission de la SIGNALISATION ELECTRIQUE du MATERIEL et des INSTALLATIONS). Article m.40 provides that these persons are to be appointed by the Executive Committee of the FIE. For other FIE Official competitions the Organising Committee appoint the persons responsible for this checking.

Article m.43 says that to carry out the checks properly, workshop teams of three people should be used and that at least three such teams should be in place. This rule, however only relates to the checking of weapons, as it states that one person checks the dimensions, the second does electrical tests and the third marks the weapons. There is no requirement as to the numbers needed for all the other control checks.

Organisers of events are required by article m.42 to provide the necessary testing equipment.

Article m.38.1 states that fencers are obliged to present themselves at the 'Weapon Checking Centre' at the prescribed time with the equipment that they intend to use. They are limited to four weapons, three body wires, two conductive jackets, two masks and three mask wires. The numbers of gloves, sabre overlays, plastrons, jackets, breeches and socks to be submitted are not dealt with.

Controls are, therefore, carried out on:-

- Weapons,
- Body wires and Mask wires
- Conductive metallic Sabre and Foil Jackets
- Conductive Sabre Gloves and overlays
- Conductive Sabre and Foil masks

With safety checks being carried out on:

- Masks (all weapons)
- Gloves (all weapons)
- Plastrons
- Jackets,
- Breeches and
- Socks

The remit to check for safety comes from Article m.25 where the requirements are that both equipment and clothing must provide the fencer with the maximum protection. It must not be possible for a fencer to be obstructed or injured by the equipment nor can there be any openings or buckles which could trap a blade.

2 DUTIES

A. WEAPON CONTROL

This control provides the fundamental checks for all the personal clothing and equipment of the competitors. The FIE Rules for Competitions specify the amount of kit that a competitor is allowed to submit and also what tests should be carried out on each item.

The staff of the weapon control will receive in the submitted kit which should be checked for conformance with technical, material and safety provisions.

If the kit complies it should be marked with a secure event specific mark. If the kit fails it should be labelled with the details of the problem/s. In addition, if the failure is fundamental i.e. the kit is irreparable, it should be permanently marked as such.

The control marks used should, as far as is possible, be unable to be easily copied or counterfeited. – See Section 9 to this document.

B. CALL ROOM

All of the personal equipment and clothing of each competitor that is presented in the Call Room should be examined again and all control marks should be verified.

Weapons, bodywires and mask wires should be checked to ensure electrical conformance. Foil points should be checked with the 500 g weight and if it is deemed necessary a 1 mm gauge to ensure that the travel is not excessive and epee points should be checked with the 750 g weight and the appropriate gauges (0.5 mm and 1.5 mm) to ensure that the travel is correctly set and that the larger gauge fits into the point.

All conductive material items should be examined and, in particular, conductive material jackets for foil and sabre should be checked to ensure that they cover the valid target when being worn by the competitor.

Once the clothing and equipment of a competitor has been checked that competitor should not be allowed to leave the Call Room. If a competitor does leave then any controlled clothing or equipment that they take with them should be re-examined on their return. Any equipment used for warm up between rounds should also be rechecked.

C. TEAM EVENT – PRE-BOUOT CONTROLS

Prior to entering the field of play, the clothing and equipment of all the members of each team will have been checked in the Call Room.

The equipment to be used by each team should be delivered to their position at the end of the appropriate piste where the duty control technician (armourer) will supervise its use. The first three bouts of any match will be fought using equipment controlled in the Call Room. However, at the end of each bout the equipment that has been used by the competitor should be rechecked.

Any equipment that fails controls during the match should be kept separately under the care of the control technician and should only be returned to the team at the end of the match or, if it is sent for repair after it has been through the Call Room controls again.

D. FIELD OF PLAY SUPERVISION

Two competent technicians (armourers) should be present on the field of play at all times when fencing is taking place. They should be there to assist referees in identifying problems that arise and should ensure that appropriate action is taken i.e. assisting to identifying if the problem is with the fencer's personal equipment, is with the field of play apparatus or the wireless equipment and that the appropriate technician is called.

E. OTHER DUTIES

1. Occasionally it may be necessary for the, control technician under the supervision of the SEMI COMMISSION delegate/s to carry out checks on suspect equipment that has be found either in weapon control or on the field of play. The armourer carrying out this work should have the ability and expertise to find, identify and report upon any corruption in the equipment and should be able to state whether any problem is accidental or deliberately induced. The weapon control team should have tools available to carry out this work.

2. The head of weapon control should be able to provide the SEMI COMMISSION representatives with all the necessary information to produce full statistics for the results of the tests that have been carried out. Totals should be available for each country, each weapon and each gender.

3. The SEMI COMMISSION representatives should be provided with all the information necessary to produce a report and also to be able to detail specific problems experienced in the weapon control, the call room and the field of play. This report should follow the guidelines outlined in the example report detailed in Appendix 3.

3 LOCATION AND SIZE

WEAPON CONTROL AREA

The weapon Control area should be located as near as is possible to the field of play as the weapon control technicians (armourers) will need to be able to move quickly and easily between the control room, call room and the field of play.

The Weapon Control room should consist of four areas, all of which can be made secure. These areas are a reception area, a storage area for submitted equipment and clothing (kit) which has yet to be controlled, the working area and a storage area for tested kit. A diagrammatic example of the layout for a weapon control area is attached in Appendix 1.

A. RECEPTION

The reception area should be large enough for four staff to receive in and confirm amounts of submitted kit prior to moving it into the pre-control storage area. A counter large enough to hold four fencing bags should be provided and there should be available space for competitors to queue with their kit. This area should also be used for returning controlled kit.

B. PRE-CONTROL STORAGE AREA

The pre-control storage area should be large enough to accommodate all of the kit for all of the competitors taking part in the largest day of competition. It is suggested that a simple shelving system could be provided to enable the weapon control staff to stack the submitted kit in numerical submission order.

C. WORKING AREA

The working area for testing the submitted kit should consist of two (possibly, three) working lines. Each line will consist of:

- a. an audit area where the team leader can check that the kit corresponds with the details contained on the submission documents;
- b. - for testing weapons - a gabarit fitted with (for World Championships and Olympic Games) an Eddy Current testing machine, electrical testing apparatus, a weighing machine, gauges for testing the dimensions of the points of the weapons and a machine that can be used for marking controlled weapons e.g. an etching machine or an engraving machine;
- c. - for testing body wires and mask wires – an electrical test meter, a measure of length and equipment for placing the control marks on kit that has passed the tests;
- d. – for testing conductive materials i.e. sabre and foil masks, sabre and foil conductive jackets and sabre gloves and overlays - an electrical test meter, a specialist 500 g weight, a mask probe and marking equipment for applying the control marks;
- e. – for checking epee masks, jackets, breeches, gloves and socks - an area where these items can be checked and marking equipment for applying the control marks;
- f. – an area with internet access for the SEMI COMMISSION delegates/s to work
- g. – an area with internet access for the head of the Weapon Control team to carry out the necessary clerical work associated with the control work; and
- h. – if possible, an area for catering provision should be provided in order that the staff can make refreshments whilst they work.

D. POST-CONTROL STORAGE AREA

This area should be of a similar size to the Pre-Control Storage Area and should be fitted out in a similar fashion.

CALL ROOM

The Call Room should be divided into four coloured areas which correspond to the coloured pistes in the field of play. Each area should have sufficient seating to accommodate two teams (of four competitors) plus the referee/s. This area should also be large enough to store the bags of kit specific to that piste.

Additionally, there should be an area where the control technicians (armourers) can carry out the kit checks.

Guidelines require that the Call Room area should be at least 40 square metres in size.

4 TEAM

The team that is required to perform the weapon control, field of play kit supervision, call room and, for team events, pre-bout testing should consist of a balanced membership of experienced and less experienced technicians (armourers).

The team should be headed up by an experienced control technician (armourer). The work to be carried out by the team will be done so under his/her direct control. The head of the weapon control team will report to the SEMI COMMISSION Representatives who will supervise all the activities of the team and ensure that best practice is achieved. The team should also be of mixed gender in order that female technicians can be available to work with those competitors who wish to have only female supervision.

A. WEAPON CONTROL

Three to four lesser experienced armourers or volunteers should be allocated to the role of receptionists. Their duties will be to receive in and accurately document submitted competitors' clothing and equipment (kit) and later to return tested kit to the competitors.

The Head of Weapon Control should divide the remaining members of the team into two (sometimes, three) sub-teams for the weapon control work. Each sub-team should have a team leader who will allocate the members of their team to their roles. Each team will be responsible for all the duties relevant to the total testing of submitted kit and will consist of at least seven members. The breakdown of the work will require three control technicians (armourers) to test and control mark the weapons – one to use the eddy current (courants de Foucault) machine and the gabarit, one to test that the weapons conform to the electrical testing standards and one to mark the weapons with the control marks. One control technician (armourer), possibly two, will be responsible for testing and marking body wires and mask wires. One member of the team will test and mark all of the conductive material equipment (sabre and foil masks, sabre and foil conductive jackets, sabre gloves

and overlays) and one control technician (armourer) will carry out checks on the clothing, gloves (other than conductive sabre gloves) and epee masks for safety, general conformity and condition and team uniform conformity. The team leader whilst supervising the team should also assist with testing.

Thus the Weapon Control team will consist, if there are to be two sub-teams of a minimum total of nineteen members – one head of weapon control, four receptionists, fourteen sub-team members. If there are to be three sub-teams this number will rise to twenty-six members.

It should also be remembered that during the tournament the Weapon Control team will have duties in other areas whilst Weapon Control checks are being carried out.

B. CALL ROOM

Once the Call Room is operative at least six armourers will be needed to carry out the pre-bout checks and to check that conductive jackets are an appropriate size.

Again, a SEMI COMMISSION delegate will supervise this activity.

C. FIELD OF PLAY

At least two armourers should superintend, with a SEMI COMMISSION representative, the field of play to ensure that the apparatus and competitors' personal equipment are operating correctly and that any problems are resolved as quickly as is possible.

The SEMI COMMISSION representative should direct both the control technician (armourers) and the apparatus supplier technicians as is necessary.

D. TEAM MATCH PRE-BOU CONTROL

A minimum of six but preferably eight armourers should be available to carry out the pre-bout controls for the last eight team matches held on the four coloured pistes. This number will reduce as the competition progresses to the later stages. These control technicians (armourers) will also ensure that the pre-controlled equipment is held securely for each team and, therefore, no one is able to tamper with this equipment.

5 EQUIPMENT

A. TECHNICAL EQUIPMENT

In addition to the equipment detailed below the Weapon Control team will need to have available a current copy of the FIE Rules for Competitions, lists of homologated equipment and details of all approved national uniforms and the associated logos.

Equipment needed:-

For Weapon Testing

- 3 x Gabarit (2+ a spare) – to check weapon dimensions,
- 2 x Eddy Current (Courants de Foucault) Machines – to check blade safety,
- 3 x Electrical testing devices (multimeters or testing machines such as Provi tester, Favero or PBT) – to check continuity and resistance,
 - Gauges for epee and foil points (sufficient to cover all pistes, call room and the weapon control)
- 3 x Gauges for sabre points and blade thickness,
- 3 x Weighing Machines (2 + a spare) – to check weapon weights,
 - Curvature guides (40mm x 10mm x 10mm) (sufficient to cover all pistes call room and weapon control),
 - 750 g Epee Test Weights (sufficient to cover all pistes, call room and weapon control),
 - 500 g Foil Test Weights (sufficient to cover all pistes, call room and weapon control),
- 3 x Etching Machines or Engraving machines (2+a spare) - to mark blades,
 - Sufficient permanent adhesive event specific labels to control mark weapon hilts
- 2 x Vernier or Micrometers - for point sizes.

For Body Wire and Mask Wire Testing

- 2 x Measures of Length – to check relevant lengths,
- 2 x Electrical testing devices – to check continuity and resistance,
 - Sufficient event specific secure marking cable ties or similar for control marking.

For Conductive Material Tests – Foil and Sabre Masks, Foil and Sabre Conductive Jackets, Sabre Gloves and Overlays.

- 2 x Electrical testing devices – to check continuity and resistance,
- 2 x 500 g conductive material test weights,
 - Control mark stamps using indelible ink.

For Mask Testing

- 4 x test probes (two for epee mask test station and two for foil and sabre mask test area) – only to be used to confirm failures,

For Clothing and Uniform Examination

- 2 x Measures of Length – to check dimensions of lettering, advertising etc.,
 - Control mark stamps using indelible ink.

A digital camera – to be used to record problem items of equipment etc.
Two way radios for ease of communication between team members.

MARKING EQUIPMENT (in the main already detailed above)

Etching or Engraving machines for marking the blades of weapons,
Secure event specific cable ties for marking body wires and mask wires,
Event specific stamps for marking all fabrics,
Indelible inks and stamp pads for use with the stamps,
Adhesive labels to mark weapon hilts and the secure cable ties if they are not event specific,
Labels to mark rejected equipment.

CALL ROOM

4 x Electrical testing meters/machines,
4 x 750 g weights for epee point testing (as detailed earlier),
4 x gauges for epee point testing (as detailed earlier),
4 x 500 g weights for foil point testing (as detailed earlier),
4 x curvature guides (as detailed earlier),
16 x Coloured Equipment Bags – preferably with wheels (4 x Red, 4 x Blue, 4 x Green and 4 x Yellow)

TEAM EVENT

The Call Room details are as above but armourers should remember to check that uniforms match.

For the Pre-Bout Checks:-

6 – 8 Electrical testing meters/machines
6 – 8 750 g Epee test weights
6 – 8 Epee Gauges
6 – 8 500 g Foil test weights
6 – 8 Curvature Guides

6 SUBMISSION AND RETURNS PROTOCOLS

A submissions and returns protocol should be produced prior to the start of weapon control activity. An example of such a protocol is shown in Appendix 2.

The protocol should be relevant to the tournament in question.

7 DOCUMENTATION

The tournament organiser should provide a suitable audit trail for the Weapon Control activity. This should be in the form of control documents:-

- a – numbered equipment submission sheets,
- b – bag numbering to match submission sheets,
- c – equipment failure sheets detailing specific problems,
- d – labels to attach to failed items,
- e – standardised weapon control statistical report form detailing results for equipment and clothing by country, gender and with overall totals,
- f – standardised weapon control report

Examples of documents a – d are detailed in Appendix 3 with examples of reports e and f contained in Appendix 4

8 SECURITY AND CONTROL MARKING

The entire Weapon Control area should be capable of being made secure and should therefore be equipped with lockable doors.

In addition a lockable store should be provided in order that all the control marking equipment can be locked away when the weapon control is closed or unmanned.

The equipment used for control marking should, as far as is possible, be unique in that it is event specific and should not easily be able to be copied or counterfeited.

For weapons, the marking on the blade should be etched or engraved and the marking on the hilt, usually on the inside surface of the guard, should be engraved or effected using non-removable adhesive labels.

For body wires and mask wires, the marking should be carried out using event specific security type cable ties. It is preferable that each of these carry a unique identifying number.

For all fabrics including masks, the marking should be provided by utilising a unique stamp and indelible ink.

These guidelines do not prevent suitable alternative systems of marking from being used. However a felt tip marker pen should not be used as any marks made are too easily copied.

WEAPON CONTROL AREA

GOOD OVERHEAD LIGHTING IS NEEDED TO ALL AREAS

ELECTRICAL SUPPLY: 12 Sockets (minimum)
 WiFi: Access points for W/C and SEMI

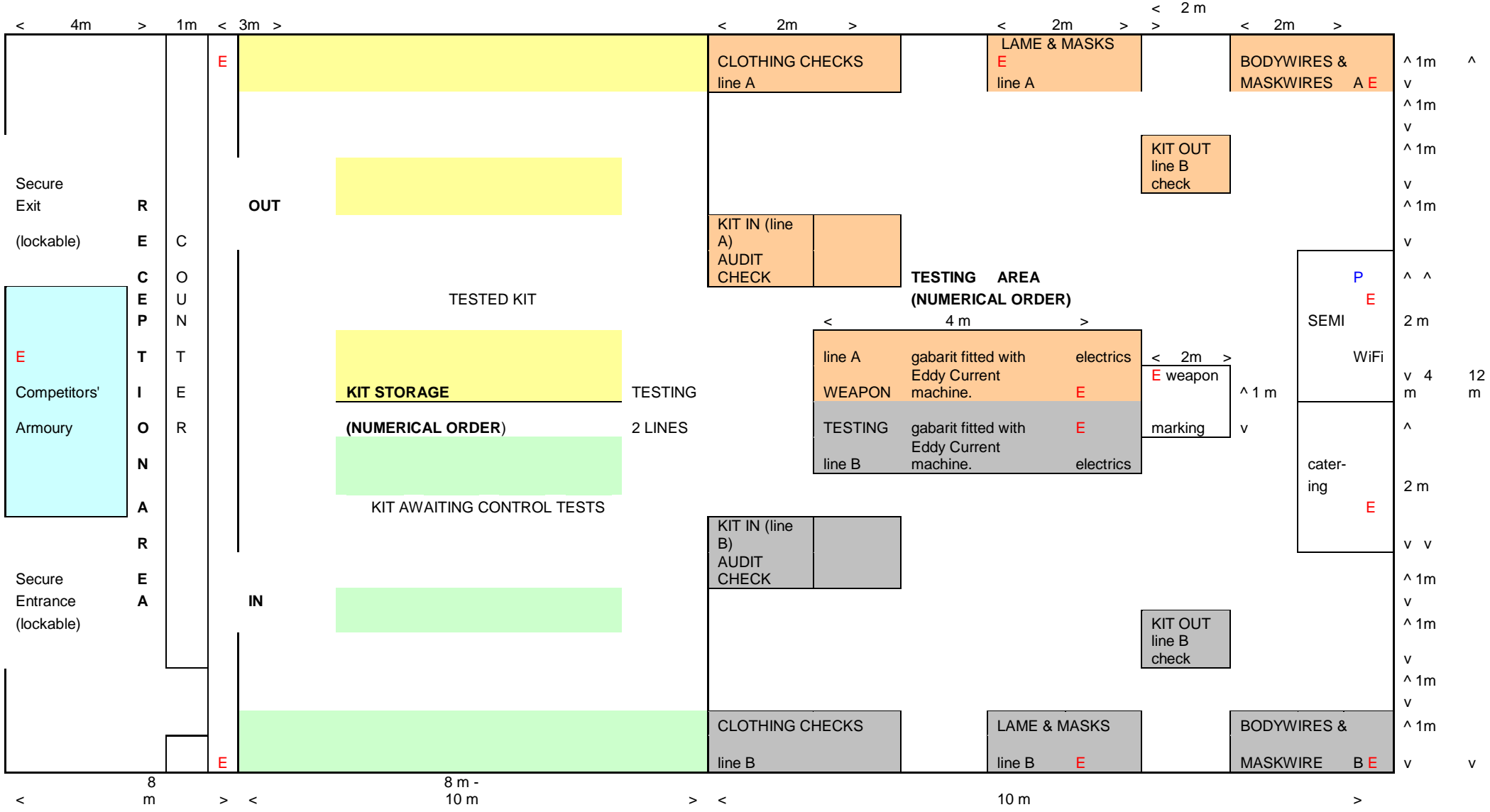

The entire Weapon Control Area should be secured by lockable doors

E electrical supply needed **P** printer

Appendix 2

Weapon Control Submissions and Returns Example Protocol

An example of a protocol is detailed below:-

“

1. Competitors can only submit kit during the published hours and will only be allowed to collect kit during the published collection times.
2. Competitors submit competition kit in a fencing bag (There should be no other equipment in the bag)
3. The contents will be checked at the Counter and a RECEIPT issued
4. The bag will then be placed in numerical order of receipt in the 'IN' Area
5. There will be two testing lines in order that two bags can be tested at one time
6. The bag will be taken from the in-store to the KIT IN table.
7. The contents will be checked against a copy of the receipt and then distributed around the tables of the appropriate line
8. Clothing Checks will include checks for safety, legality and team conformity. Conforming clothing will be stamp marked. Non-conforming clothing will have any FIE label stamp marked "X"
9. Clothing checks will be made on plastrons, breeches, jackets, gloves, socks and epee masks
10. Weapon checks will include the full range of gabarit checks, electrical and conformity checks. The points of foils and epees will not be tested for weight and gauge conformity.
11. Conforming weapons will have the blades etched and the guards marked with a non-removable label.
12. Foil and Sabre Conductive Jackets, Foil and Sabre Masks, Sabre Gloves and Overlays will be checked for electrical continuity.
13. Conforming kit will be stamp marked.
14. Foil and Sabre masks and sabre gloves will be safety checked
15. Body wires and Mask wires will be checked for legality and electrical conformity. Conforming wires will be marked with a security cable tie.
16. Once the tests are complete an inspectors' report on non-conforming items will be completed and all the kit will be returned to the bag in which it was submitted
17. The finished bag will then be placed in the 'OUT' area to await collection by the submitter
18. When the bag is returned the submitter will need to provide their copy of the receipt. A Weapon Control receptionist will talk through any problems/failures.
19. Emergency submissions will be taken at any time that the Weapon Control is open and will 'queue jump'.”

The protocol should be relevant to the tournament in question.

Appendix 3a

Competition

SUBMISSION

Pays/Country:.....

NOMBRE/NUMBER:.....

Remis Par/Left by:.....

Date:.....

L'Article/Item	Depose	Retire	Non conforme	Remarques/Comments
	In	Out	Failed	
Fleuret/Foil				
Epee				
Sabre				
Masque/mask Foil				
Masque/mask Sabre				
Masque/mask Epee				
Plastron Metallique/ Metallic Jacket Foil				
Veste Metallique/ Metallic Jacket Sabre				
Sabre Gant/ Sabre Glove				
Sabre Manchette/Overlay				
Gant/Glove				
Veste/Jacket				
Pantalon/breeches				
Plastron protecteur/plastron				
Chaussettes/Socks				

RETURN

Recu par/Received by:.....

Date:.....

Signed:.....

Appendix 3b
Parcel labels for marking bags

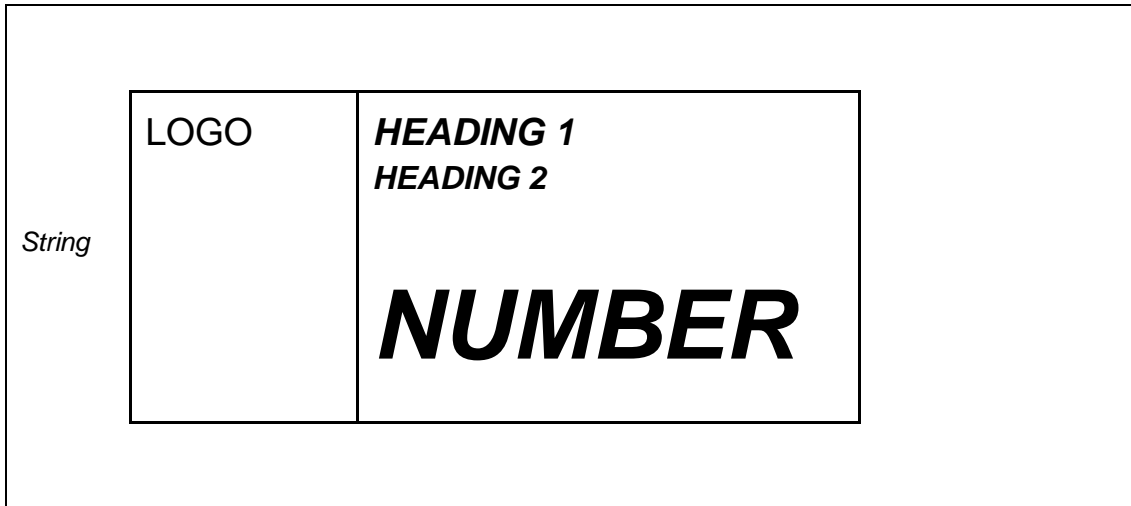

Appendix 3d
Parcel labels for marking failed equipment

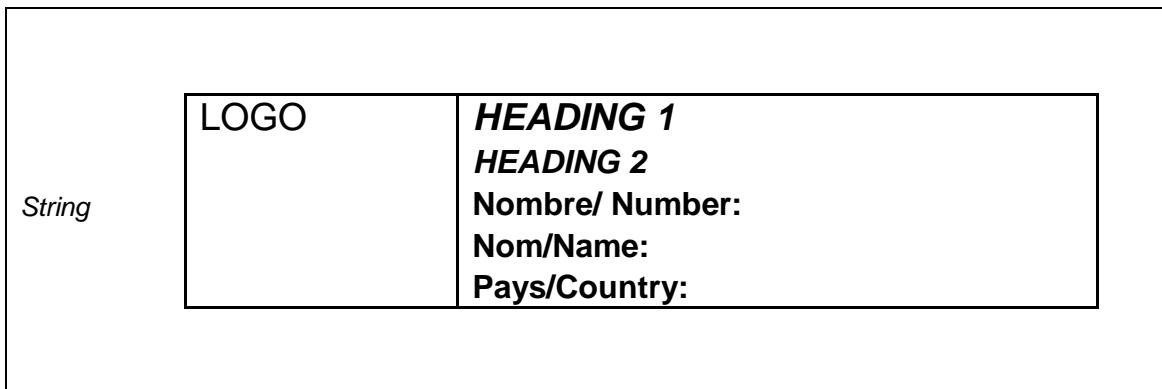

Appendix 3c
Inspectors report page 1

LOGO

HEADING 1
HEADING 2

1

L'epreuve/Test	Remarques/Remarks	Paraphe
1. Marque d'approbation sur la lame FIE mark on blade		
2. Poids d'armes Weight of Weapon		
3. Diametre de la coquille Diameter of the guard		
4. Exentricitie de la coquille Shape of the guard		
5. Profondeur de la coquille Depth of the guard		
6. Longueur de la lame Length of the blade		
7. Longueur de la poignee Length of the handle		
8. Longueur de l'arme Length of the weapon		
9. Flexibilite de la lame Flexibilty of the blade		
10. Fleche de la lame Curve on the blade		
11. Dimensions de la lame et pointe Dimensions of the blade and point		
12. Oxyde de la coquille ou la lame Oxidation on the guard or blade		
13. Poids repousse de la pointe Strength of tip spring		
14. Course totale de la pointe Total travel of the point		
15. Course residuelle de la pointe Residual travel of the point		
16. Isolation electrique de la lame Insulation on the blade		
17. Isolation electrique de la prise et fil. Insulation of the socket and wire		
18. Resistance ohmique Electrical resistance		
19 Courants de Foulcault Eddy Current tests		



HEADING 1
HEADING 2

Controle Des Armes/Weapon Control

Inspecteur/ Weapon Contoller:.....

Non-Conformity Report:

Date:.....

Relates to Submission Sheet No.:

L'epreuve/Test	Remarques/Remarks	Paraphe
19. Masque: marque d'approbation Mask: FIE mark		
20. Masque: condition et isolation Mask: condition and insulation		
21. Masque: Sabre/Foil: Resistance Sabre/Foil mask electrical resistance		
22. La veste metallique: condition Metallic jacket condition		
23. La veste metallique: resistance Metallic jacket electrical resistance		
24. Sabre gant/manchette condition Sabre glove/overlay condition		
25. Sabre gant/manchette resistance Sabre glove/overlay electrical resistance		
26. Gant Glove		
27. Veste Jacket		
28. Pantalon Breeches		
29. Plastron protecteur Plastron		
30. Chaussettes Socks		
31. Des autres articles other items		

Appendix 4
SEMI COMMISSION COMPETITION REPORT

EVENT World Championships
 Venue City
 Dates Start Finish
 SEMI Commission Members

Semen RIKTMAN RUS
 Janet HUGGINS GBR
 Gudjon Ingi GESTSSON ISL

Venue
 1 Final hall

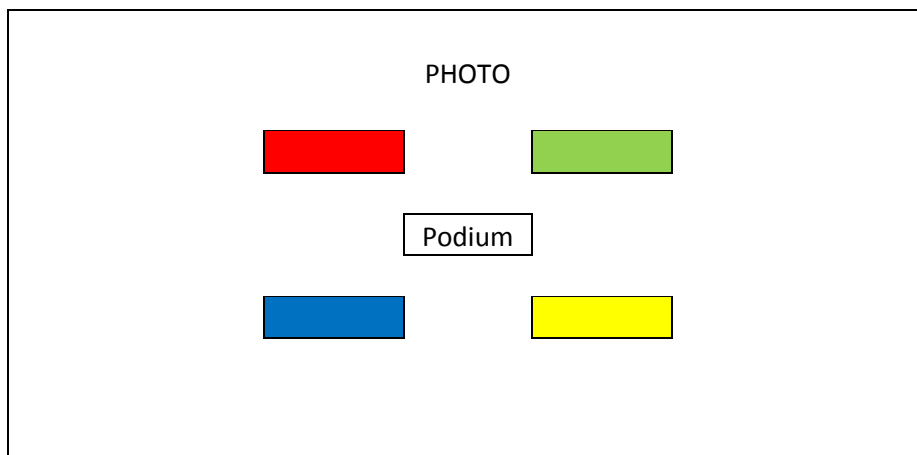

Plate Pistes	Manufacturer	Piste number
	Greenapple	FIE E2008 001/5
Total		5
Scoring boxes	Make	Allstar
	Model	
Reels	Make	
Video referring	Make	
Wireless	Make	

2 Preliminary Hall

PHOTO		

Plate Pistes

Manufacturer
Greenapple

Piste number
FIE E2008 006/10

Total

5

Carpet Pistes

Manufacturer
Allstar
Artois
Leon Paul

Number
5
6
2

Total

13

WEAPON
3 CONTROL

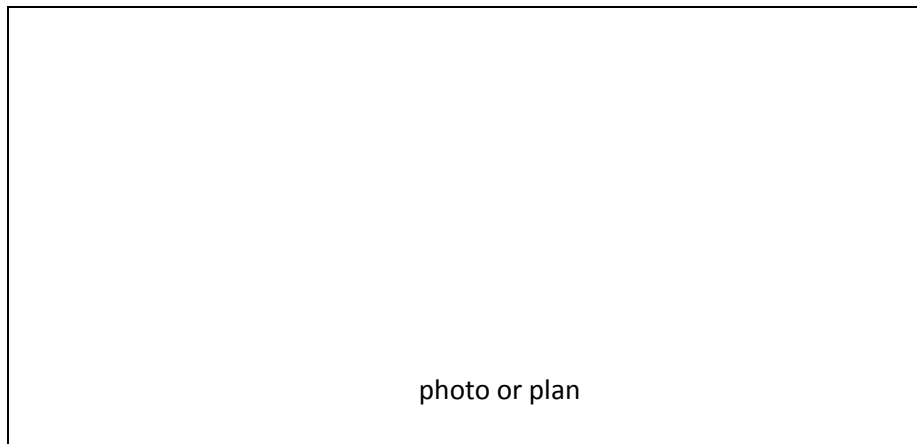

a Test & marking equipment

	Make	Number
Gabarit		2
Flexibility tester		2
Eddy Current		2
Test machines/Multimeters		6
Blade marking Etching/engraving		2
Tags & Labels for body wires		yes/no
Stamp for clothing		yes/no

b Fencing equipment submitted for testing

Weapons	Dimensions	yes/no
	FIE Homologation	yes/no
	Electrical resistance	yes/no
	Insulation of wires	yes/no
	Flexibility	yes/no
	Eddy current	yes/no
	Conforms to rules	yes/no
Body/Mask wires	Electrical resistance	yes/no
	Soldered joints	yes/no
	Conforms to rules	yes/no
Mask	FIE Homologation	yes/no
	Electrical resistance	yes/no
	Condition & safety	yes/no
	Conforms to rules	yes/no

Clothing	Jackets - Breeches - Plastrons	yes/no
	FIE Homologation	yes/no
	Condition & safety	yes/no
	Name & Country	yes/no
	Country Logo	yes/no
	Publicity	yes/no
	Conforms to rules	yes/no

Metallic Jackets - gloves - sabre gloves - sabre overlays	
FIE Homologation - sabre gloves	yes/no
Condition & safety	yes/no
Electrical resistance	yes/no
Name & Country	yes/no
Conforms to rules	yes/no

c	Weapon Control System	
	Sequential numbering of bags	yes/no
	Items of equipment counted & checked on submission sheet (original retained with bag copy to person submitting bag)	yes/no
	Bags checked in sequential order	yes/no
	Failed items noted on failure sheet (original retained by weapon control copy to person reclaiming bag)	yes/no
	Passed items marked with control mark	yes/no
	Bags collected upon presentation of copy submission sheet (Items counted and failures explained)	yes/no
	Submission and failure sheets used to compile statistics	yes/no

4	CALL ROOM	
	Make	
	Wireless system	yes/no
	Individual Competitions - Pre-fight checks	
	Check made for control marks on clothing including plastrons	yes/no
	Check made for control marks on weapons body/mask wires, masks, metallic jackets and gloves	yes/no
	Weapons and body/mask wires checked for resistance	yes/no
	Weapons checked for weight and gauge when appropriate	yes/no

Team Competitions - Pre fight checks

Check made for control marks on clothing including plastrons

yes/no

Check made for control marks on weapons body/mask wires,
masks, metallic jackets and gloves

yes/no

Weapons and body/mask wires checked for resistance

yes/no

Weapons checked for weight and gauge when appropriate

yes/no

Checks made on matching country logos and uniforms

yes/no

COMMENTS

--

World Cadet/Junior Summary Weapon Control - Event Date 2013

Country	Sabre		Epee		Foil		Fil de Corps		Fil de Masque		Masque		Lame Jacket		Glove		Jacket		Breeches		Plastron		TOTAL ITEMS	
	Pass	Fail	Pass	Fail	Pass	Fail	Pass	Fail	Pass	Fail	Pass	Fail	Pass	Fail	Pass	Fail	Pass	Fail	Pass	Fail	Pass	Fail	Pass	Fail
Cadet W Sabre	141	37					177	20	160	9	71	3	80	7	105	7	71	1	67	3	70	1	942	157
Cadet M Sabre	170	62					189	29	173	18	78	7	93	14	137	12	83	4	81	10	85	0	1089	156
Cadet M & W Epee			543	185			537	57			172	37			232	42	201	9	205	10	206	1	2096	341
Cadet M Foil					271	84	254	38	205	26	96	12	137	20	112	18	102	0	95	1	104	0	1376	199
Cadet W Foil					225	50	215	16	177	11	67	17	108	14	91	12	75	6	76	7	94	4	1128	137
Junior M & W Epee			623	103			527	78			186	17			229	35	195	20	201	5	208	1	2169	259
Junior M Foil					247	51	218	28	164	12	79	14	111	12	91	19	82	3	77	2	87	0	1156	141
Junior M Sabre	211	37					230	35	196	19	94	1	112	7	142	19	94	1	87	5	95	1	1261	125
Junior W Foil					193	31	174	10	119	19	58	11	97	11	83	9	69	1	65	5	72	1	930	98
Junior W Sabre	126	24					138	32	131	9	58	4	64	4	99	7	59	0	53	5	59	0	787	85
Totals	648	160	1166	288	936	216	2659	343	1325	123	959	123	802	89	1321	180	1031	45	1007	53	1080	9	12934	1698
GRAND TOTAL		808		1454		1152		3002		1448		1082		891		1501		1076		1060		1089		14632
FAILURES		20%		20%		19%		11%		8%		11%		10%		12%		4%		5%		1%		12%

SEMI Commission Competition Report

EVENT Cadet/Junior World Championships

Venue City Tashkent

Dates April 2015 Start 01 Finish 09

SEMI Commission Members

Sarkis ASSADOURIAN	IRI
Tarek BEN RAJAB	TUN
Daniel DE CHAINE	USA

Venue

- Final hall

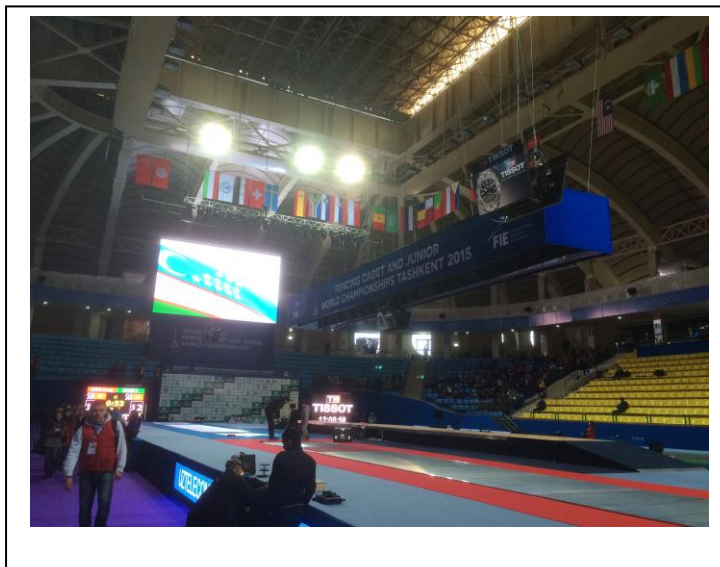

Plate Pistes

Manufacturer

Pistes

Allstar

FIE
01/5

Total

5

Scoring boxes

Make

Allstar

SEMI Commission Competition Report

	Model	<input type="text"/>
Reels	Make	<input type="text" value="Allstar"/>
Video referring	Make	<input type="text" value="Tissot"/>
Wireless	Make	<input type="text" value="No"/>

Preliminary

2 Hall

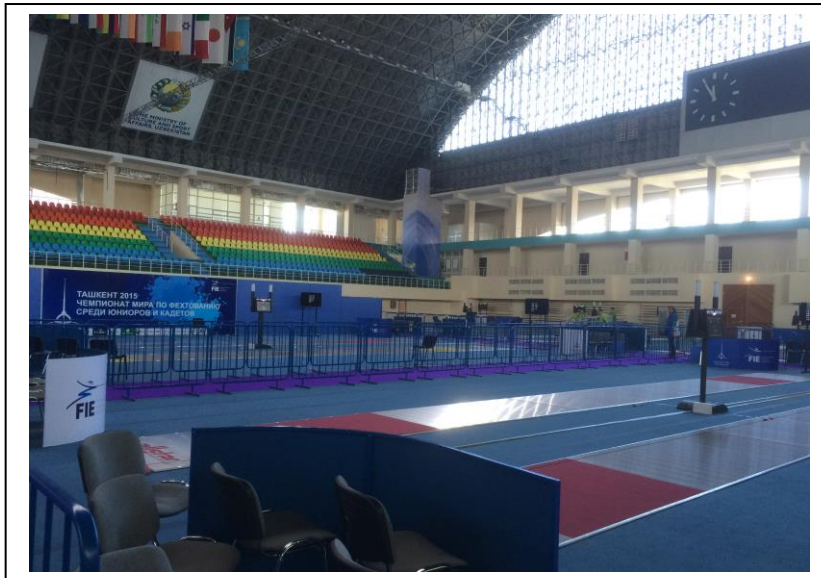

Plate Pistes

Manufacturer

Piste number

Allstar

Total

Carpet Pistes

Manufacturer

Allstar

Artois

Leon Paul

Number

<input type="text" value="0"/>
<input type="text"/>
<input type="text"/>
<input type="text"/>

Total

SEMI Commission Competition Report

WEAPON

3 CONTROL

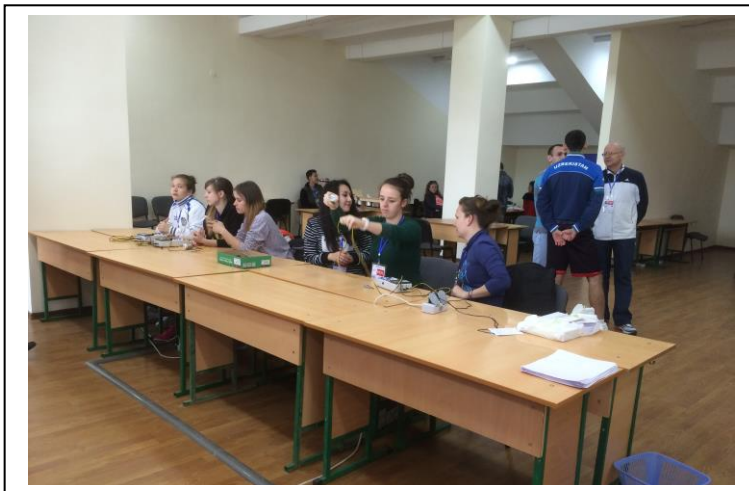

a Test & marking equipment

Gabarit
 Flexibility tester
 Eddy Current
 Test machines/Multimeters
 Blade marking Etching/engraving
 Tags & Labels for body wires
 Stamp for clothing

Make

Number

	2
	2
	2
	8
	0
	yes
	yes

b Fencing equipment submitted for testing

SEMI Commission Competition Report

Weapons

Dimensions
 FIE Homologation
 Electrical resistance
 Insulation of wires
 Flexibility
 Eddy current
 Conforms to rules

Body/Mask wires

Electrical resistance
 Soldered joints
 Conforms to rules

Mask

FIE Homologation
 Electrical resistance
 Condition & safety
 Conforms to rules

Clothing

FIE Homologation
 Condition & safety
 Name & Country
 Country Logo
 Publicity
 Conforms to rules

Jackets - Breeches - Plastrons

Yes
Yes
Yes
Yes
Yes
yes

Metallic Jackets - gloves - sabre gloves - sabre overlays

FIE Homologation - sabre gloves

Condition & safety

Electrical resistance

Name & Country

Conforms to rules

yes
yes
yes
Yes
yes

c Weapon Control System

Sequential numbering of bags

yes

Items of equipment counted & checked on submission sheet
 (original retained with bag copy to person submitting bag)

yes

Bags checked in sequential order

yes

Failed items noted on failure sheet

yes

(original retained by weapon control copy to person reclaiming bag)

Passed items marked with control mark

yes

Bags collected upon presentation of copy submission sheet

yes

SEMI Commission Competition Report

(Items counted and failures explained)

Submission and failure sheets used to compile statistics



4 CALL ROOM

Wireless system Make

Individual Competitions - Pre-fight checks

Check made for control marks on clothing including plastrons

Check made for control marks on weapons body/mask wires, masks, metallic jackets and gloves

Weapons and body/mask wires checked for resistance

Weapons checked for weight and gauge when appropriate

Team Competitions - Pre fight checks

Check made for control marks on clothing including plastrons

Check made for control marks on weapons body/mask wires, masks, metallic jackets and gloves

Weapons and body/mask wires checked for resistance

Weapons checked for weight and gauge when appropriate

Checks made on matching country logos and uniforms

SEMI Commission Competition Report

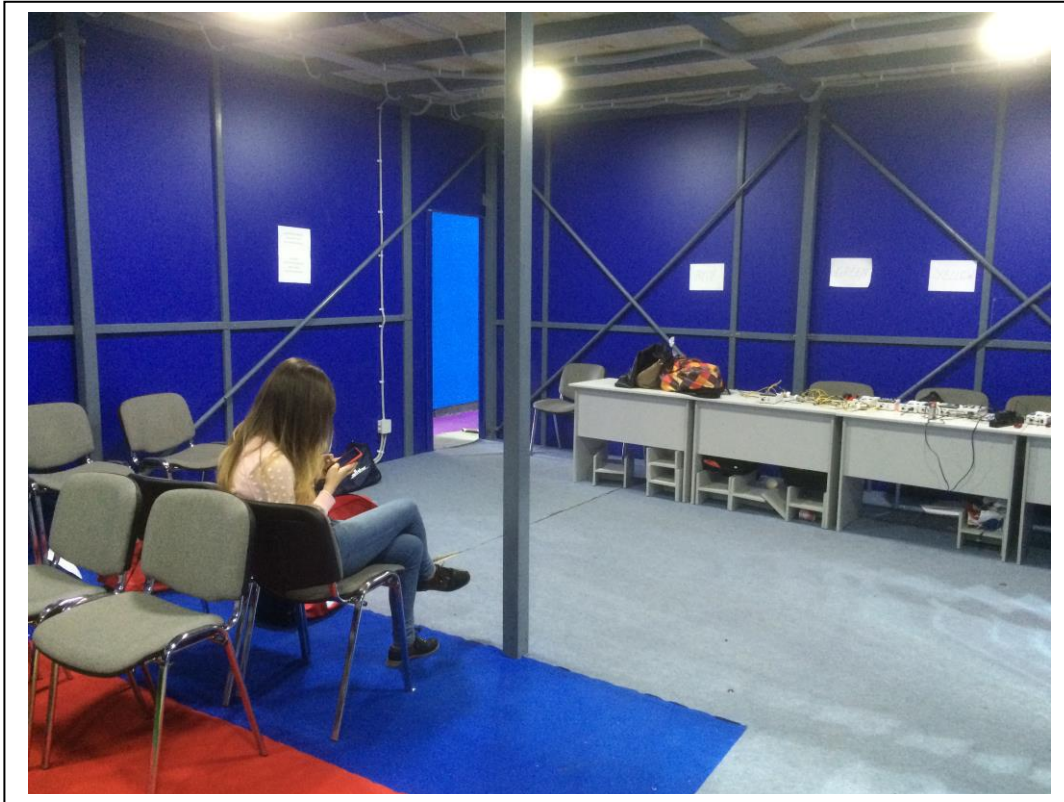

Comments:

1- The Championships was very well organised and there was only two small matters: a- Lack of equipment stores (because of custom rules) b- Lack of printing facility on the clothes. The first matter luckily solved by support of Int. Charity Fund that is very commendable. For the second matter in the first day of weapon control the SEMI Delegate wrote a letter to DT regarding absence of the names and logos on the some clothes and ask them for necessary decision. DT decided that mentioned fencers can fence only in the first round not in DE.

2- Many plastrons made by Cartel, Leon Paul, Allstar, Carmimari and etc.....were very short in the neck part and didn't protect the neck and also vital parts, so they were not confirmed to rules. New certification is necessary for plastrons.

SEMI Commission Competition Report

3- There was problems with the Leon Paul 2015 V blades when they checked by Eddy current (the points are marked by white tapes in attached photos).

4- Checking and control the Foil Masks with replaceable bibs were not possible, because the stamp was on the bib and the fencers could replace them by rejected masks. So using the masks with replaceable bibs must be stop till the manufacturer resolve this problem and get new certification.

5- The Call Room was a little small, so checking the fencers was with difficulty. In future competitions the call room must be confirmed to rules.

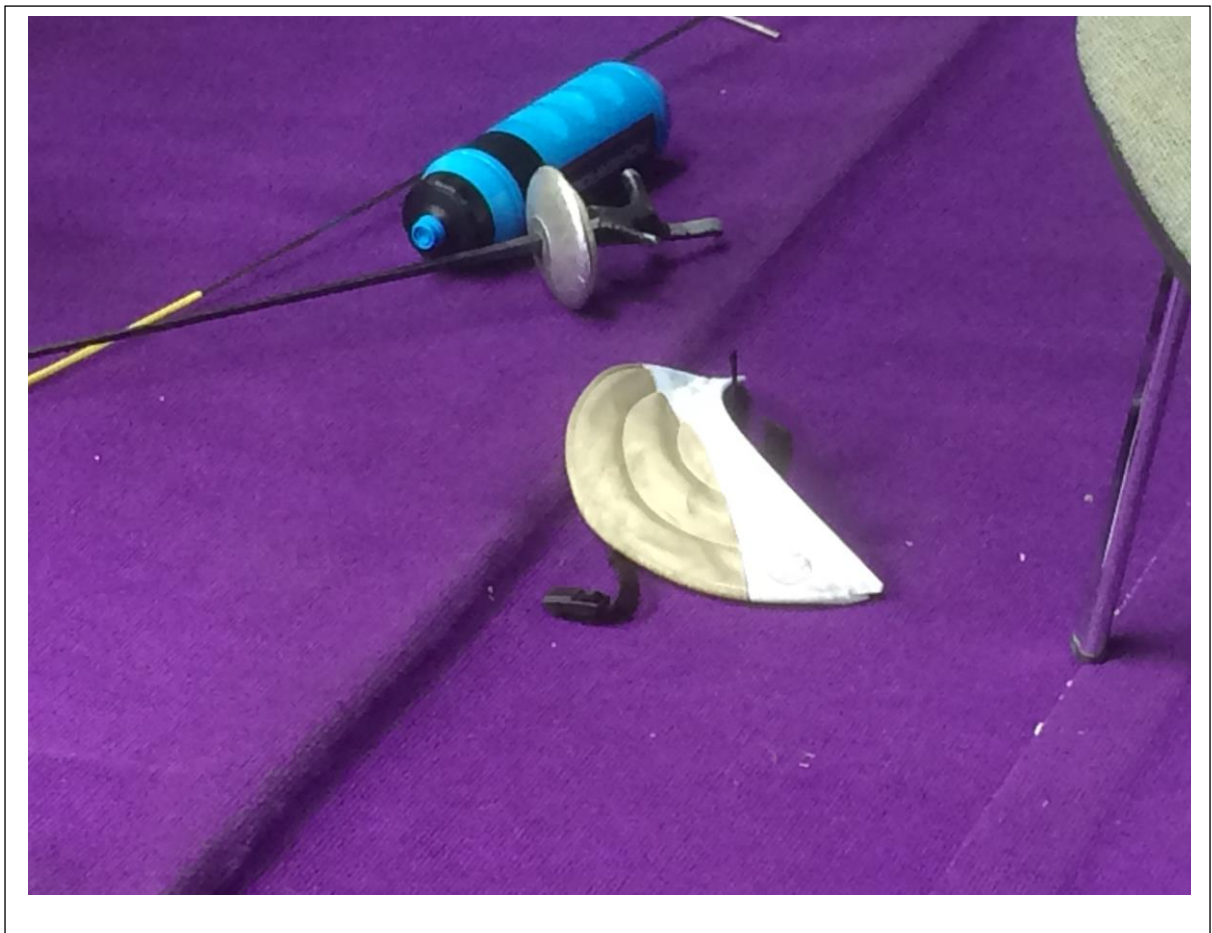

SEMI Commission Competition Report



SEMI Commission Competition Report



SEMI Commission Competition Report

Equipment control statistics:

(at 06.04.2015 14:21:52)

- Total number of fencers: **1108**.
- Total number of teams: **85**.
- Total number of tickets: **634**.
- Total number of checked equipment: **15394**.
- Total number of Accepted equipment: **14694**.
- Total number of Rejected equipment: **700**.
- Rejected Percentage: **4,5%**.

Foil

- Total number of fencers: **351 (mens - 203, womens - 148)** .
- Total number of teams: **56**.
- Total number of tickets: **198**.
- Total number of checked equipment: **5704**.
- Total number of Accepted equipment: **5479**.
- Total number of Rejected equipment: **225**.

Rejected Percentage: **3,9%**.

SEMI Commission Competition Report

№	Name equipment	Men			Women			SUM		
		Checked	Rejected	%	Checked	Rejected	%	Checked	Rejected	%
1	Weapon	709	12	1,7	517	14	2,7	1226	26	2,1
2	Body wire	645	65	10	486	44	9,1	1131	109	9,6
3	Mask wire	511	20	3,9	371	16	4,3	882	36	4,1
4	Cond. Jacket	312	15	4,8	221	10	4,5	533	25	4,7
5	Mask	204	6	2,9	153	9	5,9	357	15	4,2
6	Jacket	207	2	0,9 7	143	2	1,4	350	4	1,1
7	Under-plastron	210	0	0	161	0	0	371	0	0
8	Breeches	203	5	2,5	142	0	0	345	5	1,4
9	Glove	291	1	0,3 4	218	4	1,8	509	5	0,98
10	Total	3292	126	3,8	2412	99	4,1	5704	225	3,9

SEMI Commission Competition Report

Sabre

- Total number of fencers: **296 (mens - 172, womens - 124)** .
- Total number of teams: **46**.
- Total number of tickets: **173**.
- Total number of checked equipment: **4289**.
- Total number of Accepted equipment: **4098**.
- Total number of Rejected equipment: **191**.

Rejected Percentage: **4,5%**.

№	Name equipment	Men			Women			SUM		
		Checked	Rejected	%	Checked	Rejected	%	Checked	Rejected	%
1	Weapon	435	21	4,8	337	12	3,6	772	33	4,3
2	Body wire	506	61	12	382	40	10	888	101	11
3	Mask wire	415	14	3,4	349	16	4,6	764	30	3,9
4	Cond. Jacket	203	9	4,4	149	8	5,4	352	17	4,8
5	Mask	173	3	1,7	124	3	2,4	297	6	2
6	Jacket	164	0	0	122	0	0	286	0	0

SEMI Commission Competition Report

7	Under-plastron	163	0	0	127	0	0	290	0	0
8	Breeches	162	1	0,6 2	117	1	0,85	279	2	0,72
9	Glove	200	2	1	161	0	0	361	2	0,55
10	Total	2421	111	4,6	1868	80	4,3	4289	191	4,5

Epee

- Total number of fencers: **461 (mens - 267, womens - 194)** .
- Total number of teams: **76**.
- Total number of tickets: **263**.
- Total number of checked equipment: **5401**.
- Total number of Accepted equipment: **5117**.
- Total number of Rejected equipment: **284**.

Rejected Percentage: **5,3%**.

№	Name equipment	Men			Women			SUM		
		Checked	Rejected	%	Checked	Rejected	%	Checked	Rejected	%
1	Weapon	880	50	5,7	620	26	4,2	1500	76	5,1
2	Body wire	822	108	13	624	40	6,4	1446	148	10
3	Mask wire	0	0	0	3	0	0	3	0	0
4	Cond. Jacket	0	1	0	0	0	0	0	1	0

SEMI Commission Competition Report

5	Mask	260	5	1,9	192	0	0	452	5	1,1
6	Jacket	269	14	5,2	195	6	3,1	464	20	4,3
7	Under-plastron	276	4	1,4	191	1	0,52	467	5	1,1
8	Breeches	261	9	3,4	193	8	4,1	454	17	3,7
9	Glove	369	8	2,2	246	4	1,6	615	12	2
10	Total	3137	199	6,3	2264	85	3,8	5401	284	5,3

SEMI Commission Competition Report

EVENT Universiade

CITY Gwangju

VENUE Kimdaejung Convention Center

Dates Start 04.07.2015 Finish 09.07.2015

SEMI Commission Delegates

Guðjón Ingi Gestsson Iceland

Local staff

Senior Technicians 15

Volunteers 35

Translators

SEMI Commission Competition Report

Venue

1

FINALS HALL

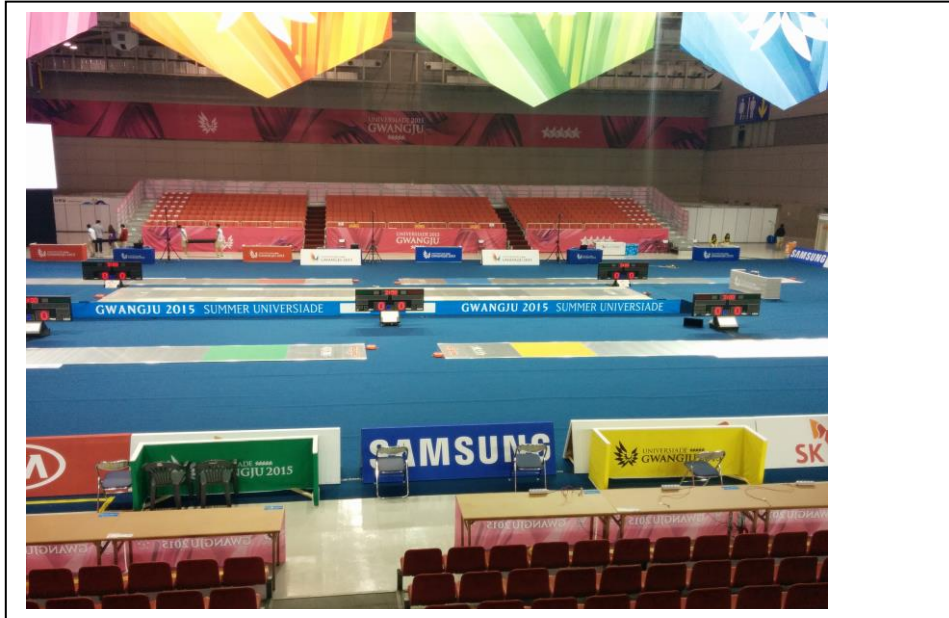

Podium and 4 coloured Plate pistes

Manufacturer

Allstar

Scoring Boxes

Manufacturer

Allstar

Model

Reels

Allstar

Video Refereeing

Kabcom

Wireless

none

SEMI Commission Competition Report

Venue

2 Preliminary Hall



Plate pistes

Manufacturer / no

12

Scoring Boxes

Manufacturer

Allstar

Model

Reels

Allstar

Video Refereeing

none

Wireless

none

SEMI Commission Competition Report

3 WEAPON CONTROL



Manual submissions

Testing Equipment

Gabarit	<input type="text" value="2"/>
Flexibility tester	<input type="text" value="2"/>
Eddy current	<input type="text" value="0"/>
Test machines/Multimeteres	<input type="text" value="8"/>
Blade marking /engraving	<input type="text" value="2"/>
Tags for body/mask wires	<input type="text" value="Yes"/>
Stamp for clothing	<input type="text" value="Yes"/>

SEMI Commission Competition Report

Fencing equipment submitted for testing

Weapons

Dimensions	Yes
Homologation	Yes
Electrical resistance	Yes
Insulation of wires	Yes
Flexibility	Yes
Eddy Current	No
Conforms to rules	Yes

Body/mask wires

Electrical resistance	Yes
Soldered joints	Yes
Conforms to rules	Yes

Mask

FIE Homologation	Yes
Electrical resistance	Yes
Condition and safety	Yes
Conforms to rules	Yes

Clothing

Jackets – Breeches – Plastron	
FIE Homologation	Yes
Condition and safety	Yes
Name and Country	Yes
National Logo	Yes
Publicity	
Conforms to rules	Yes

Metallic jackets – gloves- sabre gloves/overlays	
FIE Homologation (Sabre gloves)	Yes
Condition and safety	Yes
Electrical resistance	Yes
Name and Country	Yes
Conforms to rules	Yes

SEMI Commission Competition Report

WEAPON CONTROL SYSTEM

- Sequential numbering of bags
- Items of equipment counted on submission sheet
- Bags checked in sequential order
- Failed items noted
- Passed items marked with control mark
- Bags collected on presentation of sheet failures explained
- Statistics compiled

Yes
Yes
Yes
Yes
Yes
Yes
Yes

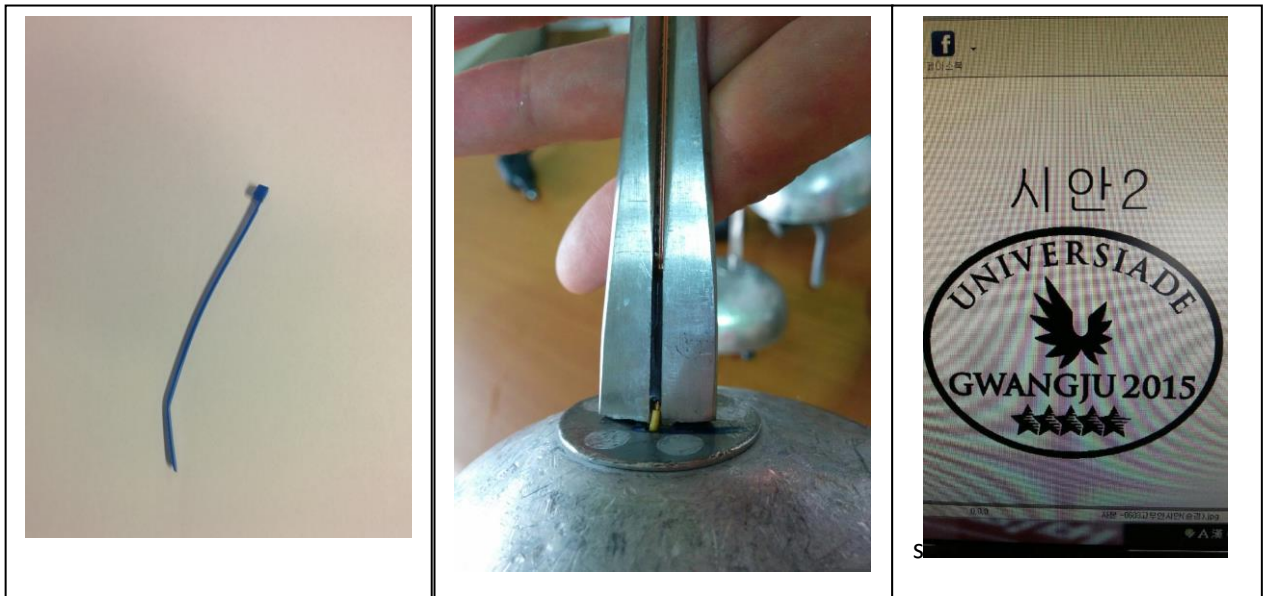

SEMI Commission Competition Report

5 CALL ROOM

--	--

Wireless system - STM

Individual Competition Pre-fight checks

Check made for control marks on clothing including plastrons	Yes
Check made for control marks on weapons body/mask wires, masks, metallic jackets and gloves	Yes
Weapons and body/mask wires checked for resistance	Yes
Weapons checked for weight and gauge when appropriate	Yes

Team Competitions - Pre fight checks

Check made for control marks on clothing including plastrons	Yes
Check made for control marks on weapons body/mask wires, masks, metallic jackets and gloves	Yes
Weapons and body/mask wires checked for resistance	Yes
Weapons checked for weight and gauge when appropriate	Yes
Checks made on matching country logos and uniforms	No

SEMI Commission Competition Report

Weapon Control was very effective. There were two doors, enter and exit. At the enter-door, there was one volunteer writing down the items accepted, and several volunteers taking the items, putting in a bag and following that bag through a line of technicians testing the different types of items (mask, whites, vires, lame, and weapons), all the way to the exit door, where the items were returned to the fencer with explanations. I took the time on one bag, from the time it had been filled up in entry, until it was ready to be returned at exit, and it was 1.5 minutes.

The call room was also well equipped (and well positioned under the DT). Only thing I would have liked to improve, was that the bags where not behind a barrier, so the fencers had access to them while waiting.

SEMI Commission Competition Report

Woman Sabre

#	Country	Weapon		Body cord		Mask		Mask cord		Lame		Glove		Under plastron		Uniform	
		Pass	Fail	Pass	Fail	Pass	Fail	Pass	Fail	Pass	Fail	Pass	Fail	Pass	Fail		
2	AUSTRALIA	5	0	6	0	2	0	6	0	2	0	2	0	2	0	2	0
3	AZERBAIJAN	6	0	8	0	3	0	8	1	5	0	3	0	1	0	2	0
3	CHINA	6	0	9	0	2	0	6	2	3	0	2	0	1	0	1	0
4	FRANCE	12	0	9	2	4	0	10	1	6	0	6	0	4	0	4	0
3	HONG KONG	0	0	3	1	1	0	3	0	2	0	2	0	1	0	1	0
3	HUNGARY	10	0	14	1	3	0	10	2	3	0	5	0	2	0	3	0
4	ITALY	12	0	9	1	4	9	6	2	5	0	5	0	4	0	4	0
3	JAPAN	7	0	4	1	3	0	1	3	3	0	3	0	3	0	3	0
4	KAZAKHSTAN	9	0	15	1	5	0	7	1	4	1	7	0	5	0	5	0
4	KOREA	9	0	9	0	4	0	9	0	6	0	5	0	4	0	4	0
4	POLAND	8	0	11	1	4	0	10	3	5	1	5	0	4	0	4	0
4	RUSSIA	11	0	8	0	4	0	7	1	4	0	3	0	4	0	4	0
2	SINGAPORE	6	0	6	1	2	0	5	0	2	0	2	0	2	0	2	0
4	UKRAINE	4	0	7	1	4	0	5	1	4	0	3	1	4	0	4	0
4	USA	11	0	8	1	3	1	8	0	4	0	6	0	4	0	4	0
4	VENEZUELA	11	0	11	1	4	0	8	1	6	0	6	0	5	0	6	0
Totals		127	0	137	12	52	10	109	18	64	2	65	1	50	0	53	0
Grand totals			127		149		62		127		66		66		50		53
Percentage reject			0%		8%		16%		14%		3%		2%		0%		0%

SEMI Commission Competition Report

Woman Foil

#	Country	Weapon		Body cord		Mask		Mask cord		Lame		Glove		Under plastron		Uniform	
		Pass	Fail	Pass	Fail	Pass	Fail	Pass	Fail	Pass	Fail	Pass	Fail	Pass	Fail	Pass	Fail
1	ARGENTINA	5	0	3	0	0	1	2	0	1	0	1	0	1	0	1	0
1	AUSTRIA	4	0	4	0	1	0	4	0	2	0	2	0	1	0	1	0
1	BRAZIL	3	1	3	0	1	0	2	0	2	0	2	0	1	0	1	0
1	CANADA	5	0	3	0	1	0	3	0	2	0	2	0	1	0	1	0
4	CHINA	6	2	3	0	2	1	7	0	4	0	3	0	1	0	1	0
4	FRANCE	18	0	13	0	4	0	10	0	7	0	5	0	4	0	3	0
3	HONG KONG	9	0	10	1	3	0	6	0	5	1	5	0	3	0	3	0
2	HUNGARY	9	0	9	0	2	1	8	0	4	0	3	0	2	0	2	0
4	ITALY	10	2	15	1	3	1	7	2	9	1	5	0	4	0	3	0
3	JAPAN	10	1	11	0	2	0	10	1	5	1	5	0	5	0	3	0
4	KOREA	12	1	10	0	4	0	7	1	6	0	6	0	4	0	4	0
1	MALAYSIA	3	0	5	0	2	0	3	0	2	0	1	0	1	0	1	0
2	NEW ZEALAND	8	2	10	1	2	0	9	0	2	1	3	0	1	0	2	0
3	POLAND	10	1	12	0	3	0	6	0	4	1	3	0	1	0	1	0
4	RUSSIA	15	1	13	1	3	1	7	0	6	2	5	0	4	0	4	0
1	SLOVAKIAN REPUBLIC	3	1	6	0	1	0	5	0	2	0	2	0	1	0	1	0
1	TURKEY	4	0	4	0	1	0	3	0	2	0	1	0	1	0	1	0
4	USA	22	0	15	0	4	0	7	0	7	0	5	0	4	0	4	0
2	VENEZUELA	5	1	3	0	1	0	2	0	3	0	2	0	3	0	1	0
Totals		152	13	145	4	39	4	102	4	72	7	58	0	41	0	36	0
Grand totals			165		149		43		106		79		58		41		36
Percentage reject			8%		3%		9%		4%		9%		0%		0%		0%

SEMI Commission Competition Report

Women Epee

#	Country	Weapon		Body cord		Mask		Mask cord		Lame		Glove		Under plastron		Uniform	
		Pass	Fail	Pass	Fail	Pass	Fail	Pass	Fail	Pass	Fail	Pass	Fail	Pass	Fail	Pass	Fail
1	ARMENIA	2	0	5	0	1	0	0	0	0	0	2	0	1	0	1	0
1	AUSTRALIA	3	0	2	0	2	0	0	0	0	0	1	0	0	0	0	0
1	AUSTRIA	4	0	4	0	1	0	0	0	0	0	1	0	1	0	1	0
1	BRAZIL	3	1	4	1	1	0	0	0	0	0	1	0	1	0	1	0
1	CANADA	2	1	4	0	1	0	0	0	0	0	1	0	1	0	1	0
3	CHINA	8	1	9	0	3	0	0	0	0	0	1	0	1	0	1	0
3	ESTONIA	9	1	8	0	1	0	0	0	0	0	1	0	1	0	1	0
4	FRANCE	14	1	13	2	4	0	0	0	0	0	4	0	4	0	4	0
3	HONG KONG	9	0	11	2	3	0	0	0	0	0	7	0	4	0	3	0
3	HUNGARY	13	0	10	0	3	0	0	0	0	0	7	0	3	0	3	0
3	ISRAEL	9	0	9	0	3	0	0	0	0	0	3	0	3	0	3	0
4	ITALY	16	0	17	0	4	0	0	0	0	0	5	0	4	0	4	0
3	JAPAN	7	4	11	1	3	0	0	0	0	0	4	0	3	0	3	0
4	KOREA	11	1	10	0	4	0	0	0	0	0	5	0	4	0	4	0
1	LEBANON	3	2	5	0	0	0	0	0	0	0	0	0	0	0	0	0
4	MONGOLIA	8	3	9	0	4	0	0	0	0	0	4	0	4	0	4	0
4	POLAND	15	0	17	0	5	0	0	0	0	0	5	0	1	0	1	0
1	PORTUGAL	4	0	3	0	1	0	0	0	0	0	1	0	1	0	1	0
4	RUSSIA	11	1	11	1	4	0	0	0	0	0	4	0	4	0	4	0
2	SINGAPORE	7	0	7	1	2	0	0	0	0	0	4	0	2	0	2	0
3	SWEDEN	7	3	10	0	4	0	0	0	0	0	4	0	3	0	3	0
3	CHINESE TAIPEI	9	0	8	0	3	0	0	0	0	0	3	0	3	0	3	0
4	UKRAINE	12	0	13	0	4	0	0	0	0	0	5	0	4	0	4	0
4	USA	16	1	13	0	4	1	0	0	0	0	5	0	4	0	4	0
1	UZBEKISTAN	3	0	3	0	1	0	0	0	0	0	2	0	1	0	1	0
1	VENEZUELA	3	0	3	0	2	0	0	0	0	0	2	0	1	0	1	0

SEMI Commission Competition Report

Totals	132	15	140	3	45	1	0	0	0	0	53	0	39	0	39	0
Grand totals		147		143		46		0		0		53		39		39
Percentage reject		10%		2%		2%		0%		0%		0%		0%		0%

Men Sabre

#	Country	Weapon		Body cord		Mask		Mask cord		Lame		Glove		Under plastron		Uniform	
		Pass	Fail	Pass	Fail	Pass	Fail	Pass	Fail	Pass	Fail	Pass	Fail	Pass	Fail	Pass	Fail
3	AUSTRALIA	10	0	8	0	2	1	7	0	3	0	4	0	4	0	4	0
2	AUSTRIA	6	0	5	0	1	1	4	1	2	0	2	0	2	0	2	0
3	CANADA	6	1	10	1	3	0	10	0	2	0	3	0	3	0	4	0
3	CHINA	7	0	7	0	3	0	6	1	4	0	3	0	3	0	3	0
1	FIE	4	0	5	0	1	0	2	0	1	0	0	2	1	0	1	0
4	FRANCE	9	0	10	0	4	0	10	0	4	0	3	2	4	0	4	0
3	GERMANY	5	0	8	1	2	0	8	0	3	0	3	0	1	0	2	0
1	HONG KONG	3	0	3	0	2	1	3	0	2	0	1	1	1	0	1	0
4	HUNGARY	8	0	7	0	3	1	2	2	4	0	5	1	3	0	4	0
4	ITALY	9	0	9	0	4	0	4	0	6	0	4	0	4	0	4	0
4	JAPAN	6	0	8	2	2	0	7	0	2	1	2	0	2	0	2	0
4	KOREA	15	0	9		4	0	6	0	4	0	4	0	4	0	4	0
2	MALAYSIA	5	0	5	0	2	0	5	2	0	4	2	0	2	0	2	0
3	POLAND	7	0	8	0	3	0	8	0	4	0	4	0	3	0	3	0
4	RUSSIA	10	1	8	3	4	0	11	0	4	0	4	1	3	0	4	0
2	SWEDEN	4	0	4	0	2	0	4	0	2	0	2	0	2	0	2	0
4	UKRAINE	7	0	10	1	4	0	5	2	4	0	2	1	2	0	6	0
4	USA	8	0	11	1	4	1	10	0	4	0	4	0	4	0	4	0
2	VENEZUELA	6	0	6	0	2	0	4	0	2	0	1	0	2	0	2	0
	Totals	102	1	106	8	42	3	87	6	45	5	41	6	37	0	44	0
	Grand totals		103		114		45		93		50		47		37		44
	Percentage reject		1%		7%		7%		6%		10%		13%		0%		0%

SEMI Commission Competition Report

Men Foil

#	Country	Weapon		Body cord		Mask		Mask cord		Lame		Glove		Under plastron		Uniform	
		Pass	Fail	Pass	Fail	Pass	Fail	Pass	Fail	Pass	Fail	Pass	Fail	Pass	Fail	Pass	Fail
1	ARGENTINA	4	0	2	1	0	1	4	0	1	0	1	0	1	0	1	0
4	AUSTRALIA	15	0	15	0	4	0	8	1	9	0	8	0	5	0	6	0
1	BRAZIL	3	2	3	0	1	0	3	0	2	0	1	0	1	0	1	0
1	CANADA	4	0	2	0	1	0	2	0	1	0	1	0	1	0	1	0
4	CHINA	16	4	12	0	5	0	11	1	10	0	9	0	5	0	5	0
4	FRANCE	17	4	15	0	4	0	7	1	5	1	6	0	5	0	3	0
3	GREAT BRITAIN	11	1	10	0	2	1	8	0	6	0	6	0	3	0	3	0
2	HONG KONG	4	3	8	1	2	0	5	0	4	0	4	0	2	0	2	0
4	HUNGARY	19	0	18	1	4	0	14	0	7	0	5	0	4	0	4	0
3	INDONESIA	10	1	9	1	3	1	6	0	5	0	4	0	4	0	4	0
2	ISRAEL	5	0	9	0	2	0	6	1	1	1	3	0	2	0	2	0
4	ITALY	15	0	14	0	5	0	7	0	7	0	8	0	4	0	6	0
4	JAPAN	6	1	5	0	2	1	5	0	3	1	6	0	4	0	5	0
4	KOREA	14	0	12	0	4	0	4	0	4	0	5	0	4	0	4	0
2	MALAYSIA	7	0	12	0	1	0	5	1	2	0	2	0	3	0	2	0
1	NEPAL	2	1	4	0	2	0	1	0	2	0	3	0	2	0	2	0
1	NEW ZEALAND	2	1	4	0	1	0	3	0	1	1	1	0	1	0	1	0
4	POLAND	18	0	19	0	4	0	10	0	5	0	4	0	4	0	4	0
1	PORTUGAL	3	1	3	0	1	0	2	0	2	0	1	0	2	0	1	0
4	RUSSIA	8	0	5	0	2	0	2	0	3	1	2	0	2	0	2	0
1	SINGAPORE	3	0	4	0	0	1	2	0	1	1	1	0	1	0	1	0
2	TURKEY	9	0	9	0	2	0	5	0	4	0	4	0	4	0	2	0
4	USA	19	1	8	8	3	1	9	0	7	2	7	0	5	0	5	0
Totals		155	10	153	11	40	5	94	2	64	7	66	0	51	0	50	0
Grand totals			165		164		45		96		71		66		51		50
Percentage reject			6%		7%		11%		2%		10%		0%		0%		0%

SEMI Commission Competition Report

Men Epee

#	Country	Weapon		Body cord		Mask		Mask cord		Lame		Glove		Under plastron		Uniform	
		Pass	Fail	Pass	Fail	Pass	Fail	Pass	Fail	Pass	Fail	Pass	Fail	Pass	Fail		
2	ARGENTINA	5	0	5	0	2	0	0	0	0	0	1	0	1	0	1	0
1	ARMENIA	2	0	2	0	1	0	0	0	0	0	1	0	1	0	1	0
1	AUSTRALIA	2	0	1	3	1	0	0	0	0	0	0	0	0	0	1	0
2	BRAZIL	4	0	4	1	1	0	0	0	0	0	1	0	2	0	2	0
2	CANADA	6	2	4	0	2	0	0	0	0	0	3	0	2	0	2	0
3	CHINA	7	0	7	0	3	0	0	0	0	0	5	0	3	0	3	0
1	DENMARK	4	1	4	0	1	0	0	0	0	0	3	0	1	0	1	0
4	FRANCE	9	8	13	1	4	0	0	0	0	0	8	0	5	0	4	0
3	GERMANY	11	1	8	0	3	0	0	0	0	0	5	0	3	0	3	0
1	HONG KONG	1	3	2	0	1	0	0	0	0	0	3	0	1	0	1	0
4	HUNGARY	12	3	13	1	4	0	0	0	0	0	6	0	4	0	4	0
4	ITALY	15	0	13	0	4	0	0	0	0	0	8	0	5	0	4	0
4	JAPAN	5	8	13	0	4	0	0	0	0	0	6	0	4	0	4	0
4	KAZAKHSTAN	10	1	10	0	3	1	0	0	0	0	3	0	4	0	4	0
4	KOREA	12	0	11	0	4	0	0	0	0	0	3	0	4	0	4	0
2	MALAYSIA	8	1	9	0	4	0	0	0	0	0	6	0	3	0	3	0
4	MONGOLIA	0	0	2	2	4	0	0	0	0	0	5	0	4	0	4	0
2	MALI	8	1	11	0	3	0	0	0	0	0	4	0	3	1	3	0
2	NETHERLANDS	7	0	6	0	2	0	0	0	0	0	5	0	3	0	2	0
3	POLAND	10	0	15	0	4	0	0	0	0	0	6	0	4	0	4	0
2	QATAR	6	0	5	0	2	0	0	0	0	0	2	0	2	0	2	0
4	RUSSIA	12	1	11	0	4	0	0	0	0	0	5	0	4	0	4	0
3	SINGAPORE	6	1	5	0	2	0	0	0	0	0	3	0	2	0	2	0
2	SLOVAKIAN REPUBLIC	3	4	8	4	2	0	0	0	0	0	3	0	3	0	2	0
4	SWEDEN	16	1	14	0	4	0	0	0	0	0	9	0	4	0	4	0
4	UKRAINE	9	1	10	0	4	0	0	0	0	0	5	0	4	0	4	0
4	USA	15	1	12	0	4	0	0	0	0	0	4	0	4	0	4	0

SEMI Commission Competition Report

4 UZBEKISTAN	2	1	2	0	1	0	0	0	0	0	1	0	1	0	1	0
4 VENEZUELA	11	1	12	0	5	0	0	0	0	0	5	0	4	0	4	0
Totals	135	14	143	6	52	1	0	0	0	0	69	0	53	1	51	0
Grand totals		149		149		53		0		0		69		54		51
Percentage reject		9%		4%		2%		0%		0%		0%		2%		0%
Total all weapons	803	53	824	44	270	24	392	30	245	21	352	7	271	1	273	0
Grand total all weapons		856		868		294		422		266		359		272		273
Percentage reject		6%		5%		8%		7%		8%		2%		0%		0%

SEMI Commission Competition Report

EVENT World Championships 2015
CITY MOSCOW
VENUE Olimpiski
Dates Start 13 July 2015 Finish 19 July 2015

SEMI Commission Delegates

Semen RIKHTMAN	RUS
Janet HUGGINS	GBR
Atsushi HARINISHI	JPN

Local staff

Senior Technicians	8
Volunteers	20
Translators	4

SEMI Commission Competition Report

Venue

1 FINALS HALL



Podium and 4 coloured Plate pistes

Greenapple

5

Scoring Boxes

Manufacturer

Allstar

Model

FMA 21

Reels

Allstar/Favero

Video Refereeing

Swiss Timing

Wireless

STM

SEMI Commission Competition Report

Venue

2 Second Coloured Pistes

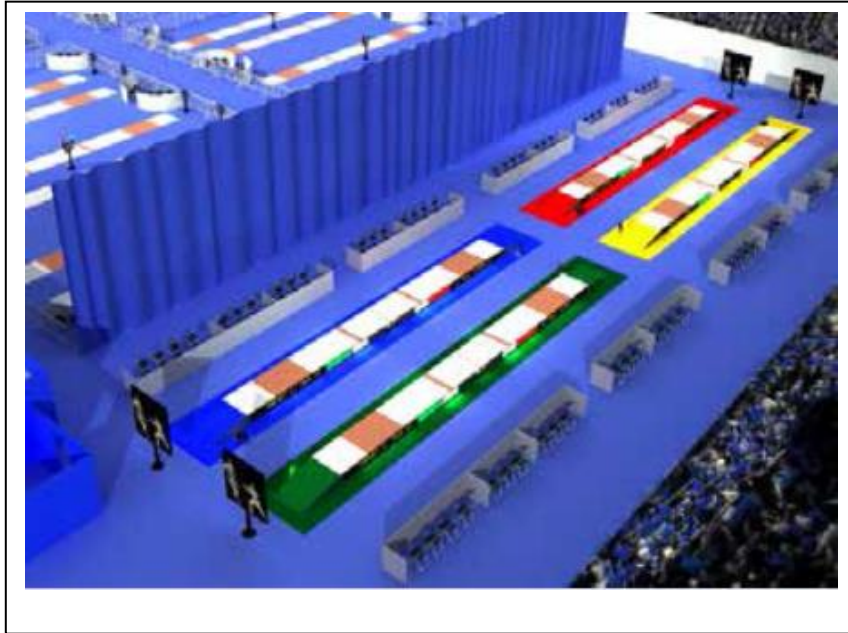

4 coloured Plate pistes

Greenapple

4

Scoring Boxes

Manufacturer

Allstar

Model

FMA 21

Reels

Allstar/Favero

Video Refereeing

Swiss Timing

Wireless

STM

SEMI Commission Competition Report

Venue

3 Preliminary Hall

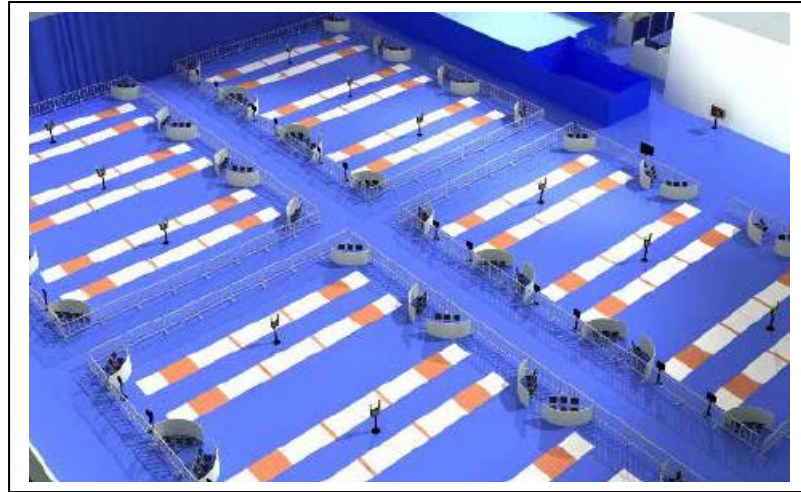

Plate pistes

Greenapple

24

Scoring Boxes

Manufacturer

Allstar

Model

FMA 21

Reels

Allstar/Favero

Video Refereeing

N/A

Wireless

N/A

SEMI Commission Competition Report

4 WEAPON CONTROL

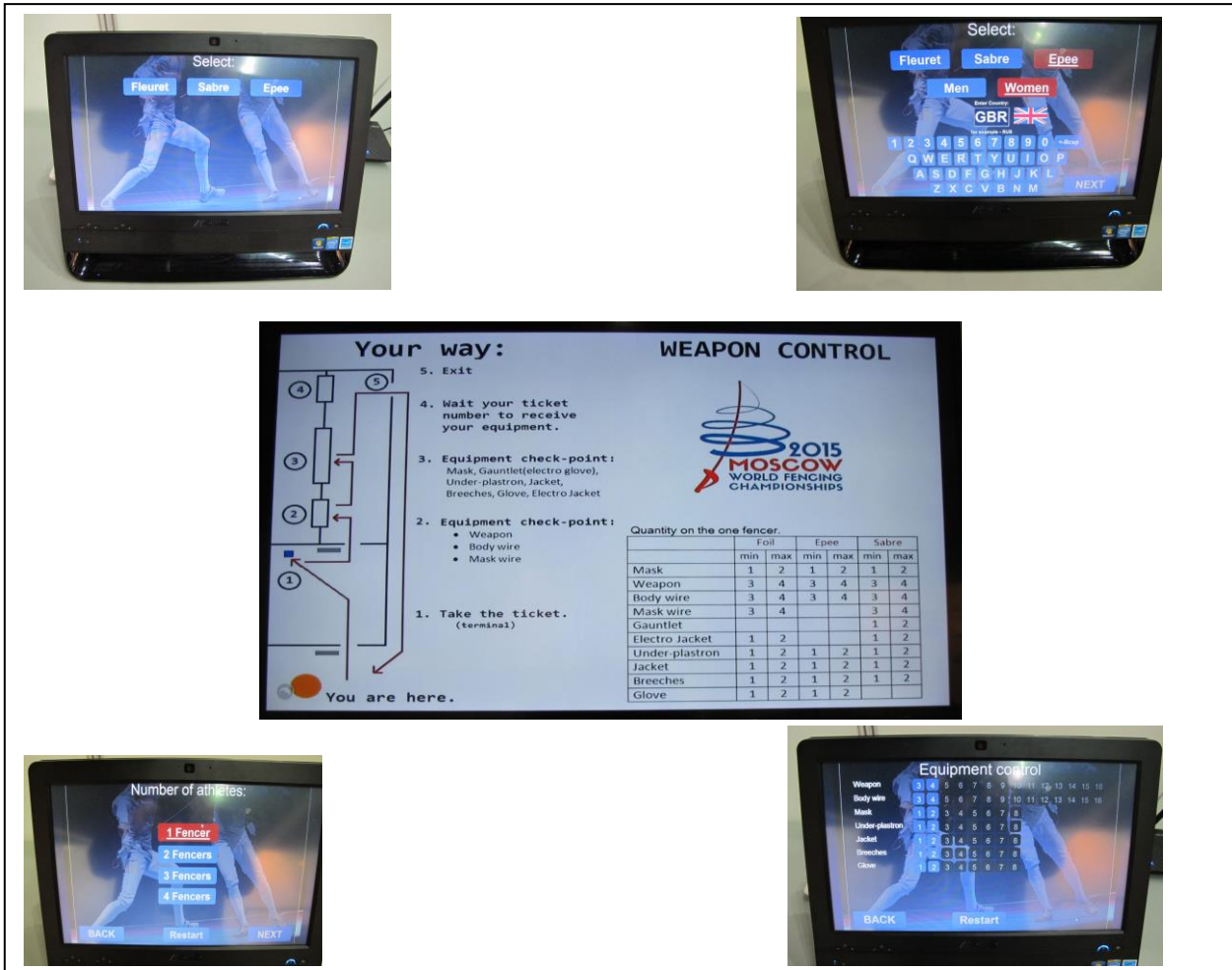

Touch Screen submissions

Testing Equipment

Gabarit	2
Flexibility tester	2
Eddy current	2
Test machines/Multimeters	10
Blade marking /engraving	2
Tags for body/mask wires	Yes
Stamp for clothing	Yes

SEMI Commission Competition Report

Fencing equipment submitted for testing

Weapons

Dimensions	Yes/no*
Homologation	yes
Electrical resistance	no
Insulation of wires	yes
Flexibility	yes
Eddy Current	yes
Conforms to rules	yes

Body/mask wires

Electrical resistance	yes
Soldered joints	yes
Conforms to rules	yes

Mask

FIE Homologation	Yes
Electrical resistance	Yes
Condition and safety	Yes
Conforms to rules	Yes

Clothing

Jackets – Breeches - Plastron	
FIE Homologation	Yes
Condition and safety	Yes
Name and Country	Yes
National Logo	Yes
Publicity	No
Conforms to rules	yes

Metallic jackets – gloves- sabre gloves/overlays

FIE Homologation (Sabre gloves)	Yes
Condition and safety	Yes
Electrical resistance	Yes
Name and Country	Yes
Conforms to rules	yes

SEMI Commission Competition Report

WEAPON CONTROL SYSTEM

Sequential numbering of bags
Items of equipment counted on submission sheet
Bags checked in sequential order
Failed items noted
Passed items marked with control mark
Bags collected on presentation of sheet failures explained
Statistics compiled

Yes
Yes
Yes
Yes
Yes
Yes
yes

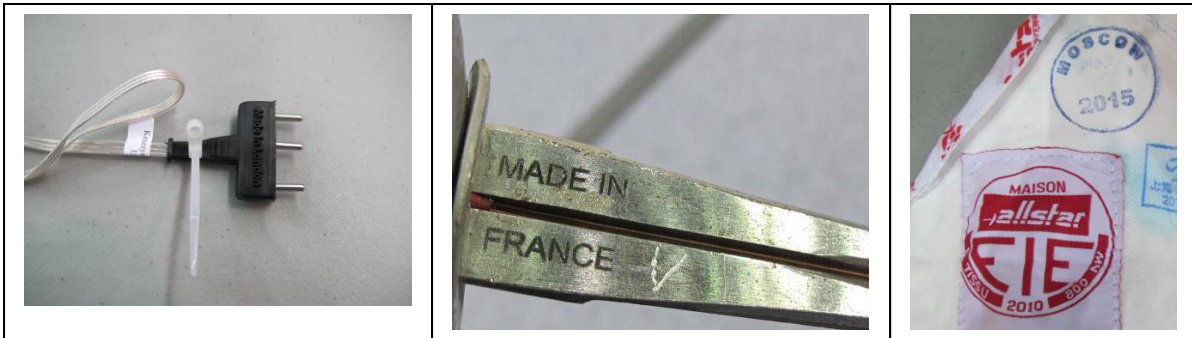

SEMI Commission Competition Report

5 CALL ROOM



Wireless system - STM

Individual Competition Pre-fight checks

Check made for control marks on clothing including plastrons

Yes

Check made for control marks on weapons body/mask wires, masks, metallic jackets and gloves

Yes

Weapons and body/mask wires checked for resistance

Yes

Weapons checked for weight and gauge when appropriate

Yes

Team Competitions - Pre fight checks

Check made for control marks on clothing including plastrons

Yes

Check made for control marks on weapons body/mask wires, masks, metallic jackets and gloves

Yes

Weapons and body/mask wires checked for resistance

Yes

Weapons checked for weight and gauge when appropriate

Yes

Checks made on matching country logos and uniforms

Yes

SEMI Commission Competition Report

Comments

The touch screen submissions system was very successful and the fencers appreciated the fact that the waiting time for the complete controls was very short. The tests were carried out efficiently and quickly. There were no electrical resistance tests or weight & gauge tests made at the initial weapon control, but these checks were carried out at the Call Room stage of the competition.

* Dimension of Sabre points were not checked.

The quality of equipment that was checked was high with no notable major problems. A statistical analysis is given below.

SEMI Commission Competition Report

Equipment control statistics Summary

- Total number of fencers: **1107**.
- Total number of teams: **110**.
- Total number of tickets: **744**.
- Total number of checked equipment: **13534**.
- Total number of Accepted equipment: **12702**.
- Total number of Rejected equipment: **832**.
- Rejected Percentage: **6,1%**.

SEMI Commission Competition Report

Foil

- Total number of fencers: **335 (mens - 207, womens - 127)** .
- Total number of teams: **64**.
- Total number of tickets: **226**.
- Total number of checked equipment: **4679**.
- Total number of Accepted equipment: **4414**.
- Total number of Rejected equipment: **265**.

Rejected Percentage: **5,7%**.

№	Name equipment	Men			Women			SUM		
		Checked	Rejected	%	Checked	Rejected	%	Checked	Rejected	%
1	Weapon	648	20	3,1	387	14	3,6	1035	34	3,3
2	Body wire	527	65	12	359	34	9,5	886	99	11
3	Mask wire	397	45	11	289	14	4,8	686	59	8,6
4	Cond. Jacket	266	6	2,3	193	1	0,52	459	7	1,5
5	Mask	170	8	4,7	114	9	7,9	284	17	6
6	Jacket	188	21	11	119	9	7,6	307	30	9,8
7	Under-plastron	184	1	0,54	131	0	0	315	1	0,32
8	Breeches	182	4	2,2	114	2	1,8	296	6	2
9	Glove	255	10	3,9	156	2	1,3	411	12	2,9
10	Total	2817	180	6,4	1862	85	4,6	4679	265	5,7

SEMI Commission Competition Report

Sabre

- Total number of fencers: **326 (mens - 186, womens - 140)** .
- Total number of teams: **61**.
- Total number of tickets: **211**.
- Total number of checked equipment: **4190**.
- Total number of Accepted equipment: **3884**.
- Total number of Rejected equipment: **306**.

Rejected Percentage: **7,3%**.

№	Name equipment	Men			Women			SUM		
		Checked	Rejected	%	Checked	Rejected	%	Checked	Rejected	%
1	Weapon	424	47	11	332	31	9,3	756	78	10
2	Body wire	473	57	12	377	39	10	850	96	11
3	Mask wire	372	34	9,1	330	22	6,7	702	56	8
4	Cond. Jacket	206	5	2,4	159	5	3,1	365	10	2,7
5	Mask	170	9	5,3	125	6	4,8	295	15	5,1
6	Jacket	159	11	6,9	116	24	21	275	35	13
7	Under-plastron	158	0	0	123	0	0	281	0	0
8	Breeches	160	8	5	114	3	2,6	274	11	4
9	Glove	229	4	1,7	163	1	0,61	392	5	1,3
10	Total	2351	175	7,4	1839	131	7,1	4190	306	7,3

SEMI Commission Competition Report

Epee

- Total number of fencers: **446 (mens - 263, womens - 183)** .
- Total number of teams: **88**.
- Total number of tickets: **307**.
- Total number of checked equipment: **4665**.
- Total number of Accepted equipment: **4404**.
- Total number of Rejected equipment: **261**.

Rejected Percentage: **5,6%**.

№	Name equipment	Men			Women			SUM		
		Checked	Rejected	%	Checked	Rejected	%	Checked	Rejected	%
1	Weapon	800	46	5,8	535	38	7,1	1335	84	6,3
2	Body wire	688	67	9,7	485	45	9,3	1173	112	9,5
3	Mask wire	0	0	0	0	0	0	0	0	0
4	Cond. Jacket	0	0	0	0	0	0	0	0	0
5	Mask	229	10	4,4	160	11	6,9	389	21	5,4
6	Jacket	243	12	4,9	164	10	6,1	407	22	5,4
7	Under-plastron	242	1	0,41	170	0	0	412	1	0,24
8	Breeches	239	5	2,1	164	3	1,8	403	8	2
9	Glove	331	6	1,8	215	7	3,3	546	13	2,4
10	Total	2772	147	5,3	1893	114	6	4665	261	5,6

SEMI Commission Competition Report

Semen RIKHTMAN	RUS
Janet HUGGINS	GBR
Atsushi HARINISHI	JPN

Date 19.July 2015



SEMI COMMISSION COMPETITIONS REPORT.

Event: PANAMERICAN GAMES TORONTO 2015

Venue: CANADA. City: TORONTO.

Dates: JULY. Start: 17 Finish: 26.

SEMI Commission Members:

- | | | |
|-----------|----------|-------------------|
| 1. Maria | EBERL L. | SEMI. FIE. |
| 2. Tim | STANG | SEMI. CANADA. |
| 3. Denis | MARTEL | ARMERO CHIEF. |
| 4. Mike | KASUNIC | ARMERO ASSISTANT. |
| 5. Joseph | CHENG | ARMERO ASSISTANT. |
| 6. Todd | CASLICK | ARMERO ASSISTANT. |
| 7. David | BLAKE | ABSOLUTE FENCING. |
| 8. Wng | ZHIQIANG | ABSOLUTE FENCING. |

Venue.

1.- FINAL HALL.





Plate Pistes.	Manufacturer.	Piste Number.
	Absolute Fencing.	5.
Total.		5.
Scoring Boxes.	Make: KABKOM ALLSTAR.	5.
	Model	
Reels.	Make: FAVERO.	20.
Video Refering	Make: ATOS.	5.

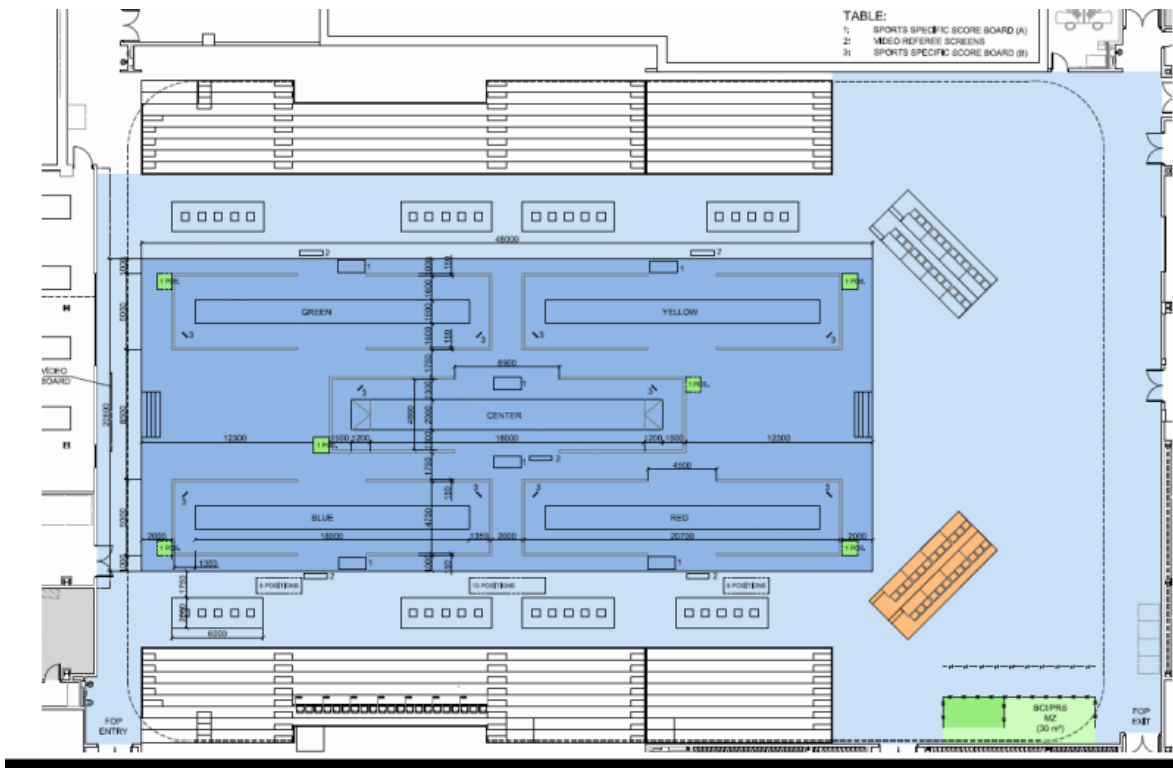



2.- PRELIMINARY HALL.



Plate Pistes.	Manufacturer.	Piste Number.
	Absolute Fencing.	5.
Total.		5.
Scoring Boxes.	Make: KABKOM ALLSTAR.	5.
Reels.	Make: FAVERO.	20.

3.- WEAPONS CONTROL.





a.- Test & marking equipment.

	Make	Number
Gabarit	Absolute Fencing	3
Flexobility tester	Absolute Fencing	3
Eddy Current		No
Test machine/ Multimeter	Favero	8
Blade marking Etching/ engraving		No
Tags & Label for bodu wire		Yes
Stamp for cloting		Yes



b.- Fencing equipment submitted for testing.

WEAPONS	Dimensions	Yes
	FIE. Homologation	Yes
	Electrical resistance	Yes
	Insolation of wire	Yes
	Flexibility	Yes
	Eddy concurrent	No
	Conforms to rule	Yes
BODY/MASK WIRE	Electrical resistance	Yes
	Sodered joints	Yes
	Conforms to rule	Yes
MASK	FIE. Homologation	Yes
	Electrical resistance	Yes
	Conforms to rule	Yes
CLOTHING	Jackets-Breches-Plastrons	Yes
	FIE. Homologation	Yes
	Condition & Safety	Yes
	Name & Country	Yes
	Country Logo	Yes
	Publicity	Yes
	Conforms to rule	Yes
	Metallic Jackets-Globes-Sabre Globes-Sabre overlays	Yes
	FIE. Homologation Sabre Globes - Globes	Yes
	Condition & Safety	Yes
	Name & Country	Yes
	Electrical resistance	Yes
	Conforms to rule	Yes



c.- Weapon Control System.

Sequential numbering of bags	No
Item of equipment counted & checked on submission sheet	No
(Original and copy retained with bag copy to person submitting bag)	
Bags checked in sequential order	No
Failed items noted on failure sheet	No
(Original retained by weapon control copy to person reclaiming bag)	
Passed items marked with control mark	No
Bags collected upon presentation of copy submission sheet	No
(items counted and failures explained)	
Submission and failure sheets used to compile statistics	No

4.- Call Room.

Wireless System	Make	
-----------------	------	--

Individual Competitions – Pre – Fight Checks

Check made for control marks on clothing including plastrons	Yes
Check made for control marks on weapons body/mask wires, mask, metallic jackets and gloves	Yes
Weapons and body/mask wires checked for resistance	Yes
Weapons checked for weight gauge when appropriate	Yes

Team Competitions – Pre - Fight Checks.

Check made for control marks on clothing including plastrons	Yes
Check made for control marks on weapons body/mask wires, mask, metallic jackets and gloves	Yes
Weapons and body/mask wires checked for resistance	Yes
Weapons checked for weight gauge when appropriate	Yes
Check made on matching country logo and uniforms	Yes



COMMENTS

A mi llegada, el grupo de Control de Armas ya estaba trabajando, visto que les encomendaron la tarea de controlar el material de esgrima de los competidores de Pentatlón Moderno, el coordinador de armería, no contaba con los formularios (marcado de bolsos, recepción y rechazo de material, etc) ni un lugar donde implementar debidamente el Protocolo emanado desde la FIE, no obstante el jefe de armería, se comprometió a entregar los datos estadísticos de la revisión de armas y implementación, el trabajo realizado por el equipo fue excelente por profesionalismo, disponibilidad y gentileza en el cumplimiento de su labor específica, a solicitud del Directorio Técnico, fue el personal de Control de Armas, el encargado de revisar el material de los competidores antes de ingreso a las peanas tanto en la Poulès, como el cuadro de eliminación, con cuatro estaciones, las cuales contaron con todos los implementos necesarios, para esta labor.

El material de marcado fue:

- Sticker en las Armas. **“FE TORONTO 2015”**
- Amarra plásticas en los Cables de Cuerpo y Mascara.
 - ✓ Color Rojo, con marca **“FE TO2015”**
- Estampado con un Timbre, en las Tenidas, Chaquetas Eléctricas, medias y Guantes.
 - ✓ **“FE TORONTO 2015”**

Un grupo de 16 voluntarios específicos, se encargó del transporte de los bolsos con el material de los deportistas, desde la Cámara de llamado a las pistas, ida y vuelta, bajo la supervisión del Sr. Denis MARTEL, los bolsos en este caso llevaban un Adhesivo con los nombres de los deportistas.

Durante el evento por equipos, se encontraban presente en al final de cada Pista un miembro de Control de Material, asegurando así el buen y rápido desarrollo de las Pruebas.



INSIDENTES:

El deportista Brasileño, ZEYTOUNLIAN Willian, tiene la costumbre de poner y sacar la máscara inversamente (adelante) por lo que la placa de metal trasera no está como es debido, usarla; el velcro, está en condiciones extraordinarias, pero el competidor lo afirma, solo en un mínimo borde, por lo que los constantes movimiento, provocaron que se soltara.

El excelente grupo de trabajo en el Chequeo de material,, quedo en tela de juicio por la seguridad, pero en este caso puntual, es responsabilidad de los técnicos el enseñar que con la seguridad no se juega; del deportista por no respetar su integridad física a cambio de la comodidad de su equipo; del árbitro por no asegurarse que esta estuviera como corresponde para iniciar el combate.

Yo estaba en la sala de control, en el momento que se realizaron los chequeos de material, y doy fe, que este fue riguroso en todo momento.

Upon my arrival, the group Arms Control was working, they saw that they entrusted the task of controlling the material fencing competitors of Modern Pentathlon, the coordinator armory, he did not have the form (marked bags, reception and rejection of material, etc.) or a place to properly implement the Protocol emanated from the FIE, however armory chief, pledged to provide statistical data of weapons and reviewing implementation, the work of the team was excellent by professionalism, availability and courtesy in meeting the specific work sula, at the request of the Technical Board, was the Arms Control staff, responsible for reviewing the material of the competitors before entering the bases both Poules like removal box with four stations, which counted with all the equipment necessary for this work.

The marking material was:

- Sticker on weapons. "TORONTO 2015 FE"
- Tie the cables in plastic body and Mascara.
- Red, branded "FE TO2015"



- Stamped with a bell in the stained, Power Jackets, socks and gloves.

□ "TORONTO 2015 FE"

A specific group of 16 volunteers, was in charge of transporting the bags with the material of athletes, from the House called to the slopes and back, under the supervision of Mr. Denis MARTEL, in this case bags carried a sticker with the names of the athletes.

In the team event, they were present at the end of each track member Material Control, thus ensuring the smooth and rapid development of the tests.

INSIDENTES:

The Brazilian athlete, Willian ZEYTOUNLIAN, has a habit of putting and removing the mask inversely (below) so the rear metal plate is not as it should, use it; Velcro is under extraordinary conditions, but the competitor says, only a minimal edge, so that the constant movement caused that was released.

The excellent working group in the material ,, stay Check questioned by security, but in this specific case, it is the responsibility of the technical teaching that safety is not played; the athlete for not respecting their physical integrity in exchange for the comfort of your computer; Referee not sure this was accordingly to initiate combat.

I was in the control room at the time that the material is made checks and attest that this was rigorous at all times.

TOTAL: 2098 Equipos Revisions.,

Defectuosos. 187.

Pasaron 1911.

Porcentaje de malo. 3%.



ICAN GAMES TORONTO Summary Weapon Control - Event Date 2015

Sabre		Epee		Foil		Fil de Corps		Fil de Masque		Masque		Lame Jacket		Glove		Jacket		Breeches		Plastron		TOTAL ITEMS			
Pass	Fail	Pass	Fail	Pass	Fail	Pass	Fail	Pass	Fail	Pass	Fail	Pass	Fail	Pass	Fail	Pass	Fail	Pass	Fail	Pass	Fail	Pass	Fail		
114	28	121	25	159	30	432	50	155	18	136	6	76	5	151	8	140	6	148	3	128	0	1911	187		
																							0	0	
																								0	0
																								0	0
																								0	0
																								0	0
																								0	0
																								0	0
																								0	0
																								0	0
114	28	121	25	159	30	432	50	155	18	136	6	76	5	151	8	140	6	148	3	128	0	1911	187		

Dear friends, unfortunately, the Congress passed in Regulation a nonsense.

”The hardness of the outside of the material must be 20-30% hardness. This is the typical hardness of wet suit material for scuba diving (neoprene)”.

Let us clarify our ideas and take a overlook on this material.

The neoprene is used for the diving suit, is marketed with different density and thicknesses.

Synthetic Elastomeric (technical name Polychloroprene), look like a foam, lined externally by two layers of nylon to increase the resistance of the material, per se brittle.

Is a material that is easily to paste and which has a good elasticity to be easily shaped.

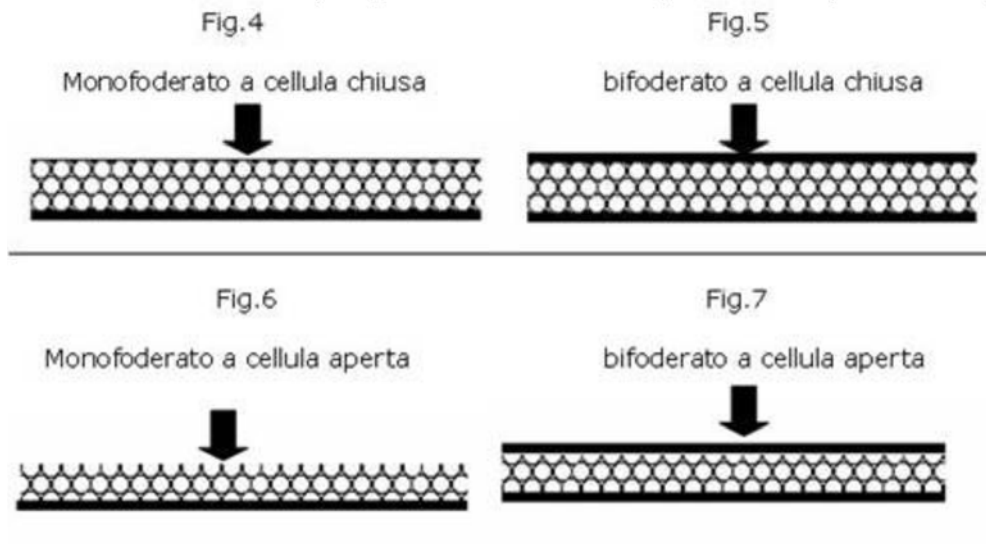

For the diving suit the kind of Neoprene is the double linen with closed cell (Fig. 5): for temperate seas we use a wetsuit of 5 mm thickness and with medium foam for cold seas the thickness is 6/7 mm always with medium foam.

The hardness of the elastomers is measured by the scale Shore (var. A from 0 to 100).

Take a look on:

<http://www.atp-messtechnik.de/pg/Shore-oder-Durometer/423?MODsId=823eba5767dd9ce78253e8f2383e4833>

<http://www.samatools.it/product/512/Stativo-manuale-per-duometri-shore-analogici-tipo-A-e-E.html>

Measuring the hardness of a neoprene sample of rubber is an imprecise art. Depending on the durometer in use and the competence of its operator, it is possible (even probable) that the same sample will produce two or more different readings. The speed at which the hardness tester is applied to the sample, the force used, the amount of time (normally at least 10 seconds) that elapses before it performs the reading, and the temperature of the sample, can influence a test result. For this reason, all the readings of durometer normally include a tolerance of ± 5 points, but sometimes this may not be sufficient to completely predict all variables. Generally it is a good idea to test a given sample several times and generate an average of the results to ensure accuracy.

So I propose the use of a sheet of 5 mm double linen for the chest protector (low cost and readily available). We have to collect several samples and to measure all the samples, so we can establish a range of hardness (it can it might be okay values between 30 and 50 of the scale ShoreA). The problem to be evaluated is that this material is made to hold the heat efficiently. This can be a serious detriment to our fencers.

PROPOSALS SUBMITTED TO THE ATHLETES COMMISSION 2015 CONGRESS

MODIFICATIONS OF THE STATUTES

Proposals of the Executive Committee

Proposal 6

Motivation: Aligning the Athletes Commission at meetings organized by the FIE on other Commissions.

6.4.4 For the Athletes Commission, which is meeting in accordance with Articles 6.2.4 and 6.4.1 ~~the member federation of each member will be responsible for the costs of transportation and lodging necessary for the athlete to take part in the meetings of the commission~~, the FIE financial support is the same as for the other commissions and on the same conditions.

Opinion of the Athletes Commission: In favor.

Proposals of the Legal, Medical and PP Commissions and Women and Fencing Council

Proposal:

That the minimum representation of men and women on the FIE Executive Committee and all FIE Commissions and Councils should be raised from 20% to 30%.

Rationale:

In 2007 the Olympic Charter was amended to include, for the first time in history, the following:

"The IOC encourages and supports the promotion of women in sport at all levels and in all structures, with a view to implementing the principle of equality of men and women."
Rule 2, paragraph 7, Olympic Charter in force as from 07.07.2007

The International Olympic Committee (IOC) has publically committed itself to increasing the number of women occupying leadership positions within the Olympic Movement. Twelve years ago, in 2003, the FIE Congress took the decision to require minimum representation of 20% of men and women on the FIE Executive Committee and all FIE Commission.

In line with the commitment of the IOC and best practice in organisational governance, it is now time to increase gender balance in the FIE by increasing the minimum representation of men and women on all FIE Commissions and Councils to 30%.

Proposed changes to FIE Statutes:

Proposal 1

4.3.4: In order to secure the principle of equal treatment, women and men must be represented in overall view by at least ~~20~~ 30% of the elected members of the Executive Committee. If the 15 candidates who have obtained the most votes do not include at least ~~3~~ 5 persons of each gender, the Executive Committee will consist of the ~~3~~ 5 candidates for the Executive Committee who have obtained the greatest number of votes of the gender not otherwise being so represented and the ~~12~~ 10 candidates of the other gender who have obtained the greatest number of votes.

If there are less than ~~3~~ 5 candidates of either gender, that gender will be represented by the number of candidates put forward and the remainder of the Executive Committee will consist of the candidates of the other gender who have obtained the most votes.

Proposal 2

4.4.4: If the 10 first members elected do not include ~~two~~ 3 members of each gender, the Commission will consist of the first ~~8~~ 7 members elected and the ~~two~~ 3 members of the other gender who are candidates for the commission and who have obtained the greatest number of votes. If no candidate of either gender has offered herself/himself as candidates, the 10 candidates of different nationalities with the greatest number of votes are elected.

PROPOSALS SUBMITTED TO THE ATHLETES COMMISSION 2015 CONGRESS

MODIFICATIONS TO THE RULES Proposals of the Executive Committee

Proposal 1

Motivation: Update of the Publicity Code in line with standards that are closer to reality and harmonised with those of the IOC.

MARKS

p.9 Definition

The **mark** is the name or badge which identifies the origin, the manufacturer or the seller of a particular piece of the fencer's equipment.

As soon as the mark exceeds the normal or authorised dimensions, it becomes an **advertisement** and comes under the jurisdiction of the regulation below. (Cf. p.12)

p.10 Position and sizes

- 1 The articles of the fencers' **equipment** may carry the following visible marks:
 - a) **mask**: one mark on the rear of the spring. Maximum size: ~~6 x 5.5 cm~~ 12.5 cm².
 - b) **jacket**: one mark at the bottom of the jacket on the hip on the side of the non-sword arm. Maximum size: ~~4.5 x 2 cm~~ 30 cm².
 - c) ~~breeches~~ trousers: one mark at the bottom ~~of the breeches of the trousers~~, on one side only. Maximum size: ~~4.5 x 2 cm~~ 30 cm².
 - d) **stockings socks**: one mark on each ~~stocking sock~~. ~~in size 4.5 x 2 cm~~. Maximum size: 10 cm².
 - e) **shoes**: the name of the brand on each shoe. Maximum size: ~~4.5 x 2 cm~~ 10 cm² or the usual logos (e.g.: bands).
 - f) **glove**: ~~no mark~~. One mark: maximum size: 10 cm². If the mark is affixed on the glove with the help of a label (glued or sewn), the latter must be placed on the cuff.
 - g) **weapon**: ~~no mark visible at a distance. One mark~~. Maximum size: 2.5 cm².

- h) **electric jacket:** one mark at the bottom of the jacket on the hip of the side of the non-sword arm. Maximum size: 30 cm².

Application as follows: 1st of January 2016

Opinion of the Athletes Commission: In favor.

Proposal 2

Motivation: Allowing fencers to take advantage of potential sponsors.

p.12

2 Fencing clothing and equipment

- a) If a federation and/or a fencer have signed a **sponsorship contract** with a commercial or other company, the logo of that sponsorship partner, maximum 125 cm² in size, may be affixed at the top of the sleeve of the fencing jacket (non-sword arm), on the side of the trousers (left or right), or on the socks. At sabre, a logo may not be worn on the sleeve.

The sponsor(s) logo may be displayed on each side of the mask. Maximum size: 100 cm² on each side of the mask.

- b) The **number of logos** shall not exceed ~~four~~ five. The **total surface** of all logos added together may not exceed a total of 500 square centimetres.

Application as follows: 1st of January 2016

Opinion of the Athletes Commission: In favor.

Proposal 3

Motivation: The following is no longer part of common practice. Furthermore, it may provoke conflicts with the sponsors of athletes or federations. Therefore, the proposal is to remove the following articles from the Publicity Code:

~~p.12.5.b) As far as possible, the **organisers** must make it clear, in the conditions of entry for the competition, the way in which advertising material worn or carried by the fencers will be permitted.~~

~~LEG-BAND OR SELF-ADHESIVE NOTICE~~

~~p.13~~

~~1 Principles~~

~~a) The organisers of a competition may identify the fencers by issuing them with a number on a **leg-band** or on a **self-adhesive badge**.~~

~~b) In such a case, the wearing of this **band** or **badge** is obligatory for the fencers.~~

~~c) The **self-adhesive badge** must be of a rough material which will not cause the point to slip.~~

~~d) The **leg-band or self-adhesive badge** may have on it advertising material within the limitations of the rules below.~~

~~e) The **circular** announcing the details of the competition must make clear what bands or badges the fencers are to wear, and what publicity will be on them.~~

~~Entering the competition implies an acceptance by the fencer of the obligation to wear the band or badge in question.~~

~~2 Position and size~~

~~a) The **leg-band** must be fixed to the thigh on the side of the non-sword arm. The maximum **size** of the leg-band is of 20 x 20 cm. The fencer's number must be at least 10 cm high and 15 cm in width.~~

~~b) The **self-adhesive badges** must be fixed to both sides of the mask, on the side mesh.~~

~~The maximum **size** of the badges must be 10 cm wide by 15 cm high. The fencer's number must be no more than 8 cm high by 8 cm wide. At foil and épée only the self-adhesive badge of the competition taking place must be worn.~~

~~c) In both cases, **the advertising**, words or badge, must be placed below the number and must not exceed 35 mm in height.~~

~~d) If the self-adhesive badge on the mask **does not include a number**, it may only be used for advertising following agreement with the FIE.~~

Application as follows: 1st of January 2016

Opinion of the Athletes Commission: In favor.

Proposal 7

Motivation: For the junior World Championships, increase the number of athletes in individual events to equal the one for entries to the junior's team events.

o.72

For the cadets World Championships, entries are limited to **three fencers per nation** for the individual events.

For the juniors World Championships, the entries are limited to **four fencers per nation** for each individual event, and **one team per nation** for the team events.

Application as follows: 1st of January 2016

Opinion of the Athletes Commission: In favor.

Proposal 11

Motivation: During tests performed in 2009, it was established that the adequate blocking time allowing for spectacular actions, such as the parry and the riposte, is situated between 160 and 180 milliseconds. It has been, therefore, proposed to change the current time to 170 milliseconds.

ANNEX B

CHARACTERISTICS OF EQUIPMENT

C) SABRE

a) Principles

1) to 7), no change.

8) After a hit has been registered, a subsequent hit made by the other fencer will only be registered if it occurs within a maximum of ~~120~~**170 milliseconds** (± 10 ms tolerance).

9) and 10), no change.

Application as follows: vote during the 2015 Congress and, if the change is adopted, application starting with the season 2016-2017.

Opinion of the Athletes Commission: In favor. However it must be noted that this change would make matches harder to referee hence the commission proposes to test intensively by the referees as soon as it is approved. Clearer explanation is expected if the safety of athletes is the largest reason for this change. The commission also considers that constant changes in few years would not only affect the fencers but also the technical development of saber.

Proposal 12

Motivation: Reintroducing the fleche for the sabre, because it is a spectacular action and it should be allowed for this weapon, as long as it is perfectly explained to referees so that they don't equate it to another action.

t.75

5 - The **step forward**, ~~the fleche~~ and any forward movement **in which the rear foot completely passes the front foot is forbidden**. Any offence will be penalised as specified **for penalties in the 1st group (cf. t.114, t.116 and t.120)**. Any hit scored by the fencer at fault will be annulled. However, any hit correctly executed by his opponent is valid.

Application as follows: vote during the 2015 Congress and, if the change is adopted, application starting with the season 2016-2017.

The proposal has been withdrawn.

Proposal 13

It would be helpful for the fencing world to consider a new sensor for the sabre, using available technologies.

The old sensor was a mechanical sensor (physical contact).

A small steel ball was held by two springs in a small metal pipe. When the hit reached its target with sufficient force (500 g), the ball moved and closed the circuit.

Numerous problems were immediately identified:

- If the movement was perfectly linear, the ball did not touch the pipe and did not close the circuit.
- The 500 g varied depending on the springs used by the manufacturer and their age, therefore, there could be differences from one weapon to the other.
- The greater the tilt of the blade, the less the sensor worked.

With the new, inexpensive technology derived from the automotive industry, we are able to start considering the production of a new electronic sensor using MEMS.

The **MEMS (Microelectromechanical Systems)** technology is the technology of very small devices; we are talking of the nanometric scale of nanoelectromechanical systems (NEMS) and of nanotechnology.

Today, the MEMS are mainly used to detect movement inside mobile elements, for example, air bags, smartphones, GPS. In sports, they are used in tennis, golf, and baseball.

The final product will be a square with sides of approximately 25 mm and 4/6 mm thickness. It will include a battery, one or two MEMS, and electronic circuits for power supply and the MEMS. It will be easy to place in the sabre guard.

The project will have to involve a specialised company and/or a university laboratory as the 1st trial. The development phase of the software is long and complicated, as is always the case when developing low level software.

The SEMI Commission may coordinate the sports aspects of the project (specification of data to be collected, and trials on the piste).

STAGES OF THE PROJECT

- ▶ Measurement of loads, limitations, speed, and energy absorbed during typical real attacks, using adapted sabres. HD video recording of attacks. Data analysis. Determining the minimum force of the hit (500 g) and possible decisions to prevent hits in certain specific directions (for example, rectilinear, with only the button).
- ▶ Selection of suitable MEMS (1 or 2). Development of a prototype and verification of the utility of output data. Development of a software to control the MEMS. Creating a sample for the performance of limited tests (10/12 trials) on the piste. Correction of any software errors.
- ▶ Resistance test with the production of 200/250 samples to be given to one nation for a period of at least 6 months (preferably an entire season). Correction and improvement of final software.

Opinion of the Athletes Commission: Not in favor. The commission expects more explanation and investigation to understand the motivation and reason for utilizing the new technology.

Proposals Refereeing Commission

The Referees Commission is proposing follow modifications

Proposal 3

Technical Rules:

t.18.5. The order 'Halt!' is also given if the play of the competitors is **dangerous, confused, or contrary to the Rules**, if one of the competitors is **disarmed or steps off the piste**, or if, while retiring, he approaches too near the spectators or the Referee (cf. t.26, t.54.5 and t.73.4.j).

At foil it is forbidden, during the course of fencing, to advance the shoulder of the non-sword arm in front of the shoulder of the sword-arm (cf.t.19). Any hits scored by the fencer at fault while committing this offence will annulled.

Opinion of the Athletes Commission: In favor with the condition of having more investigations by the referee commission to set more precise rules.

Proposal 4

t.120 cat 1: Reversing the line of the shoulders.

Reason:

- This modification would made more clear the decisions of the referee. It is mostly a "grey zone" and an interpretation whether the non-sword arm is covering the valid target.
- If the fencer is turning in the non-sword shoulder so in same time is not more visibly by the camera what he is doing with his non-sword hand.

Opinion of the Athletes Commission: In favor.

Deferred Proposals

1. Deferred proposal of the Hungarian Fencing Federation

Motivation:

It is merely a clarification of an existing rule, more precisely that the fencer must not be penalised by one meter unless he crosses the lateral boundaries of the piste with two feet.

t. 17.9

The return on guard, at a distance, for a **lateral exit of the two feet** may place the opponent committing the error on the other side of the rear line and lead to a hit.

Opinion of the working group 2015 (Rules, Refereeing, Promotion Commissions, Coaches Council, Athletes Commission) in charge of reviewing the proposal deferred in 2014:

The text proposed by the Rules Commission in English is preferable, but the English text will have to be adapted for application in French. The new French text proposed is the following:

If a fencer crosses the lateral boundaries of the piste, with one or two feet, he must be placed on guard at the correct distance, even if this means that he is placed behind the rear line and causes a hit to be awarded against him. (cf t.28, t.102).

Opinion of the Athletes Commission: In favor.

2. Deferred proposal of the Russian Fencing Federation

Motivation:

Reducing the number of simultaneous attacks for sabre. Increasing the number of actions in order to make matches more spectacular.

t.17.

1. For foil and épée, ~~the~~ **The Referee places** each of the two competitors in such a way that the front foot of each is 2 metres from the centre line of the piste (that is, behind the 'on-guard' lines).

2. For sabre, the referee places each of the two competitors in such a way that the back foot of each is 2 m from the centre line of the piste (that is, in front of the "on-guard" lines).

Opinion of the working group 2015 (Rules, Refereeing, Promotion Commissions, Coaches Council, Athletes Commission) in charge of reviewing the proposal deferred in 2014:

The object of this proposal is to reduce simultaneous attacks at sabre. An ad hoc commission must be nominated by the Executive Committee as soon as possible, with the task to obtain statistics regarding simultaneous attacks during the rest of the 2015-16 season.

The working group is in favour of the proposal to organise tests, by introducing the rules proposed by the Russian Federation as temporary rules for all categories at sabre, men and women, during the period from the start of the 2016-2017 season until 31 December 2016.

The ad hoc commission will study the tests through comparisons with the statistics from the previous season. It will deliver its opinion at the end of 2016 to the Executive Committee, which will decide if the rule will be applied for the rest of the 2016-17 season.

The correct numbering of the articles in the proposal is t.17.2.a and t.17.2.b

Opinion of the Athletes Commission: Not in favor. The commission thinks that making a closer distance would not directly lead to the effect of reducing simultaneous actions, and rather wishes to define attacks clearly for referees with consistent judgement.

3. Deferred proposal of the Swedish Fencing Federation

Adjustment of calculation procedure for individual and teams world ranking during the year following the Olympic Games (o.83 and o.84)

Motivation:

Participation in the Olympic Games is very limited. However, the multiplying factor for points attributed during the Olympic Games is of 3 for the individual competition and 2 for the teams competition (World Cup: 1; Grand Prix: 1.5; and World Championships: 2). This leads to an imbalance in the world rankings during the year following the Olympic Games, which is not corrected prior to the next World Championship, which can have even more lasting consequences on the ranking.

Opinion of the working group 2015 (Rules, Refereeing, Promotion Commissions, Coaches Council, Athletes Commission) in charge of reviewing the proposal deferred in 2014:

The working group recognises that there is a problem with the official FIE rankings during the season following the Olympic Games. In particular, in all Olympic teams competition participation is very low, which gives too much protection to participating teams and causes immobility in the rankings during the season following the Games.

The intention of the proposal formulated by the Swedish Federation to find a solution to this problem has also been mentioned by the Athletes Commission. However, the Athletes Council and the working group do not consider it appropriate to entirely cancel the results of the Games in the rankings of the new season.

The working group proposes that the multipliers be adjusted in order to reduce the consequences of the limited participation to the Games, and to improve the initial rankings of the competitions during the new season following the Olympic Games. The opinion of the working group is that the following multipliers are suitable:

The group proposes the following text in the Rules:

o.83.2 Individual ranking

b) The different competitions are attributed the following multipliers

Competition	Individual competitions
Olympic Games	2
World Championships	2
Grand Prix	1.5
Zonal Championships	1
World Cup	1

~~b) Points obtained in an individual A Grade World Cup competition have a multiplying factor of 1.~~

~~c) Points obtained in a Grand Prix competition of the FIE and a Zonal Championship are multiplied by a factor of 1.5.~~

~~d) Points obtained in the individual events of the Senior World Championships and in the Junior World Championships are multiplied by a factor of 2.5.~~

~~c) e) Points obtained in the individual events of the Olympic Games are multiplied by a factor of 3.0.~~ At the **Olympic Games**, the 4th is awarded ~~54~~ **36** points.

d) ~~f)~~ Only fencers who have **actually participated** in a direct elimination table can receive any points.

Opinion of the Athletes Commission: In favor.

4. Deferred proposal of the Swedish Fencing Federation

o.84.2 Team scale of points

b) The different competitions are attributed the following multipliers

Competition	Multiplier
Olympic Games	1.5
World Championships	1.5
Zonal Championships	1

World Cup	1
-----------	---

~~b) For the World Team Championships, the points indicated above are multiplied by two.~~

~~c) Points obtained in a Zonal Team Championship have a factor of 1.0.~~

Opinion of the Athletes Commission: In favor (by majority). The discussion was divided into "in favor" and "not in favor" by the members as some of the continents would lose much scores by changing multipliers.

5. Deferred proposal of the Swedish Fencing Federation

Creating a cycle for the Olympic programme, based on the principle of gender equality and equality between the different weapons (o.48.1)

Motivation:

The situation in which there are ten gold medals attributed to fencing at the Olympic Games continues since 2004, and there is no sign that the number of medals will increase. To this day, the Congress has taken decisions in what regards the Olympic programme three years in advance (for example, in November 2013 for the Olympic Games in Rio in 2016). It is clearly too late to allow athletes and national federations to prepare and plan their activities in a structured manner.

Consequently, it is desirable to clearly establish in our rules the Olympic programme cycle, in order to ensure stability and equity between the genders and the different weapons.

The Swedish Fencing Federation proposes the continuation of the cycle applied for the Olympic Games in Beijing, London, and Rio de Janeiro.

Opinion of the working group 2015 (Rules, Refereeing, Promotion Commissions, Coaches Council, Athletes Commission) in charge of reviewing the proposal deferred in 2014:

The working group is in favour of the proposal, but there seems to have been a misunderstanding concerning the structure of the proposed cycle. This proposal provides balance between the weapons and the genders in the current situation, even if it is very important to obtain two additional medals. The working group proposes the following cycle:

Programme of competitions

o.48

1. The programme of fencing events at the **Olympic Games** currently comprises 10 events. Given that the situation does not allow for organising 12 events, the programme of team events at the Olympic Games varies so that two weapons per team are not included during each Olympic year. For events not included in the Olympic programme, the FIE will organise World Championships.

The team competitions cycle at the Olympic Games will be:

Olympic Games 2016: Men's foil, men's épée, women's épée, women's sabre. (In the case of women's foil and men's sabre, the FIE will organise World Championships.)

Olympic Games 2020: Women's foil, men's épée, women's sabre, men's sabre. (In the case of men's foil and women's épée, the FIE will organise World Championships.)

Olympic Games 2024: Women's foil, men's foil, women's épée, men's sabre. (In the case of women's and men's épée, the FIE will organise World Championships.)

The cycle described above is continued for the following Olympic Games (2028, 2032, ...)

Any change to the above cycle or to the number of events must be approved by the Congress.

Opinion of the Athletes Commission: In favor.



INTERNATIONAL FENCING FEDERATION (FIE)

MINUTES COACHING COUNCIL MEETING

- **DATE:** 12 JULY 2015
- **Venue:** OLYMPIYSKI MOSCOW
- **TIME:** 14H 00 – 17 H 00

ATTENDANCE REGISTER

Present:

PIETRUSZKA Frederic – FIE General Secretary

POZDNYAKOV Stanislav – Executive Committee Member, Executive Committee Representative/ Coaches

KULCSAR Krisztian - Sport Director FIE

JIE AO - Deputy Sport Director FIE

MURDACA Elena - Sport Administrative Manager and Secretary General PA

KORFANTY Edward – USA

TYSHLER Gennady – RSA

ZIDARU Octavian-Petru – ROU

PAVLOVITCH Vladislav – RUS

BOIDIN Franck – FRA

CIPRESSA Andrea – ITA

Apologies:

SAUCEDO Guillermo Jorge – ARG

OUEDRAOGO Julien – BUR

SZEPESI Laszlo – HUN

WANG Haibin – CHN

- **DATE: 30 JULY – 1 AUGUST 2015**
- **Venue: HOTEL CROWNE PLAZA, BUCHAREST**

ATTENDANCE REGISTER

Present:

TYSHLER Gennady – RSA

ZIDARU Octavian-Petru – ROU

SAUCEDO Guillermo Jorge – ARG

OUEDRAOGO Julien – BUR

Apolgies:

SZEPESI Laszlo – HUN

WANG Haibin – CHN

KORFANTY Edward – USA

PAVLOVITCH Vladislav – RUS

BOIDIN Franck – FRA

CIPRESSA Andrea – ITA

POZDNYAKOV Stanislav – Executive Committee Member, Executive Committee Representative/ Coaches

1. WELCOME

The President of Coaching Council welcomes everybody at the FIE Coaches Council meeting. The agenda for the meeting was circulated. G. Tyshler gave short report on the year of work of the coaching council and informed the council that he have invited to the meeting members of the FIE refereeing committee available. Unfortunately, no refereeing committee members are present. Materials from Coaching Council are now available at the FIE web site.

1.2 MINUTES

The minutes of the previous council meeting were circulated and approved via email.

2. PROPOSALS FOR THE 2015 CONGRESS

PROPOSALS FOR THE 2015 CONGRESS WITH COACHING COUNCIL COMMENTS DOCUMENT ATTACHED.

SPECIAL COMMENTS

- Coaching council in general positively looking at “Reintroducing the fleche for the sabre”, but this proposal must be tested to prepare correct wording in the rules to avoid “running on the piste” instead of executing the classical “ fleche attack”.
 - “At foil it is forbidden, during the course of fencing, to advance the shoulder of the non-sword arm in front of the shoulder of the sword-arm (cf.t.19). Any hits scored by the fencer at fault while committing this offence will annulled.” In this case, Coaching Council will ask referees to look closely at fencing phrases in close quarters, especially at the situations when fencers using “corps a corps” to avoid being hit with correct repost.
-

3. Discussions:

- The longest discussion was about the changing the blocking time in sabre. Practically all participants of the meeting took part in discussion. Two opinions were represented. One is to leave 120 mil blocking time in place. That will have the sabre refereeing simpler and less mistakes from the refereeing. Second is to change to 170 mil blocking time to have more valid ripostes and have sabre closer to original classical conventional weapon. Finally the vote was taken in favour for changing to 170 mil
4. Points for discussion with refereeing committee.
- Interpretation and application of: “attack “, “preparation”, “attack on a preparation” in sabre and foil. Video examples on the FIE web site.
 - Separate independent 3 video referees for the semi-finals and finals or possibly for all DE bouts. Joint discussion with SEMI committee.
 - The FIE referees list for the season. The referees in the list cannot attend any FIE competitions in capacity of Head of Delegation, coach or any other official position.
5. Joint meetings with Rules committee and Refereeing committee were conducted, few matters were discussed, no decisions were taken.

CONCLUSION

Dr. G. Tyshler thanked everybody for the work done. Draught of the minutes will be circulated by the president to all members for comments. The date for the next meeting will be announced.

Meeting closed.

01.08.2015

PROPOSALS SUBMITTED TO THE COACHES COUNCIL 2015 CONGRESS

MODIFICATIONS TO THE RULES Proposals of the Executive Committee

Proposal 1

Motivation: Update of the Publicity Code in line with standards that are closer to reality and harmonised with those of the IOC.

MARKS

p.9 Definition

The **mark** is the name or badge which identifies the origin, the manufacturer or the seller of a particular piece of the fencer's equipment.

As soon as the mark exceeds the normal or authorised dimensions, it becomes an **advertisement** and comes under the jurisdiction of the regulation below. (Cf. p.12)

p.10 Position and sizes

- 1 The articles of the fencers' **equipment** may carry the following visible marks:
 - a) **mask**: one mark on the rear of the spring. Maximum size: ~~6 x 5.5 cm~~ 12.5 cm².
 - b) **jacket**: one mark at the bottom of the jacket on the hip on the side of the non-sword arm. Maximum size: ~~4.5 x 2 cm~~ 30 cm².
 - c) ~~breeches~~ trousers: one mark at the bottom ~~of the breeches of the~~ trousers, on one side only. Maximum size: ~~4.5 x 2 cm~~ 30 cm².
 - d) **stockings socks**: one mark on each ~~stocking sock. in size 4.5 x 2 cm.~~ Maximum size: 10 cm².
 - e) **shoes**: the name of the brand on each shoe. Maximum size: ~~4.5 x 2 cm~~ 10 cm² or the usual logos (e.g.: bands).
 - f) **glove**: ~~no mark.~~ One mark: maximum size: 10 cm². If the mark is affixed on the glove with the help of a label (glued or sewn), the latter must be placed on the cuff.
 - g) **weapon**: ~~no mark visible at a distance. One mark.~~ Maximum size: 2.5 cm².
 - h) **electric jacket**: one mark at the bottom of the jacket on the hip of the side of the non-sword arm. Maximum size: 30 cm².

Application as follows: 1st of January 2016

IN FAVOUR

Proposal 2

Motivation: Allowing fencers to take advantage of potential sponsors.

p.12

2 Fencing clothing and equipment

- a) If a federation and/or a fencer have signed a **sponsorship contract** with a commercial or other company, the logo of that sponsorship partner, maximum 125 cm² in size, may be affixed at the top of the sleeve of the fencing jacket (non-sword arm), on the side of the trousers (left or right), or on the socks. At sabre, a logo may not be worn on the sleeve.

The sponsor(s) logo may be displayed on each side of the mask. Maximum size: 100 cm² on each side of the mask.

- b) The **number of logos** shall not exceed ~~four~~ five. The **total surface** of all logos added together may not exceed a total of 500 square centimetres.

Application as follows: 1st of January 2016

IN FAVOUR

Proposal 3

Motivation: The following is no longer part of common practice. Furthermore, it may provoke conflicts with the sponsors of athletes or federations. Therefore, the proposal is to remove the following articles from the Publicity Code:

~~p.12.5.b) As far as possible, the **organisers** must make it clear, in the conditions of entry for the competition, the way in which advertising material worn or carried by the fencers will be permitted.~~

~~LEG-BAND OR SELF-ADHESIVE NOTICE~~

~~p.13~~

~~1 Principles~~

- ~~a) The organisers of a competition may identify the fencers by issuing them with a number on a **leg-band** or on a **self-adhesive badge**.~~
- ~~b) In such a case, the wearing of this **band** or **badge** is obligatory for the fencers.~~
- ~~c) The **self-adhesive badge** must be of a rough material which will not cause the point to slip.~~
- ~~d) The **leg-band** or **self-adhesive badge** may have on it advertising material within the limitations of the rules below.~~

e) ~~The circular announcing the details of the competition must make clear what bands or badges the fencers are to wear, and what publicity will be on them. Entering the competition implies an acceptance by the fencer of the obligation to wear the band or badge in question.~~

~~2 Position and size~~

a) ~~The leg-band must be fixed to the thigh on the side of the non-sword arm. The maximum size of the leg-band is of 20 x 20 cm. The fencer's number must be at least 10 cm high and 15 cm in width.~~

b) ~~The self-adhesive badges must be fixed to both sides of the mask, on the side mesh.~~

~~The maximum size of the badges must be 10 cm wide by 15 cm high. The fencer's number must be no more than 8 cm high by 8 cm wide. At foil and épée only the self-adhesive badge of the competition taking place must be worn.~~

c) ~~In both cases, the advertising, words or badge, must be placed below the number and must not exceed 35 mm in height.~~

d) ~~If the self-adhesive badge on the mask does not include a number, it may only be used for advertising following agreement with the FIE.~~

Application as follows: 1st of January 2016

IN FAVOUR

Proposal 5

Motivation: Shorten the hours of competitions for the benefit of the athletes.

o.40

1 All the fencers qualifying from the round of pools are placed in a direct elimination table, complete or incomplete, according to the **indices resulting from the pools**. This table is fenced right through to the final.

2 For the juniors World Cup competitions, from the last 32 the **direct elimination bouts will take place on 4 pistes**, with each quarter of the table fenced on one piste.

For the cadets and juniors World Championships, from the last 32 the **direct elimination bouts will take place on 8 pistes**, with each quarter of the table fenced on 2 pistes.

IN FAVOUR

Proposal 7

Motivation: For the junior World Championships, increase the number of athletes in individual events to equal the one for entries to the junior's team events.

o.72

For the cadets World Championships, entries are limited to **three fencers per nation** for the individual events.

For the juniors World Championships, the entries are limited to **four fencers per nation** for each individual event, and **one team per nation** for the team events.

Application as follows: 1st of January 2016

IN FAVOUR

Proposal 11

Motivation: During tests performed in 2009, it was established that the adequate blocking time allowing for spectacular actions, such as the parry and the riposte, is situated between 160 and 180 milliseconds. It has been, therefore, proposed to change the current time to 170 milliseconds.

ANNEX B

CHARACTERISTICS OF EQUIPMENT

C) SABRE

a) Principles

1) to 7), no change.

8) After a hit has been registered, a subsequent hit made by the other fencer will only be registered if it occurs within a maximum of ~~420~~**170 milliseconds** (± 10 ms tolerance).

9) and 10), no change.

Application as follows: vote during the 2015 Congress and, if the change is adopted, application starting with the season 2016-2017.

IN FAVOUR

Proposal 12

Motivation: Reintroducing the fleche for the sabre, because it is a spectacular action and it should be allowed for this weapon, as long as it is perfectly explained to referees so that they don't equate it to another action.

t.75

5 - The step forward, ~~the fleche~~ and any forward movement in which the rear foot completely passes the front foot is forbidden. Any offence will be penalised as specified for penalties in the 1st group (cf. t.114, t.116 and t.120). Any hit scored by the fencer at fault will be annulled. However, any hit correctly executed by his opponent is valid.

Application as follows: vote during the 2015 Congress and, if the change is adopted, application starting with the season 2016-2017.

NOT IN FAVOUR

Coaching council in general positively looking at “Reintroducing the fleche for the sabre”, but this proposal must be tested to prepare correct wording in the rules to avoid “running on the piste” instead of executing the classical “ fleche attack”.

Proposal 13

It would be helpful for the fencing world to consider a new sensor for the sabre, using available technologies.

The old sensor was a mechanical sensor (physical contact).

A small steel ball was held by two springs in a small metal pipe. When the hit reached its target with sufficient force (500 g), the ball moved and closed the circuit.

Numerous problems were immediately identified:

- If the movement was perfectly linear, the ball did not touch the pipe and did not close the circuit.
- The 500 g varied depending on the springs used by the manufacturer and their age, therefore, there could be differences from one weapon to the other.
- The greater the tilt of the blade, the less the sensor worked.

With the new, inexpensive technology derived from the automotive industry, we are able to start considering the production of a new electronic sensor using MEMS.

The **MEMS (Microelectromechanical Systems)** technology is the technology of very small devices; we are talking of the nanometric scale of nanoelectromechanical systems (NEMS) and of nanotechnology.

Today, the MEMS are mainly used to detect movement inside mobile elements, for example, air bags, smartphones, GPS. In sports, they are used in tennis, golf, and baseball.

The final product will be a square with sides of approximately 25 mm and 4/6 mm thickness. It will include a battery, one or two MEMS, and electronic circuits for power supply and the MEMS. It will be easy to place in the sabre guard.

The project will have to involve a specialised company and/or a university laboratory as the 1st trial. The development phase of the software is long and complicated, as is always the case when developing low level software.

The SEMI Commission may coordinate the sports aspects of the project (specification of data to be collected, and trials on the piste).

STAGES OF THE PROJECT

- ▶ Measurement of loads, limitations, speed, and energy absorbed during typical real attacks, using adapted sabres. HD video recording of attacks. Data analysis. Determining the minimum force of the hit (500 g) and possible decisions to prevent hits in certain specific directions (for example, rectilinear, with only the button).

- ▶ Selection of suitable MEMS (1 or 2). Development of a prototype and verification of the utility of output data. Development of a software to control the MEMS. Creating a sample for the performance of limited tests (10/12 trials) on the piste. Correction of any software errors.

- ▶ Resistance test with the production of 200/250 samples to be given to one nation for a period of at least 6 months (preferably an entire season). Correction and improvement of final software.

IN FAVOUR

Proposals of the Refereeing Commission

The Referees Commission is proposing follow modifications:

Proposal 3

Technical Rules:

t.18.5. The order 'Halt!' is also given if the play of the competitors is **dangerous, confused**, or **contrary to the Rules**, if one of the competitors is **disarmed** or **steps off the piste**, or if, while retiring, he approaches too near the spectators or the Referee (cf. t.26, t.54.5 and t.73.4.j).

At foil it is forbidden, during the course of fencing, to advance the shoulder of the non-sword arm in front of the shoulder of the sword-arm (cf.t.19). Any hits scored by the fencer at fault while committing this offence will annulled.

IN FAVOUR

In this case, Coaching Council will ask referees to look closely at fencing phrases in close quarters, especially at the situations when fencers using "corps a corps" to avoid being hit with correct repost.

Proposal 4

t.120 cat 1: [Reversing the line of the shoulders.](#)

Reason:

- This modification would made more clear the decisions of the referee. It is mostly a "grey zone" and an interpretation whether the non-sword arm is covering the valid target.
- If the fencer is turning in the non-sword shoulder so in same time is not more visibly by the camera what he is doing with his non-sword hand.

For RC Claus Janka

IN FAVOUR

Deferred Proposals

1. Deferred proposal of the Hungarian Fencing Federation

Motivation:

It is merely a clarification of an existing rule, more precisely that the fencer must not be penalised by one meter unless he crosses the lateral boundaries of the piste with two feet.

t. 17.9

The return on guard, at a distance, for a **lateral exit of the two feet** may place the opponent committing the error on the other side of the rear line and lead to a hit.

Opinion of the working group 2015 (Rules, Refereeing, Promotion Commissions, Coaches Council, Athletes Commission) in charge of reviewing the proposal deferred in 2014:

The text proposed by the Rules Commission in English is preferable, but the English text will have to be adapted for application in French. The new French text proposed is the following:

If a fencer crosses the lateral boundaries of the piste, with one or two feet, he must be placed on guard at the correct distance, even if this means that he is placed behind the rear line and causes a hit to be awarded against him. (cf t.28, t.102).

IN FAVOUR

2. Deferred proposal of the Russian Fencing Federation

Motivation:

Reducing the number of simultaneous attacks for sabre. Increasing the number of actions in order to make matches more spectacular.

t.17.

1. For foil and épée, ~~the~~**The Referee places** each of the two competitors in such a way that the front foot of each is 2 metres from the centre line of the piste (that is, behind the 'on-guard' lines).

2. For sabre, the referee places each of the two competitors in such a way that the back foot of each is 2 m from the centre line of the piste (that is, in front of the "on-guard" lines).

Opinion of the working group 2015 (Rules, Refereeing, Promotion Commissions, Coaches Council, Athletes Commission) in charge of reviewing the proposal deferred in 2014:

The object of this proposal is to reduce simultaneous attacks at sabre. An ad hoc commission must be nominated by the Executive Committee as soon as possible, with the task to obtain statistics regarding simultaneous attacks during the rest of the 2015-16 season.

The working group is in favour of the proposal to organise tests, by introducing the rules proposed by the Russian Federation as temporary rules for all categories at sabre, men and women, during the period from the start of the 2016-2017 season until 31 December 2016.

The ad hoc commission will study the tests through comparisons with the statistics from the previous season. It will deliver its opinion at the end of 2016 to the Executive Committee, which will decide if the rule will be applied for the rest of the 2016-17 season.

The correct numbering of the articles in the proposal is t.17.2.a and t.17.2.b

IN FAVOUR

3. Deferred proposals of the Swedish Fencing Federation

Adjustment of calculation procedure for individual and teams world ranking during the year following the Olympic Games (o.83 and o.84)

Motivation:

Participation in the Olympic Games is very limited. However, the multiplying factor for points attributed during the Olympic Games is of 3 for the individual competition and 2 for the teams competition (World Cup: 1; Grand Prix: 1.5; and World Championships: 2). This leads to an imbalance in the world rankings during the year following the Olympic Games, which is not corrected prior to the next World Championship, which can have even more lasting consequences on the ranking.

Opinion of the working group 2015 (Rules, Refereeing, Promotion Commissions, Coaches Council, Athletes Commission) in charge of reviewing the proposal deferred in 2014:

The working group recognises that there is a problem with the official FIE rankings during the season following the Olympic Games. In particular, in all Olympic teams competition participation is very low, which gives too much protection to participating teams and causes immobility in the rankings during the season following the Games.

The intention of the proposal formulated by the Swedish Federation to find a solution to this problem has also been mentioned by the Athletes Commission. However, the Athletes

Council and the working group do not consider it appropriate to entirely cancel the results of the Games in the rankings of the new season.

The working group proposes that the multipliers be adjusted in order to reduce the consequences of the limited participation to the Games, and to improve the initial rankings of the competitions during the new season following the Olympic Games. The opinion of the working group is that the following multipliers are suitable:

The group proposes the following text in the Rules:

o.83.2 Individual ranking

b) The different competitions are attributed the following multipliers

Competition	Individual competitions
Olympic Games	2
World Championships	2
Grand Prix	1.5
Zonal Championships	1
World Cup	1

~~b) Points obtained in an individual A Grade World Cup competition have a multiplying factor of 1.~~

~~c) Points obtained in a Grand Prix competition of the FIE and a Zonal Championship are multiplied by a factor of 1.5.~~

~~d) Points obtained in the individual events of the Senior World Championships and in the Junior World Championships are multiplied by a factor of 2.5.~~

~~c) e) Points obtained in the individual events of the Olympic Games are multiplied by a factor of 3.0.~~ At the **Olympic Games**, the 4th is awarded ~~54~~ **36** points.

~~d) f)~~ Only fencers who have **actually participated** in a direct elimination table can receive any points.

IN FAVOUR

4. Deferred proposal of the Swedish Fencing Federation

o.84.2 Team scale of points

b) The different competitions are attributed the following multipliers

Competition	Multiplier
Olympic Games	1.5

World Championships	1.5
Zonal Championships	1
World Cup	1

b) For the World Team Championships, the points indicated above are multiplied by two.

c) Points obtained in a Zonal Team Championship have a factor of 1.0.

IN FAVOUR

5. Deferred proposal of the Swedish Fencing Federation

Creating a cycle for the Olympic programme, based on the principle of gender equality and equality between the different weapons (o.48.1)

Motivation:

The situation in which there are ten gold medals attributed to fencing at the Olympic Games continues since 2004, and there is no sign that the number of medals will increase. To this day, the Congress has taken decisions in what regards the Olympic programme three years in advance (for example, in November 2013 for the Olympic Games in Rio in 2016). It is clearly too late to allow athletes and national federations to prepare and plan their activities in a structured manner.

Consequently, it is desirable to clearly establish in our rules the Olympic programme cycle, in order to ensure stability and equity between the genders and the different weapons.

The Swedish Fencing Federation proposes the continuation of the cycle applied for the Olympic Games in Beijing, London, and Rio de Janeiro.

Opinion of the working group 2015 (Rules, Refereeing, Promotion Commissions, Coaches Council, Athletes Commission) in charge of reviewing the proposal deferred in 2014:

The working group is in favour of the proposal, but there seems to have been a misunderstanding concerning the structure of the proposed cycle. This proposal provides balance between the weapons and the genders in the current situation, even if it is very important to obtain two additional medals. The working group proposes the following cycle:

Programme of competitions

o.48

1. The programme of fencing events at the **Olympic Games** currently comprises 10 events. Given that the situation does not allow for organising 12 events, the programme of team events at the Olympic Games varies so that two weapons per team are not included during each Olympic year. For events not included in the Olympic programme, the FIE will organise World Championships.

The team competitions cycle at the Olympic Games will be:

Olympic Games 2016: Men's foil, men's épée, women's épée, women's sabre. (In the case of women's foil and men's sabre, the FIE will organise World Championships.)

Olympic Games 2020: Women's foil, men's épée, women's sabre, men's sabre. (In the case of men's foil and women's épée, the FIE will organise World Championships.)

Olympic Games 2024: Women's foil, men's foil, women's épée, men's sabre. (In the case of women's sabre and men's épée, the FIE will organise World Championships.)

The cycle described above is continued for the following Olympic Games (2028, 2032, ...)

Any change to the above cycle or to the number of events must be approved by the Congress.

IN FAVOUR

Women & Fencing Council Meeting – July 30-August 1, 2015

Hotel Crowne Plaza Bucharest, Romania

Present at the meeting: Helen Smith (HS), FIE Executive Committee – AUS; Stacey Johnson (SJ), Chair -USA; Shirly Drai-Last(SD) – ISR; Mayerling Lisbeth Rondon Gomez (MG) – VEN; Veena Devi Gunput (VG)– MRI; Katalin Tuschak (KT) – HUN; Maria-Leonor Estampador (ME) – PHI; Georgina Usher (GU) – GBR; Zhao Rong Loo (ZR) – SIN; Jian WU (WJ) – CHN

Apologies: Mervat Hassan Hassanein – EGY.

July 30, 11:15am – 1:30pm

(1) Introductions & Taking the Pulse from Members

The meeting went through the proposed agenda for the 3-day meeting. Introductions were made around the table for the benefit of Wu Jian who was new to the meeting.

Stacey updated the meeting with the proposed schedule for meeting with the other commissions.

Day 2 Inter-Commission Meeting Schedule

11:00 Meeting with Athletes Commission (only 1 athlete present here, Paris INOSTROZA)
14:30 Meeting with Medical Commission
15:00 Meeting with Referee Commission
15:30 Meeting with Veterans Council
16:00 Meeting with SEMI Commission
16:30 Meeting with Rules Commission
17:00 Meeting with P&P Commission

(4) Further Referee Seminars Discussion/Briefing On Pan-American Referee Seminar

SJ – updated all on the Women Referee Training held in San Jose, California, from June 26 to July 1. A number of participants were not well-prepared and this is a cause for concern as the purpose of such training is to develop competent high level referees. Participants should be practicing referees with good knowledge of the rules. They can also go online to search for refereeing resources to improve their knowledge of refereeing. FIE spent \$30,000 (3 hotel nights and airfare) and 11 licenses were awarded.

GU – reported that British Fencing is now investing and developing an online refereeing resource by getting video footages of competitions and tagging those with the right refereeing decisions to be put into various categories such as beat attack, etc. so that aspiring or existing referees can train themselves & improve their understanding by going online into the resource. Such a resource can help women referees to train themselves as well, though for now it would be open only to members of British Fencing.

SD – feels that a workshop will benefit participants in learning refereeing skills even if they do not pass the exams. Future training workshops could be combined with a platform for trainees to practice their skills refereeing at a competition like what was organized for the workshop in San Jose (many participants subsequently paid for the extension of their stay to

referee in the US Nationals). It would not always be necessary to include a refereeing examination with the workshop as the intention is to train the participants and not just to test.

Summary of discussion:

- We have to prepare women candidates for refereeing exams, by learning the Rules and watching videos.
- FIE has to improve the quality of teaching resources such as those that British Fencing are developing. The participants have to practice first.
- List of referees kept by FIE is outdated.
- Recommend that the next seminar be in Asia-Oceania. Keep it at 20 participants with the approach improved. E.g. 5-day seminar for training with a subsequent competition to practice the skills, then followed by the refereeing exam.
- SD – Stacey and Claus could send a letter to all countries to encourage the development of women as referees within federations.

MG – Propose that we set up refereeing schools – rather difficult. However, perhaps it's possible for the Coaching Masters schools set up by FIE (in Senegal and others in Asia & Pan-American) to also organize refereeing seminars twice a year.

(2) Updates On Key Action Items

Leadership Training Whitepaper

SJ – \$100,000 for 25 persons. No possibility of funding under Olympic Solidarity Foundation funding. Proposed training organization: Center for Creative Leadership (CCL) - an outstanding organization with deep roots within the U.S. Olympic Committee and the International Olympic Committee. IOC has not been conducting leadership training courses for some years.

HS – Continue to push for this initiative, but reword it? Maybe reduce to 15 participants, 3 from each zone?

KT – suggested that instead of presenting the total cost of the proposed course, instead present the cost per person to show that it the cost is not prohibitive.

SD – suggested that we include the cost of translation as not all participants may speak English.

Number 1 Proposal to promote: Increase Women's Participation in FIE Commissions to 30%
The meeting discussed strategies to have the proposal approved at the Congress

(3) Maximize Participation of Women in All Areas – Updates

HS & SJ will send out a joint letter to get support from all federations (to the President and Secretary-General) around November for the proposed increase of women's participation in FIE Commissions to 30%.

GU will also try to get a support letter from Claudia Bokel to increase support from federations for our proposal.

HS will contact Jochen Faeber to see if Thomas Bach would provide a letter of support.

Coaching – We have gathered a few names of female coaches who are good. SJ appealed to all to continue to give names of such coaches from their zone. They need not have coached senior national teams at World Championships, but must have credibility at the national level.

There are no females on the Coaches Council now. This should be remedied.
ME & ZR – To email the form from SJ to WJ to nominate some Chinese female coaches.

HS – briefed all on the CMI – Club Movement Initiative and suggested that the FIE should have some female coaches represented as well.

Technical – Technical qualifications are required for a position on the FIE SEMI Commission.

(8) Develop a Strong Communication Strategy – All Council Members

Asimina from the FIE Office is willing to help us with it.

GU and SJ have both hosted receptions in Kazan and New York respectively to promote the work of the WFC and provide a platform for women in fencing to network.

WJ will ask Chinese Fencing Association if they can host a reception at the Grand Prix in China or at the World Cup in Beijing to promote what the WFC is doing.

(5) Mass Participation Updates

HS – Laura Flessel went to the FIE COMEX meeting twice last year to present her proposal on Fencing Fitness but the President did not think the proposal was detailed enough. Proposal included fencing related exercises to music and use of plastic equipment.

SD – Fencing is a competitive sport and it seems strange to introduce fencing to the masses with exercises to music. However, plastic equipment is very helpful for promoting the sport as it involves less equipment and is safe. It is something that she uses in Israel in her work, introducing fencing for women over 35 years of age.

GU – Will share with the members what they have done in UK to promote fencing to the masses.

(6) Data Tracking Report

VG – Shared the report with all.

SJ – Voiced her concern about the small decrease in numbers for some FIE Junior events.

Disciplinary Panel – only has 10% members which is not in line with current FIE policy.

July 30, 2:30 – 5:30pm

(7) Review Proposals for 2015 FIE Congress & Action Plan In Preparation For The Congress

SJ presented the draft proposals and the meeting discussed how best to word the proposals and present them. Only Proposal 1 is for the 2015 Congress; the others are regarding the Council's ongoing work.

Proposal 1 (Nov 2015 Congress)

That the minimum representation of men and women on the FIE Executive Committee and all FIE Commissions and Councils should be raised from 20% to 30%.

Proposal 2

Continue to work with the FIE Refereeing Commission to organize female refereeing courses in each zone.

- *Continue the initiative to hold zonal referee training*
- *Host the next course in Asia/Oceania in September of 2016*
- *Continue the present format with improvements – 20 participants.*

Proposal 3

Work with FIE Sport Director to organize female coaching courses in each zone and ensure the inclusion of women in Club Movement Initiative.

Proposal 4

Identify and mentor future leaders in fencing through a leadership course aimed at

- *current and future female leaders, and*
- *male leaders of developing countries.*

Proposal 5

Work with the Legal Commission to develop a “Safe Sport” policy within the FIE that supports a culture of improving the development and safety of athletes and participants in the sport of fencing. (Although age is irrelevant to misconduct, emphasis must be given to creating a safe environment for those individual who are below the age of consent.)

The policy would work to inform and dissuade misconduct including but not limited to: Sexual misconduct, emotional misconduct, physical misconduct, and harassment.

The meeting also discussed ‘Safe Sport’ policies in each country. Most members shared that such policies did not exist in their countries.

GU shared that besides having a ‘Safe Sport’ policy, there are also Welfare Officers who are trained to look out for and safeguard the welfare of all members, particularly the young and vulnerable. Every sports club (not just fencing) is advised to have a Welfare Officer. They are trained to speak to people about such matters. Each of the GBR competitions will have a Designated Welfare Officer in attendance. The emphasis is on prevention. Materials related to the policy are also available for dissemination to members of the public.

July 31, 9:30am – 1:00pm

The meeting welcomed Asimina, FIE Media Manager, to the session. A round of introductions was made.

HS and SJ briefly updated Asimina on what the Council has been doing.

SJ shared the presentation on the 5 proposals with Asimina and HS further elaborated on Proposal 5 on Safe Sport.

The meeting also discussed the Women In Fencing Award drafted by ME. It was agreed that the proposal should suggest that the award would be given every two years.

SJ suggested and the meeting agreed that this award not be proposed during the November Congress, but would be proposed firstly to the COMEX for its feedback.

SJ informed all that she will not be attending the IOC Women's Conference this year and asked for interested participants. SD, GU and MG are willing to be considered.

Meetings with Various Parties

11:00 Meeting with Athletes Commission (Paris INOSTROZA)

The meeting started with a round of introductions of the various WFC members.

Shared all proposals with Paris who was receptive to them & made some helpful comments.

11:30 Meeting with Ben Paul from Leon Paul

GU presented the Behavioral Insight (UK Fencers 16-24) survey, a comprehensive study of 16-24 year olds across the UK. It was found that close to 50% of male fencers were in the Alternative category with half of them being gamers. A large percentage of female fencers were in the Leading Age category and were creative individuals. This study enabled British Fencing to better design strategies to promote fencing.

Ben demonstrated the new wireless mask as well as the new wireless fencing system which costs EUR999 for a complete set. It can be plugged into any conventional scoring machine to turn it into a wireless system as well.

Ben also presented Leon Paul's project to develop more comfortable chest protectors.

12:30 Meeting with Kristian Kulcsar (KK) and Nathalie Rodriguez (NR)

The meeting started with a round of introductions of the various WFC members for the benefit of KK.

SJ shared the 5 proposals with both and some useful feedback was given.

Proposal 2

SJ shared that the WFC suggests changing the format of future women's refereeing seminars to start with hands on practice first, then the test. But prior to that, participants must equip themselves with refereeing knowledge and practice first.

GU shared with both what BF is doing for the new online refereeing resource and self testing system.

NR - NFs should also use women referees more in their local competitions, so they can build up their confidence and get ready for international comps

July 31, 2:30pm – 5:30pm

14:30 Meeting with Medical Commission (Antonio FIORE, George RUIJSCH VAN DUGTEREN, Clare HALSTED, Maha MUSTAFA MOURAD)

The meeting started with a round of introductions of all members. Joined by some members of the **Rules Commission** (Manuel RONDON NIEVES, Rusni ABU HASSAN) as well as by Maria NTANOU, FIE Media Coordinator.

SJ shared Proposal 1 (which they support) and Proposal 5 which was also seen as being very important.

15:00 Meeting with Referee Commission (Claus JANKA, Marco SIESTO, Iana DAKOVA)

SJ presented Proposals 1 and 2.

Feedback :

MS – Election should be democratic with no quotas on male or female.

SJ – FIE should be a leader in sports and support IOC's stance towards 32% female participation in their commissions.

HS – Without a quota, it would be difficult to grow the percentage as there are countries who are more prone to nominating males.

ID – Better to have just purely a training seminar first to prepare the participants. Then those who are prepared can go for subsequent exam. Otherwise it does not reflect well on women if they pass female candidates who are not ready. Supportive of the 30% as a temporary measure to increase the % and hopes that in future, all 30% would be elected on their own merit.

CJ – Invited us to work with them on their new working group to improve structure of future refereeing seminars. SJ accepted the invitation & said the Council would be keen to work with the Refereeing Commission.

15:30 Meeting with Veterans Council (Francis KWONG, Max GEUTER, Ahmad AKBARIJAVID, Rita COMES, Gyorgyi FERDINANDY, Caryl OLIVER, Benoit PINCEMAILLE, Mark RAKITA) and joined by AO Jie

SJ presented Proposals 1, 4 and 5.

Bringing in the 80+ category to encourage those in the 70+ to continue to participate and not drop out.

Rebranding the Veterans competitions as Senior Plus competitions to attract more sponsorship.

16:00 Meeting with SEMI Commission (Semen RIKHTMAN, Daniel DE CHAINE)

Dropped by to show support for Proposal 1.

17:00 Meeting with P&P Commission (Cecile FAYE, Donald ANTHONY, Ali BELHAJ, Carl BORACK, Elena GRISHINA, Reno MAROLT, Nikolay MATEEV, Rigoberto MOREJON LLANES, Gianandrea NICOLAI)

The meeting started with a round of introduction of all members and SJ proceeded to share our proposals, with GU ending the meeting with the Behavioral Insight survey.

The P&P Commission members were supportive of our proposals.

August 1, 9:30am – 1:00pm

9:30am Meeting with Manuel RONDON NIEVES from Rules Commission & Vice President of the Pan-American Fencing Confederation.

Mr. Rondon Nieves believes the Pan-American Fencing Confederation will be agreeable to supporting the 30% female participation, but it is better to send an official communication to all Pan American countries to seek formal support for it. Central America, Pan-American and the Caribbean organizations are waiting for this official communication.

Since Mayerling brought up this issue 1.5yrs ago, he had been, by virtue of his VP position in the confederation, promoting the idea .and believes it should include DTs, referees, coaches as well as leaders.

There is to be a new school established in Pan-American for training of fencing coaches, referees. He believes that at least 50% should be women.

The letter needs to be received before the 15 August elections in Pan-American Confederation so that he and Mayerling can present it at the meeting.

SJ – Conveyed gratitude for Mayerling's strong support and the important work she has done in regard to this aspect. He will have the official communication from SJ and HS before 15 August. It will be sent to Mayerling and also to FIE for dissemination to all PanAm countries.

In the last session of the meeting, the proposals were refined by the Council as shown below. Refer to the presentation file for the rationale.

Proposal 1

November 2015 Congress

That the minimum representation of men and women on the FIE Executive Committee and all FIE Commissions and Councils should be raised from 20% to 30%.

Proposal 2

Continue to work with the FIE Refereeing Commission to organize female refereeing courses in each zone.

- *Women & Fencing Council to join Refereeing Commission Working Group to improve the training and testing process for all referees worldwide*
- *Work with Refereeing Commission to improve preparation of women before testing*
- *Continue the initiative to hold zonal referee training*
- *Host the next course in Asia/Oceania in September of 2016*

Proposal 3

Work with FIE Sport Director to organize female coaching courses in each zone and ensure the inclusion of women in Club Movement Initiative.

Provide FIE Sport Director a comprehensive list by national federation of existing female coaches.

Proposal 4

Identify and mentor future leaders in fencing through a leadership course aimed at

- *current and future female leaders, and*
- *male leaders of developing countries*

Proposal 5

Work with the Legal Commission to develop a 'Safe Sport' policy. 'Safe Sport' is a policy that aims to improve the welfare and safety of all athletes and participants in fencing. It works to dissuade misconduct.

Misconduct includes but is not limited to:

Sexual misconduct, emotional misconduct, physical misconduct, and harassment.



Women & Fencing Council

5 Proposals

FIE Statutes

6A.1 Women and Fencing Council

This council is appointed by the Executive Committee and performs the following functions:

- ▶ Increase the number of initiatives to encourage more women to participate in fencing, both as fencers and in the management of the sport
- ▶ Encourage the organisation of training courses for women in the different areas of sport (leadership, management, supervisory staff, coaching/training, refereeing...)
- ▶ Ensure equal opportunities in the management and participation of women and their representation in sport
- ▶ Encourage women to work and contribute to the development of fencing throughout the world at all levels.

Proposal 1

November 2015 Congress -

That the minimum representation of men and women on the FIE Executive Committee and all FIE Commissions and Councils should be raised from 20% to 30%.

Rationale:

- ▶ IOC President Thomas Bach has increased the number of women elected to all commissions by 49% in his first two years and the percentage of women on commissions to 32%.
- ▶ Women are now approximately 45% in terms of competitive fencing participation.
- ▶ Imperative to move our governance processes towards modernity and universality.
- ▶ Continue to demonstrate leadership in the world of sport by supporting women's progress in governance.

Proposal 2

Continue to work with the FIE Refereeing Commission to organize female refereeing courses in each zone.

- ▶ *Women & Fencing Council member to join the Refereeing Commission Working Group to improve the training and testing process for all referees world wide.*
- ▶ *Work with Refereeing Commission to improve preparation of women before testing.*
- ▶ *Continue the initiative to hold zonal referee training.*
- ▶ *Host the next course in Asia/Oceania in September of 2016.*

Rationale:

- ▶ Increase the number of female referees officiating in FIE competitions

Proposal 3

Work with FIE Sport Director to organize female coaching courses in each zone and ensure the inclusion of women in the Club Movement Initiative.

Provide FIE Sport Director a comprehensive list by national federation of existing female coaches.

Rationale:

- ▶ Increase the number of female coaches in order to increase the number of girls and women participating in fencing.

Proposal 4

Identify and mentor future leaders in fencing through a leadership course aimed at

- *current and future female leaders, and*
- *male leaders of developing countries.*

Rationale:

- ▶ Increase the knowledge, skills and confidence of current and future leaders thereby helping them to work successfully for the sport into the future.
- ▶ Support and encourage athletes into leadership positions.
- ▶ Create a legacy of strong leadership for the future of the FIE.

Proposal 5

Develop an FIE 'Safe Sport' policy with the Legal Commission. 'Safe Sport' is a policy that aims to improve the welfare and safety of all athletes and participants in fencing.

It works to dissuade misconduct.

Misconduct includes but is not limited to:

Sexual misconduct, emotional misconduct, physical misconduct, and harassment.

Rationale:

All forms of misconduct are intolerable and in direct conflict with the Olympic ideals.

On-Site Agenda FIE Veterans Council Meeting

Date: 30 July - 1 August 2015 Bucharest, Romania

Time: 0930 - 1730

Meeting venue: Hotel Crowne Plaza Bucuresti

	Agenda	Who (Lead for discussion)
1	Welcome	Max
2	Review of last meeting's minutes Challenges faced in the past year Confirm Agenda	All
3	Zonal Veteran Championships and regional activities update: Suggest-presenters.... Rita – USA/America Europe – David/Caryl/Gyorgyi/Benoit/ Marja-Liisa, Mark/Russia Ahmad/Middle East Francis/Caryl – Asia Pacific	All
4	Creation of 1st Asian Masters (Veteran) Fencing Championships in August 2015 in Manila	Francis
5	Propose of new age category for World Championships	Gyorgyi
6	Report and analysis of Debrecan World Veteran Championships survey data	Benoit
7	Update on 2015 World Championship @ Limoges (Timeline of website/info/registration etc)	Benoit/Max
8	Cooperation with Rules Commissions on Veteran relates rules change and update – join discussion with Rules for clarification and final amendment	14:30
9	Discussion and clarification with Women and Fencing Council on their 2015 proposal for FIE Congress	15:30
9b	Promotion & Publicity Commission	16:00
9c	Medical Commission	16:30
10	Outstanding issues: a. Veteran name change/modernize? (The name need to match proposed new logo “Veteran”) b. Outreach Program? c. Website	Rita/Caryl
11	Update on Veterans World Championships 2016 Stralsund (GER) (Timeline of website/info/registration etc) and beyond	Max
12	News from FIE Endowment Fund	Max
13	Proposal and Report for FIE	All
14	Any Other Business	All

FIE Veterans Council

30 July – 1 August 2015

Present:

Francis Kwong
Ahmad Akbari Javid
Marja-Liisa Someroja
Rita Comes
Mark Rakita
Gyorgyi Ferdinandy
Benoit Pincemaille
David Sweeney
Caryl Oliver
Max Geuter

Record of decisions

Minutes of the meeting 4-6 July, 2014 were agreed.

Agenda reviewed and agreed.

1. Zone Updates:

All zones reported growth of Veteran Fencing in their region. It was agreed that all events in all Zones operate within the FIE rules and formats so that relative results are comparable around the World.

It was agreed that a request be made to allow FIE referees up to the age of 65 to officiate at official Veteran Events.

Action:

Formally request to FIE to raise the maximum age of referees to 65 for Official Veteran Events

It was agreed that all Zones should actively seek to encourage Federations to offer themselves to host Veteran World Championships.

Action:

All members to contribute to materials designed to assist candidate bidding for Events

2. New Name

After considerable discussion it was agreed that Veterans should be known as Senior*Plus* for the future. This name to be gradually circulated in order to obtain feedback from stakeholders and supporters.

The proposed logo to be:



3. New Age Categories

80+ Age Group:

Evidence was presented to suggest that fencers in their late 70s are leaving the Sport because they do not believe they can compete with those in their early 70s.

It was agreed to propose a new category of 80+ understanding that numbers may be small to start with. This category could be run as a test event at the 2016 Veteran World Championships with a view to seeking inclusion of 80+ as a formal category.

Categories may therefore be:

A – 50-59

B – 60-69

C – 70-79

D – 80+

For Team Events, Category C may include fencers from Category C or D.

Action:
Test Events at 2016 Veteran World Championships – subject to organisers agreement.
Request to FIE to formally adopt 80+ category from 2017 Season.

4. 40-49 Age Category

Inclusion of the 40-49 Age Category was discussed. It was agreed that there were significant logistical implications associated with increasing the size of Official Veteran Events with this age category – up to 300 extra fencers (current size 650 fencers). It was also agreed that while there is demand from fencers to be included in the Veterans Events as early as possible it was not a priority in the same way as maintaining engagement of older fencers.

Action:
Research to be undertaken to better understand the impacts on events by the inclusion of this category.

5. Debrecen report

Benoit Pincemaille provided an analysis of participation at Debrecen.

- 18 Events.
- 638 Fencers
- 44 Nations

The full PowerPoint with all figures is appended to this document.

It was agreed that the layout of the venue, the format of the competition, weapon control, information and streaming services provided for this event were of the highest quality – confirmed by feedback from fencers. These provide a baseline for future World Championships.

6. Feedback from Questionnaire:

Feedback was collected from participants at Debrecen and collated. This document was discussed and actions arising from it were highlighted.

This document is appended to these minutes.

7. Limoges Preview:

Benoit Pincemaille presented floor plans and updates on the organisation for Limoges World Championships.

The PowerPoint with the details of this presentation is appended to this report.

It was agreed that results reporting was a priority and should be immediately available on the website.

There were a number of operational issues to be clarified for this event:

- Access to appropriate data for ranking purposes
- Sufficient medals for all team members
- Process by which order of bouts is decided in team events

It was also agreed that Council Members be featured as supporting this event.

8. Website:

A set of headings for inclusion on the Website was agreed. It was agreed that Caryl Oliver would expand this list and circulate to members before submitting it to FIE.

It was also agreed that all members would assist with providing content once the scope of the site was finalised.

Action:
Caryl Oliver to circulate proposed site architecture to Council and then submit to FIE

9. Rules Commission Proposals

The proposals from the Rules Commission were discussed extensively and amendments presented to the Rules Commission. With some minor differences of view both Commissions were in agreement with the changes and a revised document was finalised and returned to the Rules Commission.

Rules Commission responded positively to new name and logo.

This document is appended to these minutes.

10. Women and Fencing

It was agreed to support the Women and Fencing proposal for 30% representation of women on all commissions, committees and councils.

There was a valuable exchange of views on working priorities with the Women and Fencing Council.

It was agreed that members of both Councils would support our respective activities. The Women's Council responded positively to the new name of Senior Plus

11. Promotions

The Promotions Commission advised that their priorities lay with the lead up to Rio and activity associated with this.

The Commission shared a list of suggested categories of companies that may be approached for sponsorship of Veteran Fencing.

There was ambivalent response to new name and logo.

12. Medical

Useful discussion about health implications with older people taking up fencing. Medical Commission have agreed to provide material to assist those encouraging older fencers and potential content for website. There was also discussion about anti-doping and gender issues that assisted this Council with their understanding.

An article on Veteran Fencing for Escrime Magazine was offered by Peter Harmer and accepted.

Members of the Council alerted to advise their zones of the need to provide evidence of medication prescribed that may be on the banned list.

The Commission responded positively to new name and logo.

13. Stralsund Preview

Max Geuter presented preliminary information about the venue for 2016 Veteran World Championships. 10-16 October, 2016

It was agreed that there was ample space and association accommodation and further details to be welcomed at the next meeting.

14. Maribor Preview

Dates: 16-21 October 2017. No further information at this stage.

15. 2018 Preview

USA suggested but subject to further discussion.

16. Endowment Fund Update

Max Geuter updated the meeting on the current activity of the Fund.

It was agreed that while the Fund priority lay with solely supporting ex-fencers there was no role for this Council.

This Council is keen to assist in working with this fund to increase the depth and spread of Veteran Fencing and hopes that the parameters of this fund may be expanded in the near future.

17. Upgrade to Commission

There was discussion about this group being designated as a Council. It was agreed that this group seek to have its designation changed to a Commission.

Action:
Formally request to FIE to designate Veterans Council as a Commission

PROPOSALS SUBMITTED TO THE VETERANS COUNCIL 2015 CONGRESS

MODIFICATIONS TO THE RULES Proposals from the Veterans Council to the Executive Committee

Proposal 1

o.87

1. The organisers must submit the programme of events to the Executive Committee for its approval.
2. The programme must be arranged in such a way to allow any fencer to participate to all weapons. Team events must be held on the day following the last championship of the three categories of each weapon.
3. No changes of days are allowed for each competition, after the release of the programme.
4. Each competition must be held in one single day, avoiding long inactive time along the progress of it.

Proposal 2

o.88 Entries for competitions

1. Entries must be sent to the organisers by the competitors' national federation. Entries shall be sent not later than one month before the beginning of the championships.
2. However, until two days before the competition at noon (local time), fencers may be added by their national federation after payment to the Organizing Committee of a penalty equal to 100% of the registration fee.
3. Entries for team championships must be forwarded to the Directoire Technique not later than 4.00 pm (local time) of the day before the competition.

Proposal 3

o.89

At the Veterans World Championships, entries for the individual events are limited to four fencers in each category per gender, per weapon and per nation. The names must be consistent with FIE licences.

Proposal 4

o.90 Composition of the pools for individual championships

When drawing the pools, the Directoire Technique will take into account the following orders of strength:

1. The 64 highest ranked from the addition of the results in the two last years Championships, irrespective of age category changes;

2. All other fencers in order of age, starting from the youngest.
3. The allocation of fencers in the pools must be made in such a way as to place fencers of the same nationality, as far as possible, in different pools, by moving them down the ranking as necessary.
4. If in any category there are fewer than ten competitors, the competition is held as a poule unique plus direct elimination.
5. If in any category there are fewer than 6 competitors, they will fence with the lower age category. A separate ranking for this category will be extrapolated from the combined categories final rankings at the end of the competition.
6. If in any category there is only one competitor, the event in that category is cancelled.
7. No fencer is eliminated after the poules, all enter into direct elimination.

o.91 Duration of the matches

The direct elimination bouts are for 10 hits or end when two periods of three minutes, with one minute rest between the periods, have passed. As an exception, at sabre, the first period ends either at the expiry of the three minutes or when one of the fencers has scored five hits.

Proposal 5

o.92. Team championships

1. Participation

Each country can enter one team per gender and per weapon, thus giving place to 6 competitions.

2. The rules for team championships are applicable with the following exceptions:

a) For each weapon, the teams are constituted by three fencers of the same nationality, one from category "A", one "B" and one "C" with or without one reserve for each category. A team cannot begin the match if it is not complete.

b) In the case of a team being short of a fencer in a weapon the team may use a fencer who has competed in the individual championships at another weapon, but his/her ranking will be deemed to be the last ranking at that weapon plus 1.

c) The teams are placed in the poules according to the ranking of the three fencers in the individual championship, the highest place for those having the lowest total. All the fencers registered for the team event must be present at the piste before the start of the match.

d) Each team may ask to substitute a fencer before the start of the bout, except in case of injury duly recognized by the Medical delegate, when the substitution can be immediate. There can be only one replacement per match.

3. The fencer who has been replaced because of an injury may not fence again during that match. If both a fencer and the reserve, if any, are forced to retire, or if a fencer is excluded, their team has lost the match.

4. The relay system is always applied. The three fencers of a team fence against the opponent of the same category. Each fencer fences twice his/her opponent for a total of 6 bouts. The bouts are for 5 hits (5-10-15-20- etc.); the maximum time for each bout is 3 minutes.

5. The team that first reaches the maximum score of 30 hits, or that which has scored the greatest number of hits after the expiry of regular time, is the winner.

6. The order of categories for each match is established by the referee with the captains on the piste prior to the match starting: The referee will “toss a coin” and the winning captain will select the first category in the order. The losing captain will select the second category.

8. The competition consists of a round of poules of 3 or 4 teams, in which all the teams participate, and a direct elimination phase for a maximum of 16 teams, the other teams will be classified according to their place after the round of poules.

9. If there are less than 6 teams, after an unique poule, a match for the 3rd and 4th places is held, then a match for the first place between the 1st and the 2nd.

Proposal 6

o.93 Referees

Refereeing Veteran World Championships is carried out by referees appointed by the Executive Committee of the FIE, selected by the Refereeing Commission on indication of the Organizing Committee. Fifteen of them shall be of at least eight different nationalities, being no more than two of each nationality; the other necessary referees shall be from the organizing country. In case of unavailability of sufficient national referees, they will be chosen by the Organizing Committee from nearby countries.

Referees' travel and board and lodging costs are paid by the organising committee who in return will receive all the entry fees, as stated in art. 6.2 of Administration Rules.

Referees must attend the refereeing meeting that takes place the day before the World Championships.

Proposal 7

o.94 Invitations for international officials

1. Any proposed candidature for organising the World Championships must be studied at the venue concerned by a delegate designated by the Executive Committee, at the invitation of the candidate federation.

2. The organising committee of the World Championships, who will receive all the entry fees from the participating delegations, must, at their own expense, invite the following international officials (tourist-class return air fare, accommodation and daily allowances):

a) The President of the FIE or his representative, who presides over the World Championships and, in particular, controls the smooth running of the Directoire Technique.

b) Four members of the Directoire Technique appointed by the Executive Committee of the FIE, one of whom must belong to the organising country.

c) One member of the SEMI Committee, appointed by the Executive Committee of the FIE.

d) One member of the Refereeing Committee, appointed by the Executive Committee of the FIE.

e) One member of the Medical Committee, appointed by the Executive Committee of the FIE.

These official shall be preferably be selected from the same Zone of the Championships.

Proposal 8

ADMINISTRATIVE RULES

6.2 Amounts to be paid to the organisers:

Subject	Euros
Individual entry fee Cadets, Juniors, Seniors, Veterans World Championships	55
Team entry fee Juniors, Seniors, Veterans World Championship	140
Referee fee Individual Veterans World championships	45
Referee fee Team Veterans World championships	45

Proposal 9

HANDBOOK OF REGULATIONS

1.2 DESIGNATION AND EXPENSES

The Organisation Committee will pay for the expenses of the President of the FIE or his representative (plane ticket in economy class, lodging and per diem), in accordance with article o.89 of the FIE Organisation Rules.

Officials

According to financial arrangements stipulated in Chapter 7 of the Administrative Rules of the FIE, the following officials are designated by the Executive Committee of the FIE and reimbursed by the organisers:

- four (4) members of the Directoire technique, including one from the host country;
- one (1) delegate of the Refereeing Commission;
- one (1) delegate of the SEMI Commission;
- one (1) delegate of the Medical Commission.

These official shall preferably be selected from the same Zone of the Championships.

Summary

- **Participation**
- **Running of the competition**
- **Focus on Team event**
- **Results of questionnaire**
- **Conclusion**

PARTICIPATION (Nations)

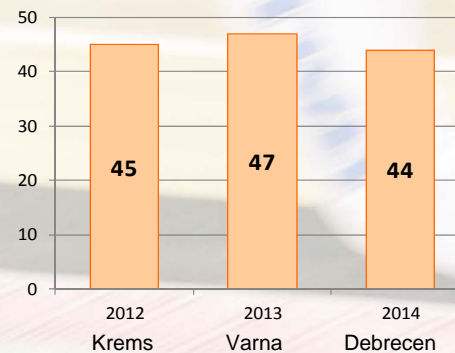
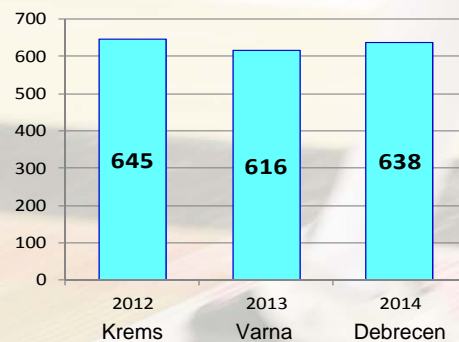
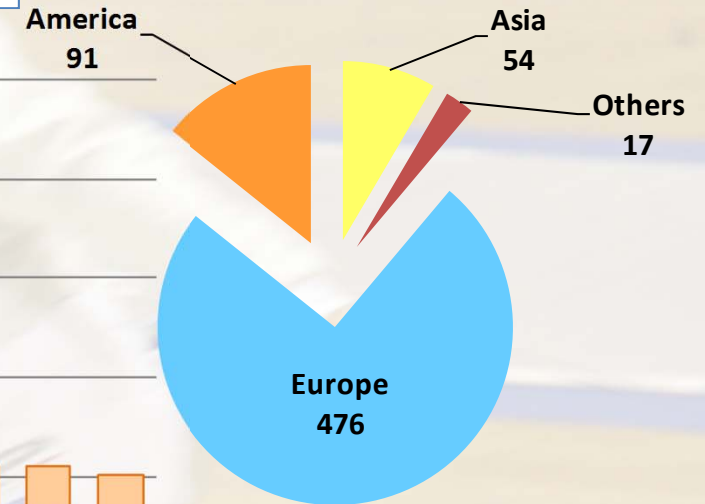
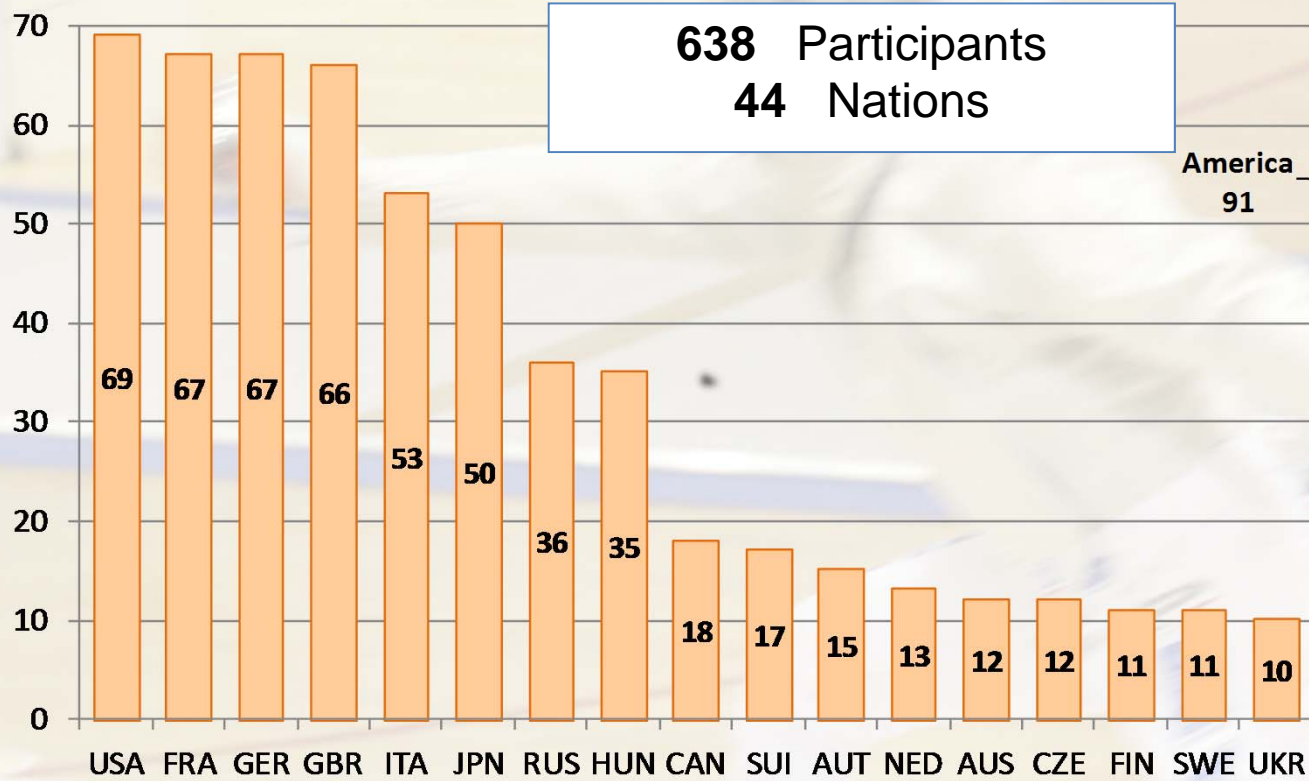

PARTICIPATION (Categories)

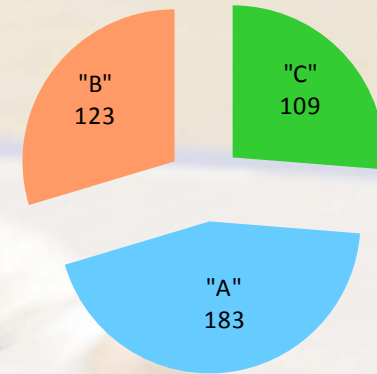
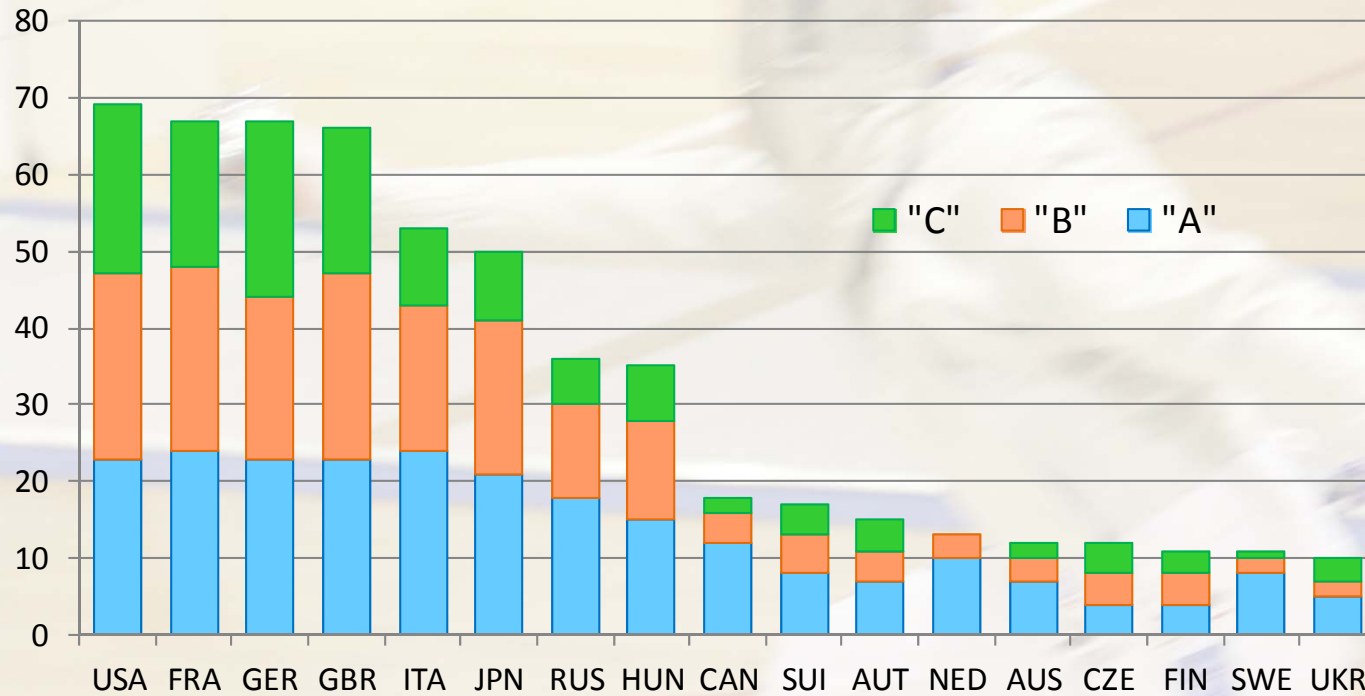

MEN (415)

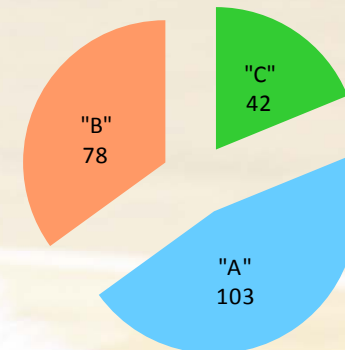
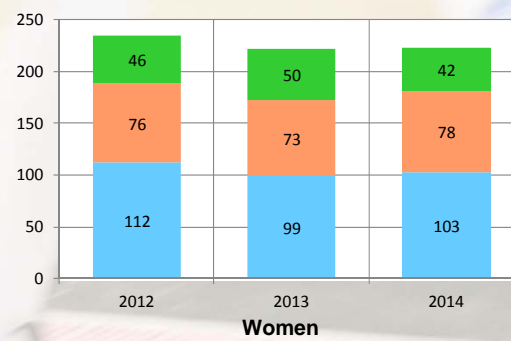
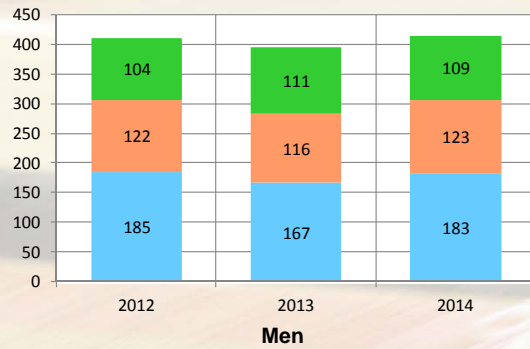

WOMEN (223)

PARTICIPATION (Weapons)

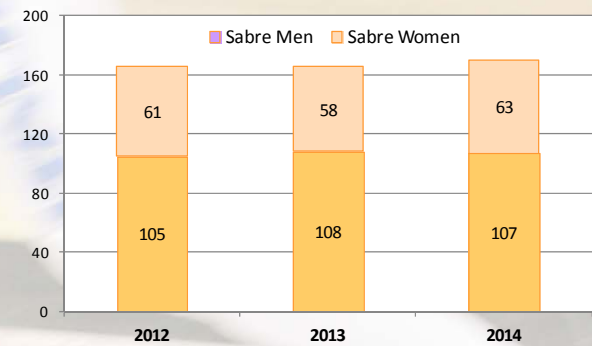
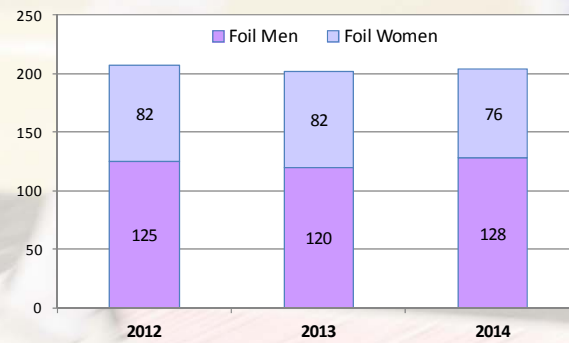
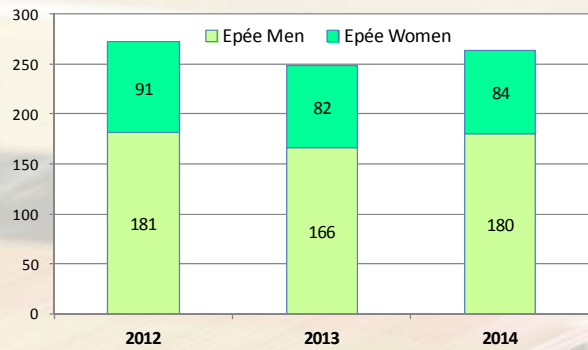
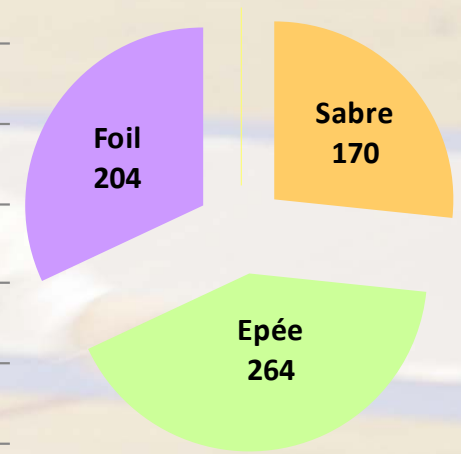
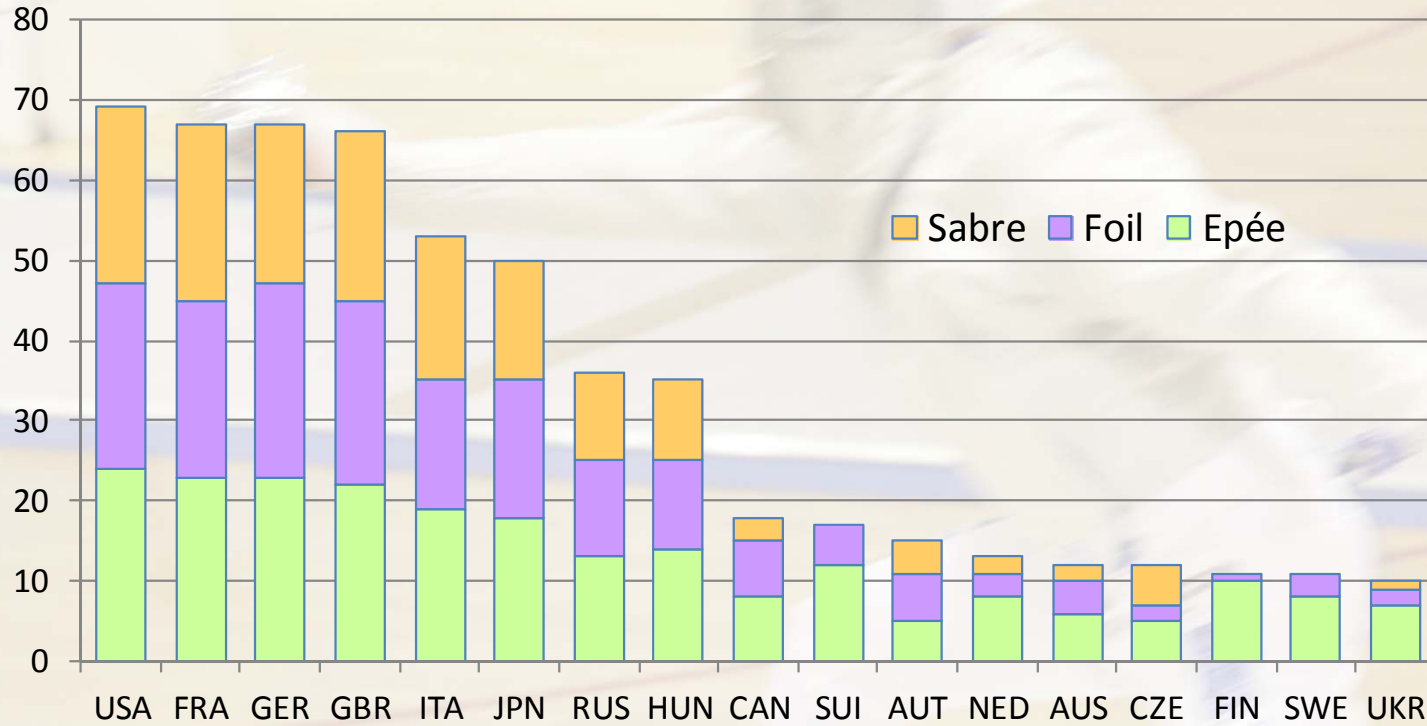

MULTIPLE PARTICIPATIONS

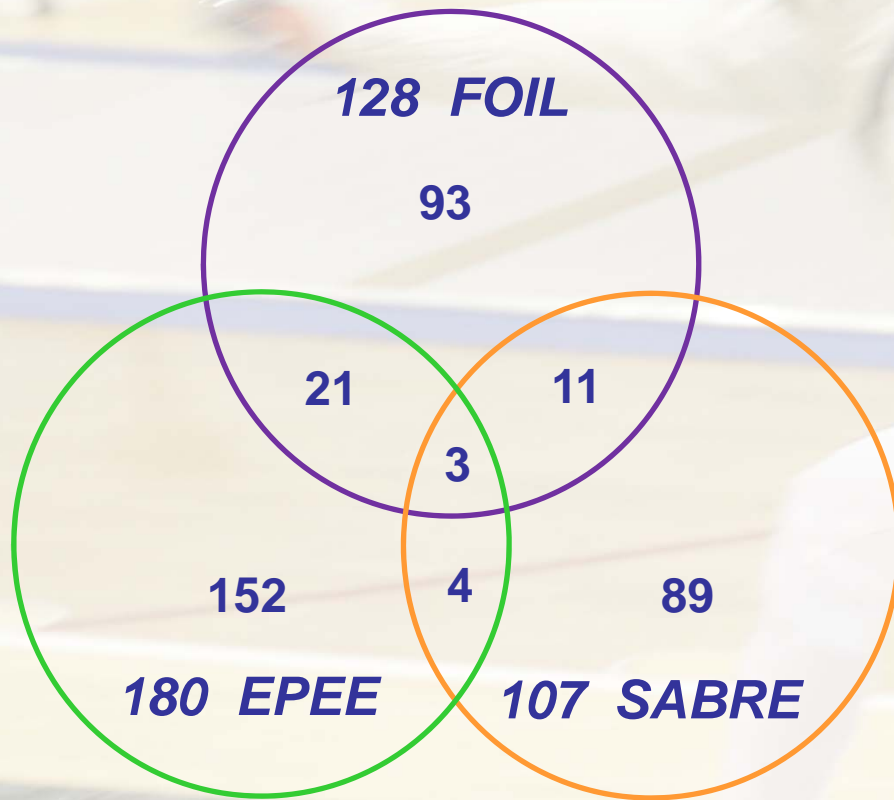

373 Fencers
Men : **415 Participants**

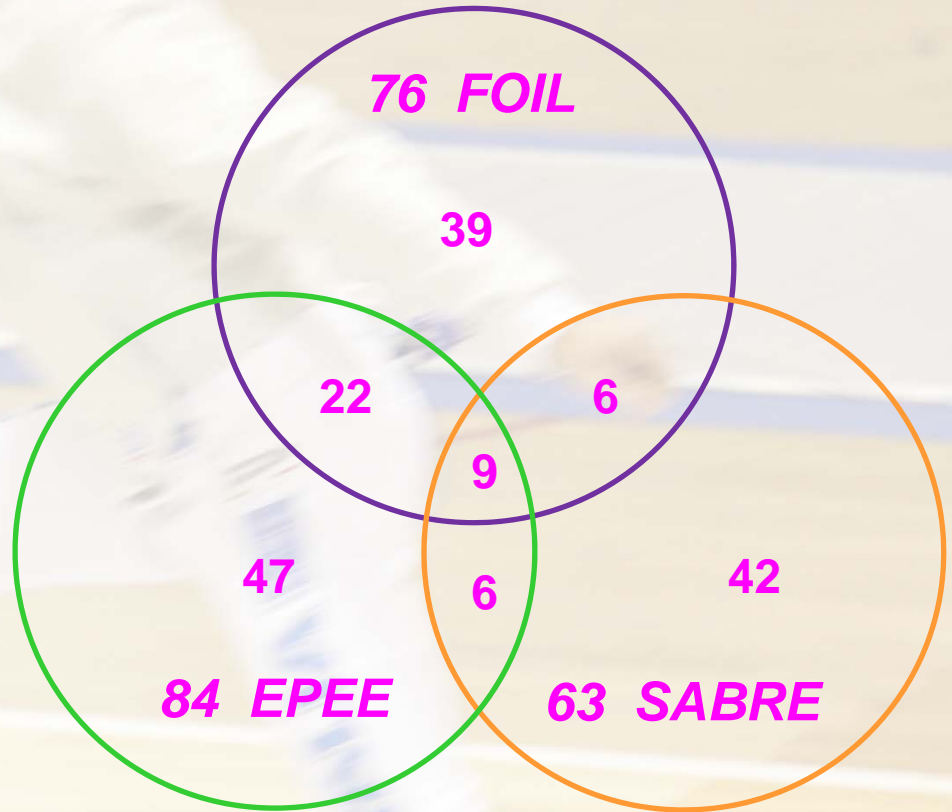

172 Fencers
Women : **223 Participants**

THE COMPETITION



Men Foil
Cat. B

World Veterans Fencing Championships 2014 Pool B Men Foil Semifinals	
Tableau of 16	Tableau of 8
3. HIROSHITA Kenichi JPN	10/8
14. TIBERI Francesco ITA	10/8
11. PRATER Ralph GER	10/7
6. YAMAZAKI Yusaku JPN	10/7
7. STREB Joseph USA	THOMASER Frank 10/7
10. THOMASER Frank USA	10/7
18. ZAKHROV Reviz RUS	LOWEN Paul 6/5
2. LOWEN Paul GBR	

PBT FENCING
www.pbt fencing.com

RANKING (for constitution of poules)

FOIL WOMEN "B" at DEBRECEN (2014) <i>born between 1945 and 1954</i>				FDA Krems (2012)	FDB Krems (2012)	FDA Varna (2013)	FDB Varna (2013)	TOTAL
46	SOMEROJA	Marja-Liisa	FIN	1	38		80	118
48	HALSTED	Clare	GBR	2	80		36	116
51	OFFERLE	Judith	USA	3	65		38	103
53	WESSEL	Ute	GER	4	30		65	95
54	WALTERS	Anne-Marie	USA	5	65	24		89
48	WILLARD	Antoinette	FRA	6	50		34	84
46	PALM	Kerstin	SWE	7	30		50	80
48	MAYOROVA	Liubov	RUS	8	50		30	80
47	MYERS	Margaret	GBR	9	34		26	60
48	GARDINI	Iris	ITA	10	28		32	60
54	AMARI	Kaoru	JPN	11	8	50		58
54	STARKS-FAULKNER	Jenette	USA	12	26	28		54

EPEE MEN "B" at DEBRECEN (2014) <i>born between 1945 and 1954</i>				Rank	EHA Krems (2012)	EHB Krems (2012)	EHA Varna (2013)	EHB Varna (2013)	TOTAL
50	FISCHER	Volker	GER	1		80		80	160
51	RINGEISSEN	Francois	FRA	2		50		65	115
47	IDE	Eiichi	JPN	3		65		38	103
53	IMREH	Laszlo	HUN	4	65			28	93
50	RYNES	Frantisek	CZE	5		34		22	56
52	MARINO	Giuseppe	ITA	6		22		34	56
50	MALAFOSSE	Patrick	FRA	7		50			50
51	PAP	Jeno	HUN	8				50	50
53	YAMAZAKI	Yutaka	JPN	9				50	50
47	PAUL	Graham	GBR	10		16		32	48
50	SYROVATKO	Stanislav	UKR	11		36		7,5	43,5
53	SOKOLOV	Viktor	UKR	12	30			13,5	43,5

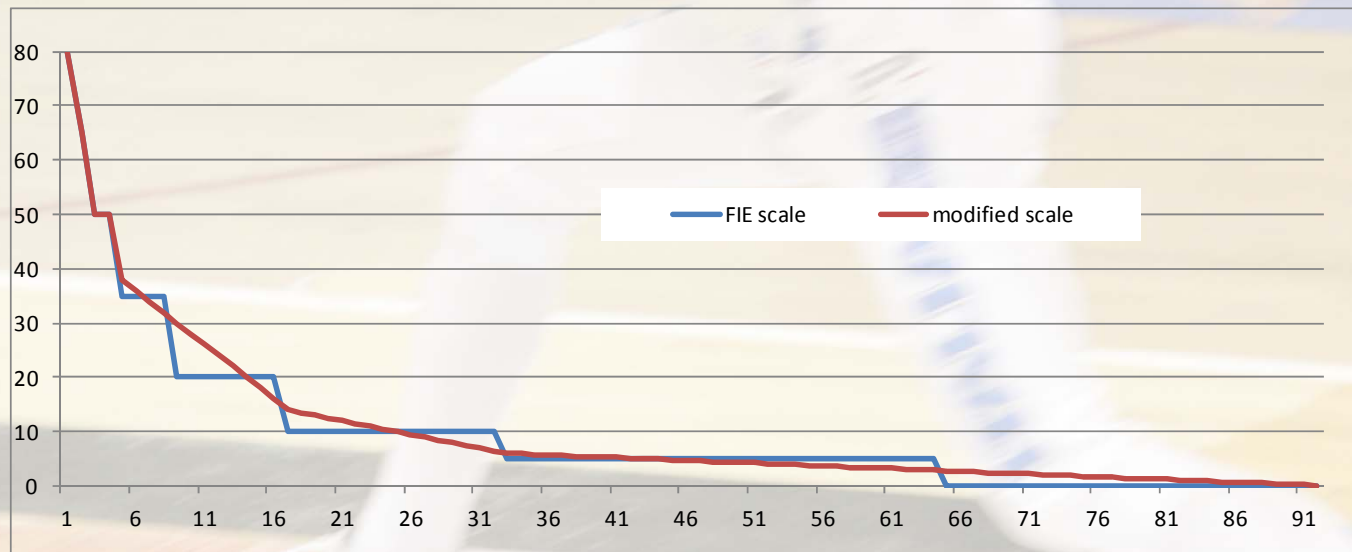

TIMETABLE

	Tuesday	Wednesday	Thursday	Friday	Saturday	Sunday
FOIL	38 B 36 C	58 A	9 TEAMS			
EPEE		8		53 B 44 C	83 A	13 TEAMS
SABRE		30 C	43 A 34 B	9 TEAMS		
FOIL		12	36 A	27 B 15 C	5 TEAMS	
EPEE	44 A	31 B 16 C	6 TEAMS			
SABRE			9		29 A 23 B 11 C	5 TEAMS

120 / 150 Competitors per day

17 Pistes 38 Referees

TEAM COMPETITION (Participation)

47 Teams
14 Nations

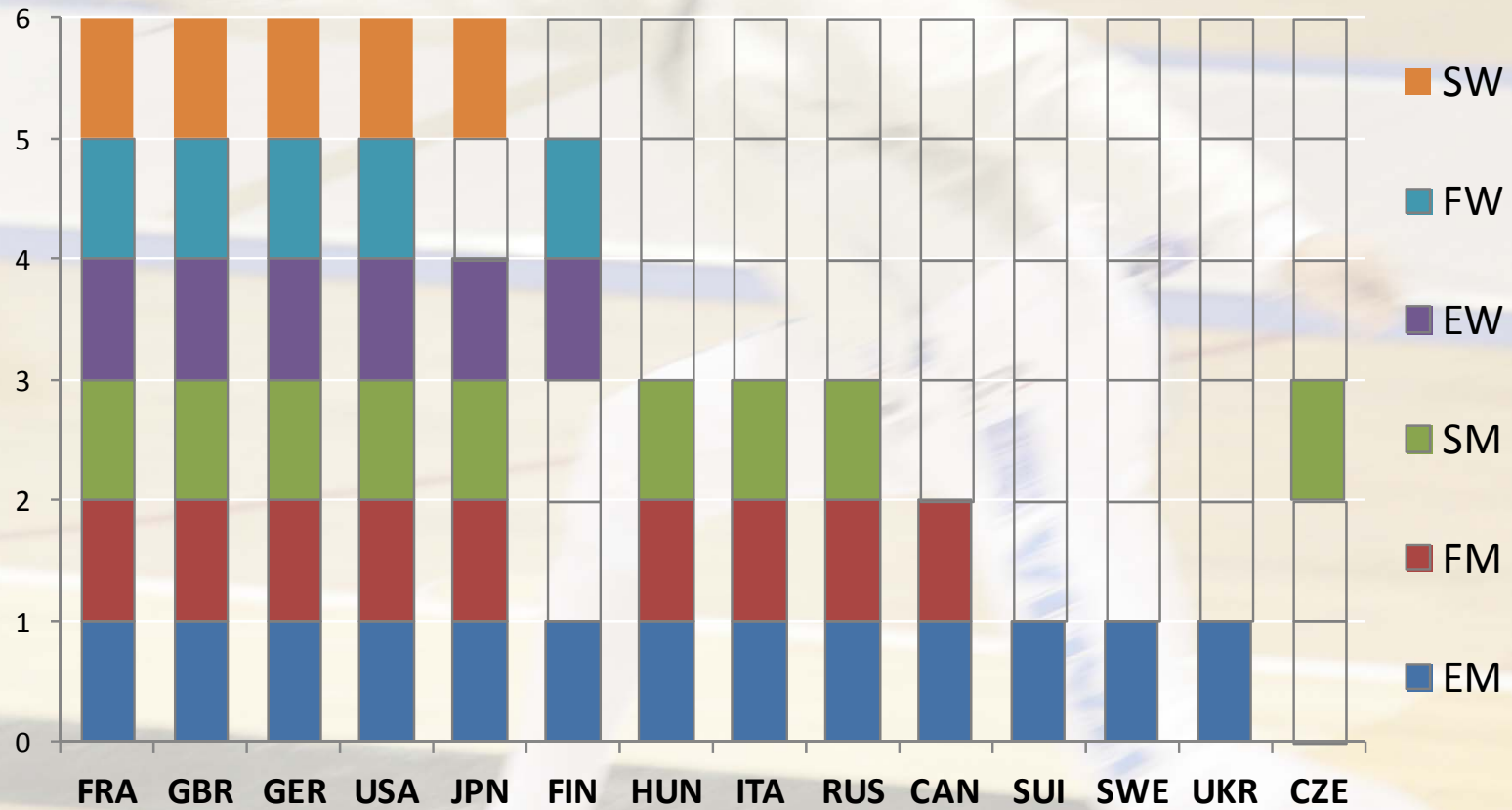

TEAM COMPETITION (Running)

WORLD VETERANS TEAM CHAMPIONSHIPS DEBRECEN 2014		
<input type="text" value="Nation"/>	<input type="text" value="Weapon and sex / Arme et sexe"/>	
CAT	Name/Nom	First Name / Prénom
A 50+	<input type="text"/>	<input type="text"/>
A 50+	<input type="text"/>	<input type="text"/>
B 60+	<input type="text"/>	<input type="text"/>
B 60+	<input type="text"/>	<input type="text"/>
C 70+	<input type="text"/>	<input type="text"/>
C 70+	<input type="text"/>	<input type="text"/>
PLEASE SUBMIT THE NAMES OF TEAM MEMBERS TO THE DT BEFORE 5 PM THE DAY BEFORE THE TEAM EVENT		
<input type="text" value="Head of delegation :
Chef de délégation :"/>		
<input type="text" value="Team Captain :
Chef d'équipe :"/>		

FOIL MEN			Best indiv. results		
Nation	Ranking	Tot.	A	B	C
HUN	1	13	3	3	7
GER	2	15	2	11	2
ITA	3	17	10	1	6
RUS	4	22	9	12	1
FRA	5	33	15	15	3
GBR	6	36	21	3	12
USA	7	42	5	20	17
JPN	8	48	19	5	24
CAN	9	76	26	31	19

EXAMPLE (Foil Men)									
GBR		Poule n°1						HUN	
Fencer	Cat.	Indiv. score	TEAM SCORE	TEAM SCORE	Indiv. score	Cat.	Fencer		
TROIANO	John	A	4	4	3	3	A	CSAK	Attila
LOWEN	Paul	B	6	10	9	6	B	PAP	Jeno
GREEN	Christopher	C	1	11	11	2	C	BOROS	Peter
TROIANO	John	A	1	12	13	2	A	CSAK	Attila
LOWEN	Paul	B	6	18	17	4	B	PAP	Jeno
GREEN	Christopher	C	6	24	30	13	C	SZENTKIRALYI	Istvan
Tot.			24	30					
Winner :			HUN						

MEDAL RESULTS

		<i>Individual</i>			
		GOLD	SILVER	BRONZE	Total
1	USA	3	4	6	13
2	ITA	4	1	0	5
3	GER	2	6	6	14
4	UKR	2			2
5	FRA	3		5	8
6	RUS	2		1	3
7	GBR	1	1	6	8
8	AUT	1			1
9	AUS		3		3
10	FIN		1	2	3
11	HUN		1	4	5
12	JPN		1	1	2
13	SUI			2	2
14=	GEO			1	1
14=	NED			1	1
14=	CAN			1	1
		18	18	36	72

<i>Teams</i>				
GOLD	SILVER	BRONZE	Total	Total
2			2	15
1		1	2	7
2	2	1	5	19
1			1	3
	1		1	9
	1	1	2	5
	1	2	3	11
				1
				3
	1	1	2	5
				5
				2
				2
				1
				1
				1
6	6	6	18	90

QUESTIONNAIRE (Results)

Website :	😊	😐	☹️
Did you access the competition website leading up to attending this event ?	72%	28%	0%
Was the information about the competition venue and timetable helpful?	67%	30%	3%
Was the information about travel and accommodation useful?	36%	54%	12%
Was there enough additional information to help you plan your visit?	38%	48%	14%

Team competition :	😊	😐	☹️
Were the rules of the Team Competition clear to you?	70%	21%	9%
Did you enjoy the team structure and relay system for this event?	81%	16%	3%
Did you think the poules and tableau system was effective?	94%	3%	3%
Did you feel that the event ran smoothly and to time ?	78%	16%	6%

General organisation :	😊	😐	☹️
Did you find the Weapon Control well organized and efficient?	83%	17%	0%
Did the competition timetable work for you?	67%	22%	11%
Was the communication throughout the event helpful and informative?	47%	41%	12%
Was the catering appropriate and sufficient for you?	14%	50%	36%

Anything else you would like to tell us?

QUESTIONNAIRE (Appreciations)

1) Positive appreciations :

- Wonderful venue and all pistes in the same place.
- Very good organisation.
- Global timetable quite relevant.
- Relay system for team competition much appreciated.
- Excellent weapon control.
- Refereeing outstanding.
- Effective real time display of results and streaming.
- Many volunteers, always smiling.
- Nice gala dinner.

2) Negative appreciations :

- Too many changes in the schedule, late communicated.
- Some down times should have been avoided.
- Free WiFi appreciated but sometimes too slow.
- Catering organisation not convenient.

QUESTIONNAIRE (Suggestions)

Propositions of competitors, heads of delegation and President of the DT (Henri Jansen) :

- To make registration under control of **FIE database** (to check names spelling and FIE licences).
- To make registrations up to **1 h.** before the beginning of the events (*then, no display the day before....*).
- To display, the day before, the time of the beginning of poules, of tableau, and notify that it will be a non-stop competition up to the 1/2 final.
- No eliminated after poules.
- To clarify the **substitution rules**, particularly in case of injury, for team competition.
- To examine the relevance/conditions of **participating at individual prior to team event**.
- To precise the rules of tableau constitution after the poules of team event.
- In case of **5 teams** : the poule unique should be followed by a final match and a bronze match.
- Call room should be necessary only for finals.
- To give to all heads of delegations an emergency dial number to call the DT.
- Two WiFi systems, one for staff and Press, the other for accompanying and athletes.
- More people at catering and more choice of eating .

A blurred photograph of a fencer in a white uniform performing a lunge on a fencing strip. The background is a light-colored wall with blue and red lines.

CONCLUSION

Three keys to success for next championships :

- **Competent staff**
- **Suitable venue**
- **Reasonable requests**

***Thank you and good bye Debrecen
We'll meet again in LIMOGES (France)***



WORLD VETERANS CHAMPIONSHIPS LIMOGES 2015

Summary

- **Tour of the premises**
- **Status of preparation**
- **Website**
- **FIE visit (September)**

LIMOGES 2015



THE VENUE

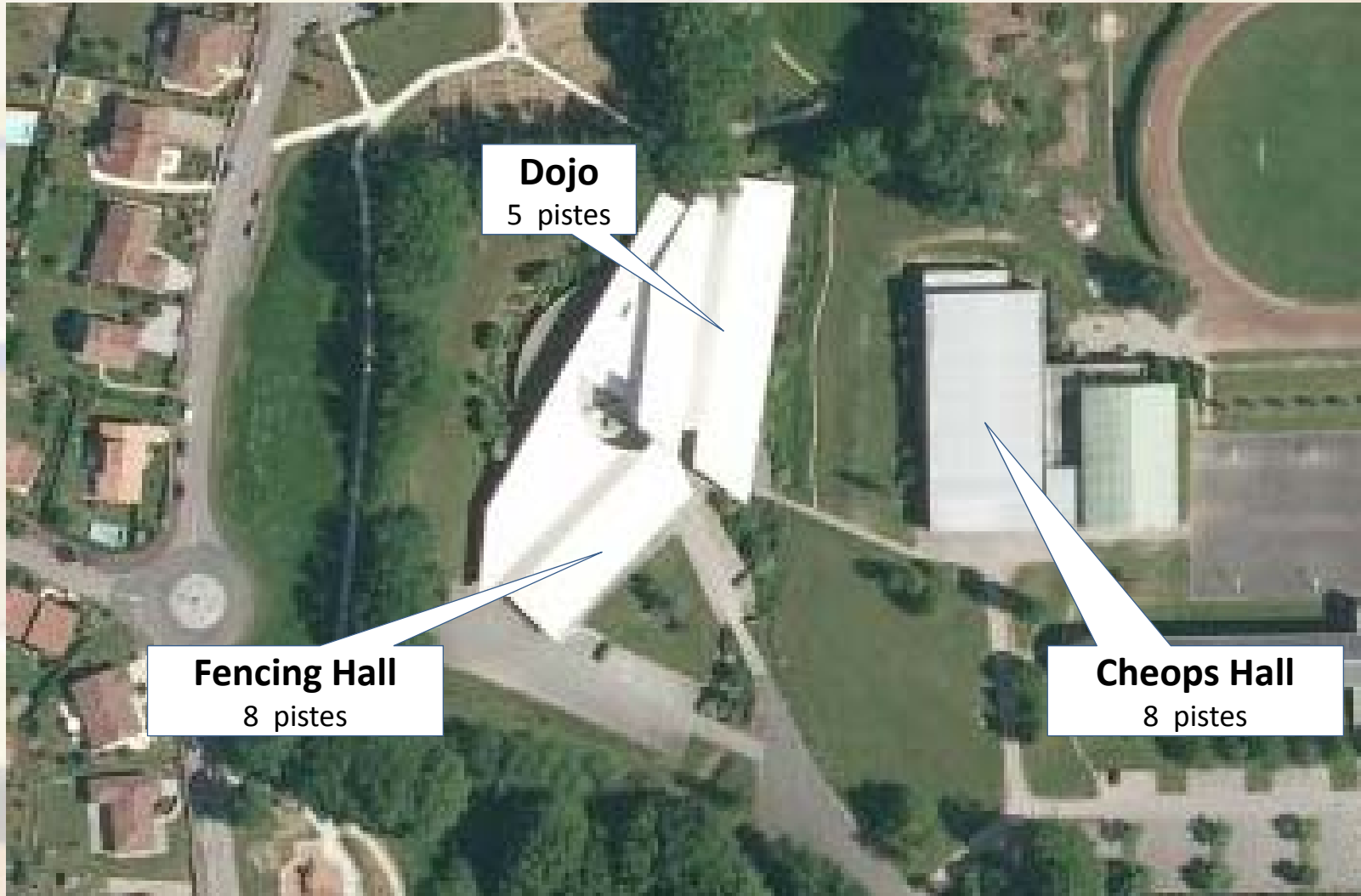

DOJO



DOJO



FENCING HALL



FENCING HALL



CHEOPS HALL



PLACE FOR CATERING AND RELAX



REFEREE'S ROOM



STATUS OF PREPARATION (Individual participation)

KREMS (AUT) 2012

	645
AUS	17
AUT	41
BEL	3
BUL	1
CAN	11
CZE	12
FIN	4
FRA	59
GBR	69
GER	66
HUN	24
ITA	47
JPN	55
NED	12
POL	6
RUS	41
SRB	1
SUI	19
SVK	10
SWE	9
UKR	8
USA	70
<i>OTHERS</i>	<i>60</i>

VARNA(BUL) 2013

	616
AUS	8
AUT	17
BEL	4
BUL	21
CAN	15
CZE	5
FIN	7
FRA	60
GBR	70
GER	65
HUN	26
ITA	48
JPN	51
NED	7
POL	8
RUS	37
SRB	4
SUI	15
SVK	7
SWE	9
UKR	11
USA	71
<i>OTHERS</i>	<i>50</i>

DEBRECEN(HUN) 2014

	638
AUS	12
AUT	15
BEL	5
BUL	0
CAN	18
CZE	12
FIN	11
FRA	67
GBR	66
GER	67
HUN	35
ITA	53
JPN	50
NED	13
POL	5
RUS	36
SRB	4
SUI	17
SVK	9
SWE	11
UKR	10
USA	69
<i>OTHERS</i>	<i>53</i>

LIMOGES(FRA) 2015

	686
<i>AUS</i>	<i>12</i>
<i>AUT</i>	<i>16</i>
<i>BEL</i>	<i>8</i>
<i>BUL</i>	<i>0</i>
<i>CAN</i>	<i>18</i>
<i>CZE</i>	<i>12</i>
<i>FIN</i>	<i>11</i>
<i>FRA</i>	<i>70</i>
<i>GBR</i>	<i>70</i>
<i>GER</i>	<i>70</i>
<i>HUN</i>	<i>24</i>
<i>ITA</i>	<i>60</i>
<i>JPN</i>	<i>54</i>
<i>NED</i>	<i>15</i>
<i>POL</i>	<i>8</i>
<i>RUS</i>	<i>46</i>
<i>SRB</i>	<i>4</i>
<i>SUI</i>	<i>20</i>
<i>SVK</i>	<i>9</i>
<i>SWE</i>	<i>11</i>
<i>UKR</i>	<i>10</i>
<i>USA</i>	<i>70</i>
<i>OTHERS</i>	<i>68</i>

STATUS OF PREPARATION *(Teams participation)*

TEAMS in DEBRECEN					FHA	FHB	FHC	TEAMS	EHA	EHB	EHC	TEAMS	SHA	SHB	SHC	TEAMS	FDA	FDB	FDC	TEAMS	EDA	EDB	EDC	TEAMS	SDA	SDB	SDC	TEAMS	
638					57	36	35	9	83	53	44	13	43	34	30	9	35	26	15	5	39	29	16	6	29	23	11	5	
AUS	12			1					2	1				1	1						3								
AUT	15	4	1					2		2				1	2							1				1			
CAN	18	3	1	1	1			2	3	1	1										2				1				
CZE	12			1				1	2	1			1	2	2	1					1								
ESP	8	1		1									4												2				
FIN	11							1	1	2	1										3	2	1	1					
FRA	67	4	4	4	1			4	4	4	1		4	4	4	1	4	4	2	1	4	4	3	1	4	4	2	1	
GBR	66	4	4	4	1			4	4	4	1		4	4	4	1	4	4	3	1	3	4	3	1	4	4	1	1	
GER	67	4	4	4	1			4	3	4	1		3	3	4	1	4	4	4	1	4	4	4	1	4	3	3	1	
HUN	35	4	4	2	1			4	4	3	1		4	3	2	1	1				2	1				1			
ITA	53	4	4	3	1			4	4	4	1		4	4	3	1	4	1			4	3			4	3			
JPN	50	4	4	1	1			4	4	3	1		3	4	1	1	4	3	1		4	2	1	1	2	3	2	1	
NED	13	2						4	3				2				1				1								
RUS	36	4	2	2	1			4	4	2	1		3	3	1	1	3	1			1	2			3		1		
SUI	17	4		1				4	4	3	1											1							
SVK	9	1	2	2				1	2	1																			
SWE	11	2						4	1	1	1										2								
UKR	10	1						4	2	1	1				1				1										
USA	69	3	4	4	1			4	4	4	1		4	4	4	1	4	4	4	1	4	4	4	1	4	4	2	1	
Estimation in Limoges :								12				16				10				6				6				6	

STATUS OF PREPARATION (Timetable)

	Tuesday	Wednesday	Thursday	Friday	Saturday	Sunday
FOIL	42 B 35 C	56 A	12 TEAMS			
EPEE				56 B 49 C	84 A	16 TEAMS
SABRE		35 C	49 A 35 B	10 TEAMS		
FOIL			35 A	28 B 21 C	6 TEAMS	
EPEE	42 A	28 B 21 C	6 TEAMS			
SABRE					28 A 28 B 14 C	6 TEAMS
Total :	119	140	119	154	154	

STATUS OF PREPARATION (Scheduling)

➤ Example on Thursday:

EPEE		FOIL				SABRE							
Women TEAM		Men TEAM		Women "A"		Men "A"	Men "B"		Time	Dojo (5 pistes)	Fencing Hall (8 pistes)	CHEOPS (8 pistes)	
6	Pistes	12	Pistes	35	Pistes	49	35	Pistes					
		12	6	35	5				09:00		6	5	Poule
		12	6	35	5				09:30		6	5	
		12	6	35	5				10:00		6	5	T64
		12	6	35	5				10:30	2	6	5	
6	2	12	6	35	5				11:00	2	6	5	T32
6	2					49		7	11:30	2		7	
6	2	8	4	6	3	49		7	12:00	2	7	7	T16
6	2	8	4				35	5	12:30	2	4	5	
				32	4		35	5	13:00		4	5	
4	2	8	4	32	4	34		8	13:30	2	8	8	1/4
		8	4				6	3	14:00		4	3	
4	2			16	8	32		8	14:30	2	8	8	1/2
		4	2				32	8	15:00	2		8	
2	1			8	4	16		8	15:30	1	4	8	3rd match
		2	2				16	8	16:00	1	2	8	
2	1			4	2	8		4	16:30	1	2	4	F
		1	1			4	8	6	17:00	1		6	
				2	1		4	4	17:30	1		4	
						2		1	18:00	1			
							2	1	18:30	1			
MEDALS									19:00				

WEBSITE



[Championnats du monde
d'escrime vétérans](#)

[Limoges](#)

[2015
Bienvenue](#)



[World veterans fencing
championships](#)

[Limoges](#)

[2015
Welcome](#)





FIE VISIT (September)

Items :

- **Inspection of the premises**
- **Description of staff**
- **Global management**
- **Official functions**

See you soon in Limoges !





Veterans Council

**SUMMARY OF PROPOSALS AND
DISCUSSION**



Proposal 1 : Addition of 80+ age category

- To keep fencers in the late 70s to continue the sport and taking part in World Veteran Championship
- Proposing a test event in 2016 – subject to local host's capability and approval



Discussion : Addition of 40-49 age category

- Decided not to go ahead at this time
- Size of the event implication
 - Currently World Veteran Championships average 650+ entries
 - Possible addition of 300+ entries
- Age imperative not so pressing
- More research required



Proposal 2 : Review and comments on bids for
official veteran events



Proposal 3 : To allow FIE referees of over 60 years of age to referee Veteran Events

- Current rules state that referee tenure is up to 60 years of age
- Request to FIE to lift maximum referee age to 65 for Veteran events



Discussion : Tools and support for those wishing to introduce fencing to “older” people

- For new fencers and continuing fencers
- Health benefit – exercise etc
- A guide book on Health and Safety issues
- Outcome – to be posted on new website.



Proposal 4 : Veteran Council be upgraded to a Commission

- What is the process?



Introducing...

Cadet

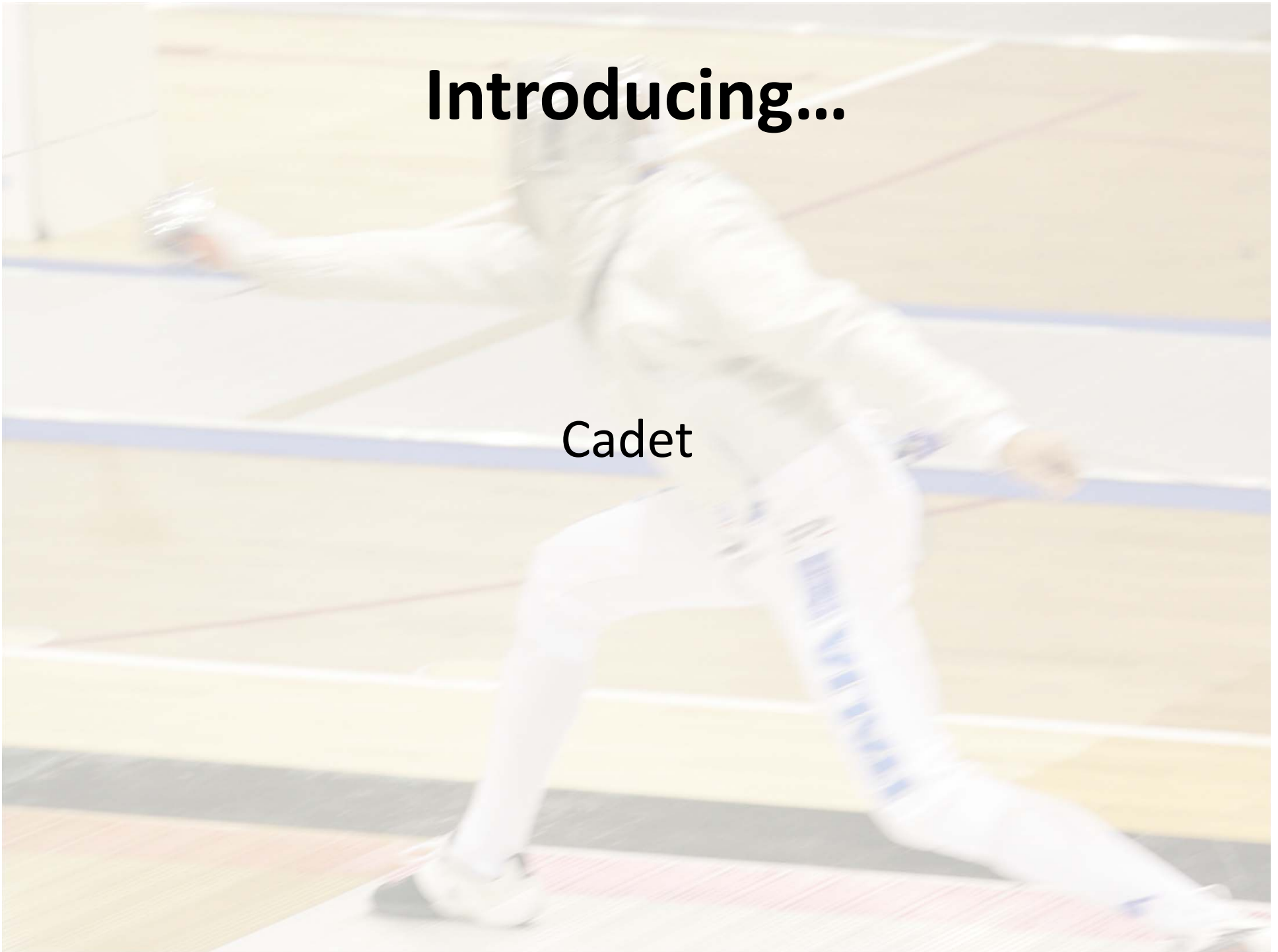

Introducing...

Junior

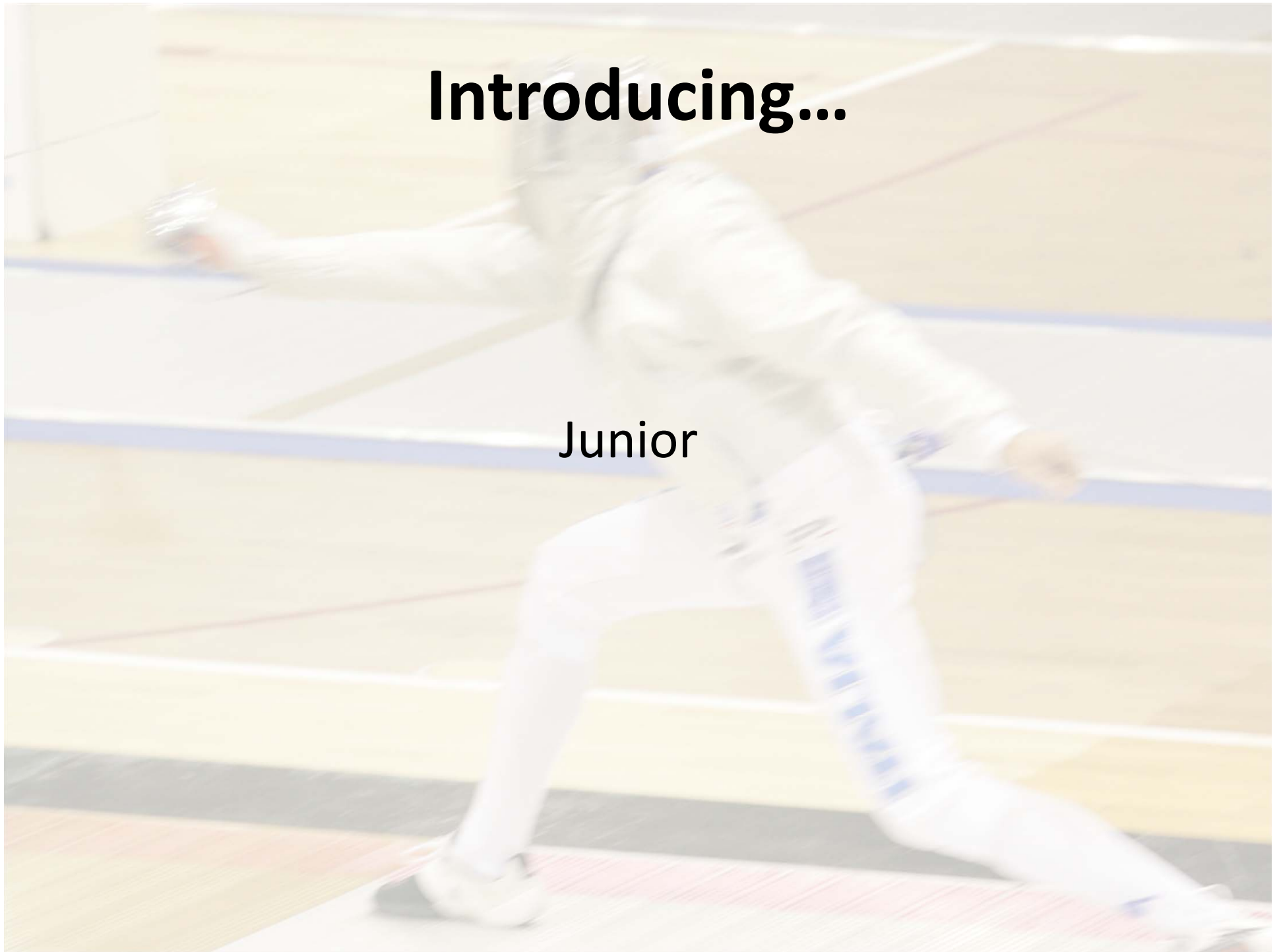

Introducing...

Senior

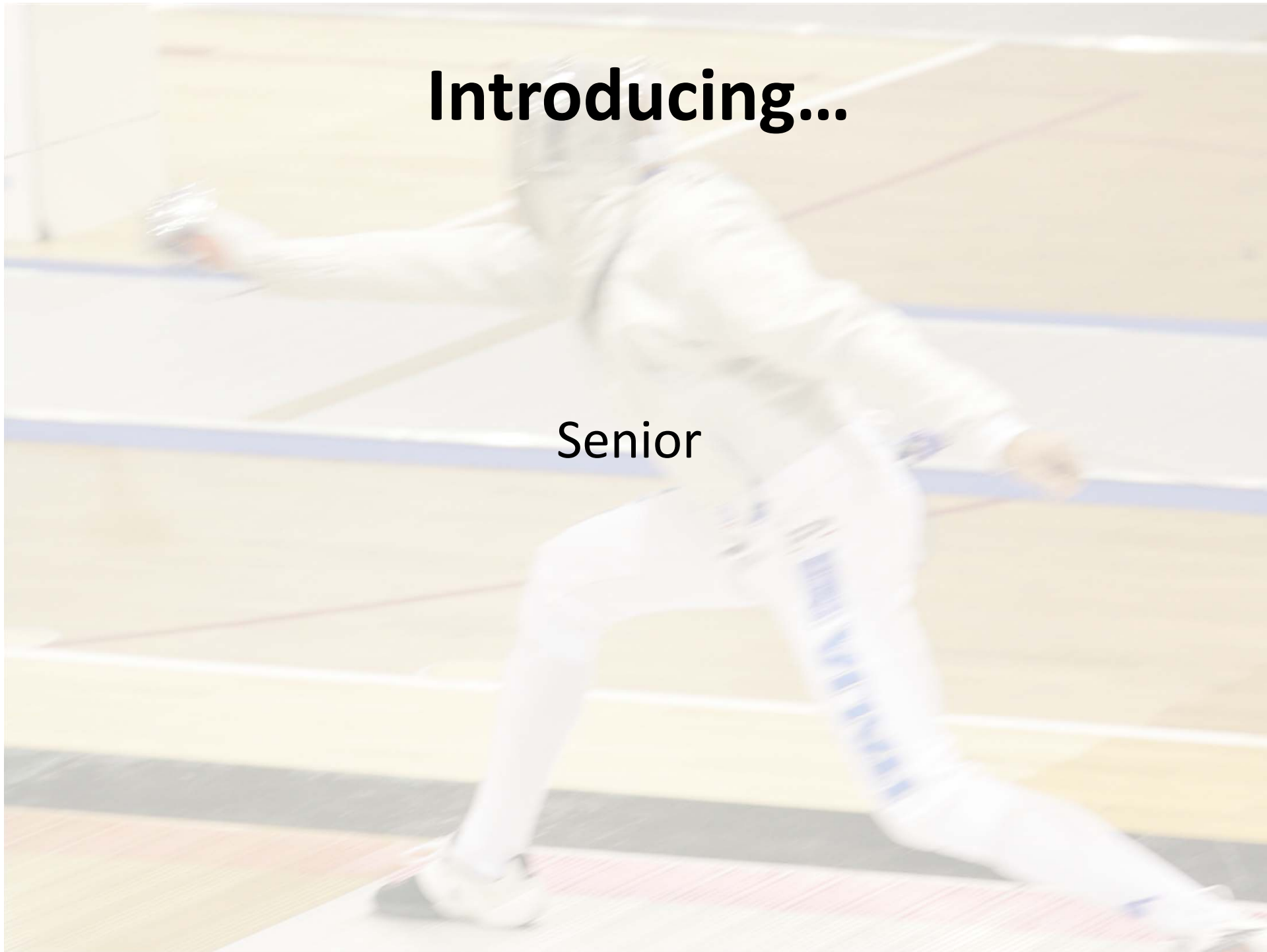

Introducing...



Introducing...



Fencing for Life

FIE Veterans Council DRAFT Proposals to COMEX

The Veteran Council would like to convey the follow proposals to the FIE COMEX for consideration.

Proposal 1: Introducing 80+ group in World Veteran Fencing Championships

Veteran Fencing so far has demonstrated the increasing number of people staying in the sport as they get older. Evidence shows, however, that fencers in their later 70s are dropping off a bit because they do not feel they can compete with the younger 70s. Providing 80+ gives them a reason to stay fencing. Subject to the local organiser there will be a test 80+ event at the 2016 Veteran World Championships

We would like the FIE to endorse this step with a view to formally acknowledging the 80+ group if the test event and feedback from fencers is positive.

Proposal 2: Changing from Council to Commission

The growth of Veteran Fencing has been significant since the creation of the Council and events are formally recognised by the FIE. The group provide expertise and guidance on a range of matters from event organisation, health and safety and special rules

We would like the FIE to acknowledge this group as a Commission of the FIE

Proposal 3: Input on Event Candidature

The group currently provides support and advice to those wishing to stage a Veteran World Championship. There are some conditions that are different from other events

We would like to be consulted on potential candidates so we can advise that they are appropriate for this cohort of fencers

Proposal 4: Change of name from Veteran to Senior*Plus*

It is unlikely that there will ever be complete agreement on a new name – however, most people agree that Veterans is not appropriate. Veterans is associated with military or animals and does not resonate with potential sponsors. Senior*Plus* is a good progression from Cadet, Junior, Senior.

We would like the FIE to formally adopt the name Senior*Plus* for fencers participating in events aimed at 40+

Proposal 5: Referees to 65 for Veteran events

There is a shortage of referees generally across all the age group competitions, as all populations grow older, referees at 60 are becoming more common but are still very much capable of refereeing Veteran events

We would like the FIE to formally recognise referees with still current skills to be able to officiate at Veteran events up to the age of 65.

1st August 2014
Bucharest, Romania

USA – Prepared by Rita Comes Whitney – Member of the FIE Veteran Council

The number of Veteran fencers in the US has increased over the last few years. The US continues to hold Veteran National Events along with other National Events at the same time so that the Veteran participants can participate in several events during a competition and the Veterans are not stigmatized as separate from other USFA members.

Current USFA Veteran Membership:

USA Fencing – Veteran Fencing Membership Data (as of 07/01/2015)

- Total Veterans (1975 and earlier): 5,564 compared to 5,398 in 2014

Summer National Veteran Participants

	2015 San Jose, California	2014 Columbus, Ohio
<u>V40ME</u>	51	38
<u>V40MF</u>	32	22
<u>V40MS</u>	21	24
<u>V40WE</u>	23	27
<u>V40WF</u>	18	22
<u>V40WS</u>	20	12
<u>V50ME</u>	79	67
<u>V50MF</u>	54	47
<u>V50MS</u>	31	32
<u>V50WE</u>	39	35
<u>V50WF</u>	32	31
<u>V50WS</u>	25	17
<u>V60ME</u>	48	50
<u>V60MF</u>	34	25
<u>V60MS</u>	24	14
<u>V60WE</u>	19	16
<u>V60WF</u>	16	12
<u>V60WS</u>	14	13
<u>V70ME</u>	15	16
<u>V70MF</u>	10	11
<u>V70MS</u>	12	11
<u>V70WE</u>	5	5
<u>V70WF</u>	4	6
<u>V70WS</u>	5	Canceled
Total	631	553

Team Participation

Team events have increased over the year. Competitions are continuing to add Veteran Team Events to local and Regional Events. This has been proved a successful addition marketing and monetarily for competitions.

Veteran Camps and Competitions

There has been a significant increase in Veteran Camps and Veteran Competitions across the United States with the USA Team doing extremely well. Many Veteran Fencers are able to attend camps and competitions around the world.

The Pan American Fencing Confederation will host the 2015 Youth and Veteran Pan American Championships August 3-8 at the Polideportivo Centro de Alto Rendimiento-VIDENA in Lima, Peru.

Team USA did very well in the Veteran World Championships located Hungary in the individual events and was able to excel during the Team Event.

Participation in the US is increasing in all veteran categories. There is interest in having an 80+ category by US fencers to increase continued participation by the 80 year olds so that they are no longer placed with the 70 year old group for pools.

Asia and Oceania – Executive Summary of Veteran Fencing in the Region

The number of Veteran fencers in the region has increased since the last report. Countries have now started to include veteran events in their National/Open Championships. Clubs have also started to organize veteran events and most interestingly together with Cadet and Junior competitions.

Veteran Team events are also increasingly being scheduled in competitions.

FCA set up their Veteran Council last year and the 1st T Asian Masters/Veteran will be held in Manila from 28th to 30th August 2015.

The next Commonwealth Veteran Fencing Championships will be in November 2016 in New Zealand.